

POWER PILFERAGE DETECTION AND IDENTIFICATION SYSTEM

By

Hasib Mahmudur Rashid
18121117

Md Musfiqur Rahman
17321004

Ajharul Hossain Tonmoy
18221049

Mahmud Yasin Prottay
17321024

A Final Year Design Project (FYDP) submitted to the Department of Electrical and Electronic Engineering] in partial fulfillment of the requirements for the degree of B.Sc in EEE

Academic Technical Committee (ATC) Panel Member:

Tasfin Mahmud (Chair)

Lecturer, Department of EEE, BRAC University

Md. Rakibul Hasan (Member)

Senior Lecturer, Department of EEE, BRAC University

Md. Mehedi Hasan Shawon (Member)

Lecturer, Department of EEE, BRAC University

Department of Electrical and Electronic Engineering
Brac University
December 2022

© 2022. Brac University
All rights reserved.

Declaration

It is hereby declared that

1. The Final Year Design Project (FYDP) submitted is my/our own original work while completing degree at Brac University.
2. The Final Year Design Project (FYDP) does not contain material previously published or written by a third party, except where this is appropriately cited through full and accurate referencing.
3. The Final Year Design Project (FYDP) does not contain material which has been accepted, or submitted, for any other degree or diploma at a university or other institution.
4. I/We have acknowledged all main sources of help.

Student's Full Name & Signature:

Hasib Mahmudur Rashid

18121117

Md Musfiqur Rahman

17321004

Ajharul Hossain Tonmoy

18221049

Mahmud Yasin Prottay

17321024

Approval

The Final Year Design Project (FYDP) titled “Power Pilferage Detection and Identification System” submitted by

1. Hasib Mahmudur Rashid (18121117)
2. Md Musfiqur Rahman (17321004)
3. Ajharul Hossain Tonmoy (18221049)
4. Mahmud Yasin Prottay (17321024)

of Fall, 2022 has been accepted as satisfactory in partial fulfillment of the requirement for the degree of B.Sc in EEE on December 15, 2022.

Examining Committee:

Academic Technical
Committee (ATC):
(Chair)

Tasfin Mahmud
Lecturer, Department of EEE
BRAC University

Final Year Design Project
Coordination Committee:
(Chair)

Dr. Abu S.M. Mohsin
Associate Professor, Department of EEE
BRAC University

Department Chair:

Dr. Md. Mosaddequr Rahman
Professor and Chairperson, Department of EEE
BRAC University

Ethics Statement

For our FYDP report format, we followed an IEEE Conference Paper inspired format suggested by our FYDP Committee and ATC panel. We also sought out an IEEE Open Journal Template from MS Word for a better understanding of the structure of our report.

We verify that this project, titled "Power Pilferage Detection and Identification System", satisfies the requirements for graduation and was developed and finished entirely from scratch. We worked hard to gather all of the information and materials and all the obtained data from other works have been properly referenced as well. The entire job was completed by us alone with the supervision of our respected ATC panel.

Throughout the report writing, our respected ATC panel members gave us valuable insight weekly on how to improve our structure based upon our research findings, data structure, and usage of tools, design efficiency and final design selection.

Abstract / Executive Summary

Energy Pilferage is a volatile activity that is hampering the socioeconomic growth of our country. Energy Pilferage is the act of illegally using unauthorized amount of power for individual gain. Local areas such as: households, small businesses steal energy directly from the distribution network causing major loss in terms or monetary compensation. Power pilferage takes several forms. Line tapping, meter tempering, and line bypassing are the most common. Local implementation methods include tempering electromechanical meters with foreign items, introducing a circuit to delay the meter, etc. Creative methods make durable solutions challenging. An effective monitoring system could prevent this ever happening. We have emulated a system by which real time data will be collected and later be used for the input for our DT (Decision Tree) algorithm to detect the possible theft patterns. The project's main goal is to ensure public access to clean, reliable power while eliminating unethical transmission and distribution activities (such as energy theft, improper device installation, customer nonpayment, accounting issues, etc.).

Keywords: Energy Consumption; Energy Theft; Power Pilferage; Decision Tree.

Dedication

We would like to cordially show my gratitude to our ATC panel members, Md. Mehedi Hasan Shawon Sir, Md. Rakibul Hasan Sir and our ATC chair, Tasfin Mahmud Sir for providing helpful insights when we were bewildered by the sheer amount of knowledge needed to complete this project. We would also like to express my humble gratitude to our FYDP Coordination Committee Chair Dr. Abu S. M. Mohsin Sir for providing the necessary guidelines during our progress presentation for better clarity.

Table of Contents

Declaration.....	i
Approval	ii
Ethics Statement.....	iii
Abstract / Executive Summary	iv
Dedication.....	v
List of Tables	viii
List of Figures.....	ix
List of Acronyms	x
Chapter 1: Introduction.....	1
Chapter 2: Project Design Approach	11
Chapter 3: Use of Modern Engineering and IT Tool.....	15
Chapter 4: Optimization of Multiple Design and Finding the Optimal Solution	25
Chapter 5: Completion of Final Design and Validation.	40
Chapter 6: Impact Analysis and Project Sustainability.....	44
Chapter 7: Engineering Project Management.	49
Chapter 8: Economical Analysis.....	53
Chapter 9: Ethics and Professional Responsibilities.....	58
Chapter 10: Conclusion and Future Work.	61
Chapter 11: Identification of Complex Engineering Problems and Activities.	63
References:.....	66

Appendix..... 71

List of Tables

Table 1.1: Specification & Requirements

Table 1.2: Codes, standards, and Refute table

Table 3.1: Modern Engineering/IT Tools Selection

Table 3.2: Load used for modeling of the prototype

Table 3.3: Consumption and state of the prototype loads

Table 4.1: Theoretical Optimal Design Selection

Table 7.1: Project Plan Time frame of EEE400-P EEE400-D and EEE400-C

Table 8.1: Initial Budget Plan

Table 8.2: Final Budget

Table 8.3: Comparison of Arduino Uno with Raspberry Pie-4, based on the specifications.

Table 8.4: Comparison of local and international PCBs with Vero Board, based on the specifications

List of Figures

Figure 1.1: Annual average energy use in Bangladesh [1]

Figure 1.2: 3D design of the device with Weather Protection Measures-1

Figure 1.3: 3D design of the device with Weather Protection Measures-2

Figure 2.1: Workflow of Design 1

Figure 2.1: Workflow of Design 2

Figure 3.1: Hardware Components of the project that will be used to capture Current and other required data.

Figure 3.2: The Hardware Circuit Diagram of the Power Pilferage Monitor Device

Figure 3.3: The real-time current data verification

Figure 3.4: Hardware Components of the project that will be used to capture Current and other required data.

Figure 3.5: When the regular load is coupled with a tolerance load.

Figure 3.6: When the connection for the bypass load is being made

Figure 4.1: Decision Tree Construction [17]

Figure 4.1: Decision Tree Construction [17]

Figure 4.3: Workflow of the ML Algorithm

Figure 5.1: Hardware Components of the project that will be used to capture Current and other required data.

Figure 5.2: DT Algorithm – 1

Figure 5.3: DT Algorithm - 2

Figure 5.3: Sample data [\[18\]](#)

Figure 7.1: Gantt Chart

Figure 8.1: Arduino Uno Microcontroller Board Price at Daraz Online Shop, Roboticsbd Online Shop and Local Shops

Figure 8.3: Estimated cost difference of Raspberry Pie and Arduino Uno

List of Acronyms

NTL	Non-Technical Losses
TL	Technical Loss
ML	Machine Learning
SMOTE	Synthetic minority over-sampling technique
AMI	Advanced Metering Infrastructure
SM	Smart Meter
DM	Digital Meter
PLC	Programmable Logic Controller
DPDC	Dhaka Power Distribution Company
PCB	Printed Circuit Board
DT	Decision Tree
PE	Expected Power
RF	Random Forest
IRB	Institutional Review Board for each institution
PGCB	Power Grid Company of Bangladesh
DESCO	Dhaka Electricity Supply Company
BPDB	The Bangladesh Power Development Board

Chapter 1: Introduction

1.1.1 Problem Statement

Bangladesh is currently able to provide itself with self-produced electricity completely. The total consumption of electricity energy of Bangladesh is 53.65 billion kWh per year [1]. In terms of per capita it is 326 kWh on average. The total production of all electric energy producing facilities is 61 billion kWh. It is 113% of its own requirements [1]. The rest of the self-produced energy is either exported into other countries or unused. Even though we produce excess energy there is still load shedding and shortage of electric energy. This scenario can be easily avoided if there was a proper monitoring system. The theft of energy occurs when the energy gets distributed through local grids to electric poles to household and small industries. Due to little to no monitoring in these small sections, unauthorized consumption units emerge. So, more than necessary energy is misused. This unauthorized use of electric energy is causing our country major financial loss. There are various ways power theft happens. Among them the most popular methods are:

- Line tapping
- Electric Meter tempering
- Line bypassing

Each of these methods even has their own local implementation methods, for example: Tempering electromechanical meters with foreign objects, injecting a circuit in the meter to slow the meter etc. Because of these creative ways, a stable solution is really difficult.

1.1.2 Background Study

There are many ways some malicious activity can happen in our daily energy consumption networks. The basis of the any theft related activity is the intention to forge. Here is a pilferage system represented as a tree explaining how the forging actually happens.

All the research for this project was done during the project selection period. There were a plethora of journal papers and studies we had to go through to come to a general understanding of the topic. Initially, we only selected the topic and were mostly novice to the definition of power pilferage. So, we did our research and understood about the concept of NTL (Non-Technical Losses) and electricity pilferage is a major part of NTL [2]. We also found out the self-produced power of Bangladesh is more than what our country needs [1]. Further research regarding the situation of electricity pilferage in Bangladesh revealed that on weighted average more than one-third (~14%) of the system loss happens due to pilfering and unauthorized power usage [3]. Customer load profile analysis is a commonly used technique for identifying fraudulent actions [4]. These strategies, however, are not able to identify energy thefts wherever meters have been totally disregarded. When this occurs, theft detection is based on losses estimated by balancing the energy supplied by the distribution transformer with the

energy used by consumers. The TL and NTL elements of these losses must always be carefully calculated in order to identify power thefts. [5] presents a model for determining TL, however, it needs topological data from the primary and secondary networks.

1.1.3 Literature Gap

We have assessed multiple literature papers, journals, conference papers, research articles etc. to get set a standard to work from. The following will discuss about the papers we reviewed, their features and how do they correlate with our necessities:

Paper Review 1: Wireless power meter monitoring with power theft detection and intimation system using GSM and Zigbee networks. [6]

Features:

1. Wireless based power pilferage detection system
2. Using gsm module

Paper Review 2: Reducing Electricity Pilferage by Low Frequency Control Scheme in Bangladesh. [7]

Features:

1. Using zigbee network with high bandwidth frequency
2. WIFI is widely available to general masses and easy to implement as well

Paper Review 3: Smart Power Theft Detection System. [8]

Features:

1. This is a power pilferage detection system with a proper database to store collection of data.
2. It can detect the location of pilferage occurring.

Paper Review 4: IoT Based Power Pilferage Detection. [9]

Features:

1. This power pilferage system built in IoT interface.
2. This ensures interconnectivity between components

Paper Review 5: Effective Electricity Pilferage Detection in Power Distribution Grids Using an Adaptive Neuro Fuzzy Inference System. [10]

Features:

1. This paper introduced meter tempering prevention
2. Wireless data monitoring system

Paper Review 6: Ensemble Machine Learning Models for the Detection of Energy Pilferage [11]

Features:

1. In this paper, power pilferage is detected by machine learning
2. This system has more accuracy as machine learning is used

Paper Review 7: Decision Tree and SVM-based Data Analytics for Theft Detection in Smart Grid. [12]

Features:

1. This paper is using data decision tree in machine learning
2. Has more accuracy because it compares more data.

Paper Review 8: Electricity Theft Detection in Smart Grid Systems: A CNN-LSTM Based Approach. [13]

Features:

1. In this paper, CNN-LSTM-based deep learning techniques are used for pilferage detecting from power consumption pattern
2. Synthetic minority over-sampling technique (SMOTE) is used in this design

After analyzing all these researches, we now have a standard where we can start to work our way to our expected design. Our target is to create a system which will be suitable for our own country's energy distribution system. So, we need to do necessary advancements and changes to make it possible. As we discussed before, due to huge energy demand it is often difficult to maintain proper outlook on the energy usage. By using this loophole ill-doers are attempting illegal activities by tempering the line creating energy crisis. All the above researches work with AMI (Advanced Metering Infrastructure) which consists of networks of multiple SM (Smart Meter) instead of DM (Digital Meter) which is an issue for our requirements. Our country has yet to fully optimize the SMs in all households so most of the households are still using DMs. So, we need to think about our design in this regard.

1.1.4 Relevance to current and future Industry

Electricity pilferage is a crime offence and it is growing day by day by not giving sufficient attention. In our project, we have completed a design which can detect power or electricity pilferage from distribution line to house meter. We found an article that says 156.65 rupees crore worth of electricity pilferage is detected in 2021-22 [14].

So, if the power pilferage device can be implemented in proper way, power pilferage rate can be reduced. Saving electricity has a great relevance to current situation and also to future situation.

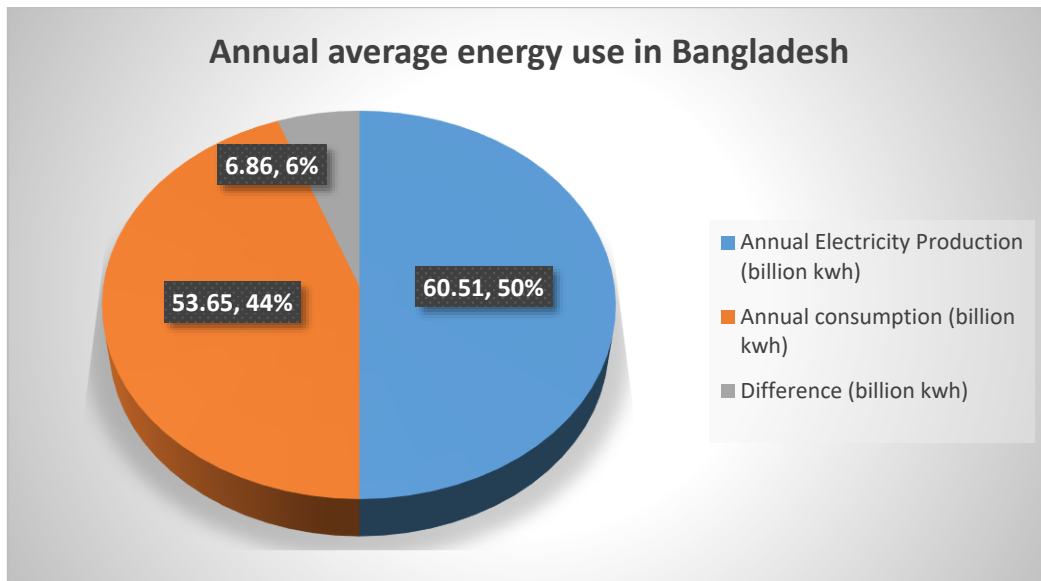

Figure 1.1: Annual average energy use in Bangladesh [1]

Here, it can be observed that total electricity production is 60.51 billion kWh, while total energy consumption is only 53.65 billion kWh; the problem emerges when the discrepancy is 6.86 billion kWh. If we can save electricity loss or illegal usage, then electricity generation will be less and environment will be less polluted by coal burning, fuel burning etc. Implementing proper pilferage device can also bring a great economic impact in our country. Saving electricity can introduce to ensure electricity in everywhere and load shedding can be reduced more.

1.2 Objectives, Requirements, Specification, and Constraint

1.2.1. Objectives

The aim of this project is to avoid any kind of immoral activities containing, Energy fraud, Device installation error, Nonpayment of consumers, Accounting errors, etc., from transmission to distribution line and maintain a sustainable clean power supply to general masses. However, our future endeavors regarding this project will include significant improvements: Smart meter-based power monitoring with or without machine learning, locating the exact position of line tapping and bypassing. Here are the current objectives of our project:

- To create a system using financially affordable materials and equipment which will be able to identify and measure any power pilferage between a supply unit and consumer unit.
- To create an effective simulation process for better management.
- An effort to save millions of dollars that goes to waste due to faulty detection process.

1.2.2 Functional and Nonfunctional Requirements and Specifications

Table 1.1: Specification & Requirements

System	Sub-system	Requirement	Components	System
User Side	Terminal	<p>The device which will be connected to user's electric meter.</p> <ul style="list-style-type: none"> Monitors the current entering the electric meter. Sends the data to Computer 	<ul style="list-style-type: none"> Arduino Uno R3 ACS712, Current Sensing Module SIM900L GSM Module LCD Display Buzzer Energy Meter Microcontroller connector cables for data collecting 	<ul style="list-style-type: none"> CodeVisionAVR Arduino IDE Python IDE Microsoft Excel
	Protective Case	<p>To give the device a proper skeleton:</p> <ul style="list-style-type: none"> Will protect the device from sudden assault (e.g: Ramming, Falling) Electric shock proof 	<ul style="list-style-type: none"> Plastic Box Screws 	
Data Storage	Server	<ul style="list-style-type: none"> Will act as a server for all the data sent by the Mother terminal and Child Terminal. Needs to keep running 	<ul style="list-style-type: none"> Monitor Keyboard Mouse Computer Core i3 processor 8GB RAM 500GB HDD 	<ul style="list-style-type: none"> Windows 10 OS Python IDE Python 3.10.6 Colaboratory

		all day and night.		
--	--	--------------------	--	--

Non-Functional Requirements:

Weather Protection Measures:

Our mother terminal will connect to a transmission pole. So, it will be exposed to the environment daily. Any bad weather can damage our device. So, we will construct a contraption with plastic racks and waterproof sheets so the device may stay safe when natural disasters happen.

- The device will remain dry during rain
- It will keep the device cool during a heat wave
- Dust and small flying debris will not damage our circuits



Figure 1.2: 3D design of the device with Weather Protection Measures-1

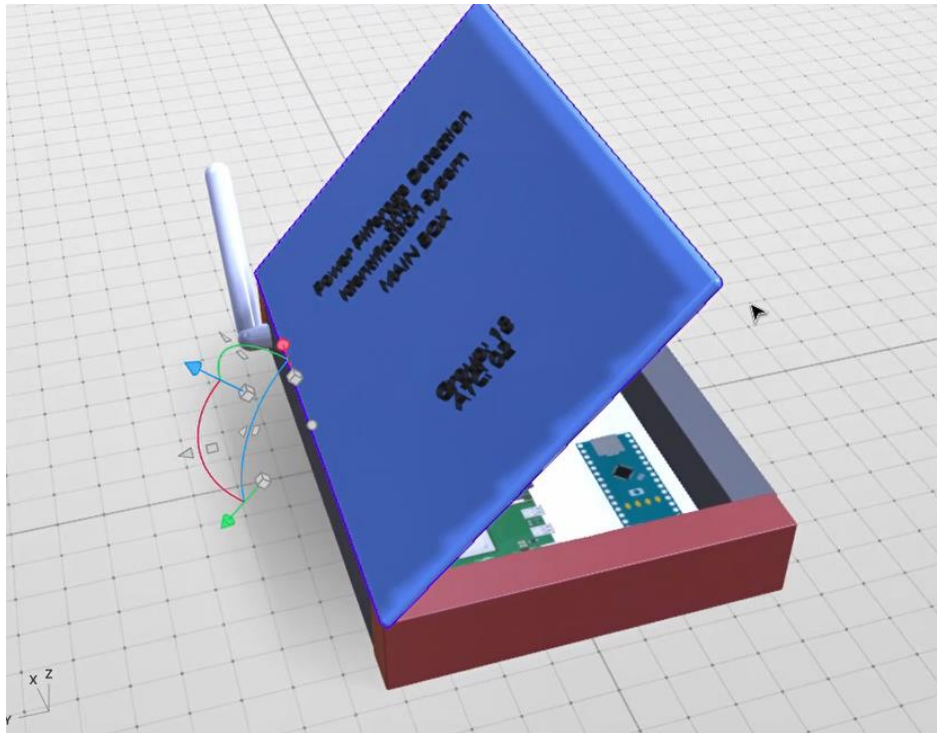

Figure 1.3: 3D design of the device with Weather Protection Measures-2

Separate Server Room Selection:

Because all of our information will be saved on a dedicated server, we need a location that is both safe and reasonably priced in order to maintain the server up around the clock. Therefore, it is possible that we will need to lease a small office space for our desktop computer so that we can keep track of the data while also transmitting it to our machine learning system so that it can be further processed.

1.2.3 Technical and Non-technical consideration and constraint in design process.

Constraints:

Functional Constraints:

Users of this system will have the ability to watch real-time monitoring of the voltage and current via this system. Therefore, the first limitation is to develop terms and conditions for the data storage that are accessible to users and that must protect their privacy while maintaining a consistent user experience.

- The user's preference for installation space. We have to abide by the rules of the user in terms of where they want to place the system.

Environmental Constraints:

The environmental limits that our project must adhere to, which are outlined in the following paragraphs, have the potential to adversely damage both the prosthesis and the environment.

- Any form of electronic gadget is at risk of being harmed by water on a fairly regular basis.
- A severe storm may have an impact on the gadget that controls our transmission line.
- In the long term, a wireless network that is cluttered with interference might be detrimental to the economy.

Legal Constraint:

One of the legal complications that arise from our activity is the need that we have legal rights and responsibilities. We have encountered when gathering data.

- In order to train our device, we need certain data to be converted from DPDC to which might be difficult.

Safety Constraints:

Any human person has the potential to do harm, and there is also the risk of receiving an electrical shock. The following are some of the potential hazards:

- Any individual who is not authorized to use the equipment might do harm to it.
- Because this is an electrical gadget, there is always the possibility of it having a short circuit.
- The likelihood that the gadget can be hacked.

1.2.4 Applicable compliance, standards, and codes

Table 1.2: Codes, standards, and Refute table

Codes	Standards	Refutes
1451.0-2007 - IEEE	Standard for a Smart Transducer Interface for Sensors and Actuators	Our sensors are capable of taking input current and give appropriate output
1118.1-1990 - IEEE	Our sensors are capable of taking input current and give appropriate output	Our microcontrollers are operating only one GSM Module per unit so there is not much load on the microcontroller initially
1101.4-1993 - IEEE	Standard is to use military module	We did not use any military module nor do we intent to use it for military purposes
NFPA 10	Standard for Portable Fire Extinguishers	We will encourage the user to keep licensed fire extinguishers
ISO/IEC 29184:2020	Online privacy notices and consent	Users have choice to accept or decline our Terms and Conditions while using the mobile app

1.3 Systematic Overview/summary of the proposed project

The method of developing the design via keeping a systematic overview, which was carried out in an appropriate manner for the proposed project, will be explained below;

- **Conceptual Design:**

At this point, in the process of developing this project, we have drafted a conceptual design with all equipment concepts that are based on the findings of market research, such as concept testing, and the requirements of the product.

- **Design Analysis:**

As soon as we concluded with the conceptual design, our primary objective was to evaluate the effectiveness of the model that we would want to ultimately put into practice. In order

to confirm that everything worked as it should, we consulted the Proteus file for assistance. The very last step in this part was the use of machine learning. For the purpose of data collection, we utilized kaggle.com.

- **Data Selection:**

Once we were satisfied with the performance of our design, we moved on to collecting our very own data. After the first effort to properly gather data for the load-shedding issue at that time was unsuccessful, we ultimately obtained data from the 3 meters in Bogura, Bangladesh, and then collected data from the 2 meters in Dhaka, Bangladesh, for accurate representation of the situation. In later stages, when we did not have access to accurate data on the seasons and temperatures, as well as when we did not have information regarding all of the appliances, we once again got the data from a worldwide open source.

- **Engineering Drawing:**

To finalize the positioning of our Printed Circuit Board (PCB), energy meter, and sensors on the intended board, we turned to engineering drawings for assistance. Where we were going to set up the equipment that would collect our data.

- **Prototyping:**

After we had finished creating all of the simulation files, we began to piece together our project in order to give it an overall appearance that was finished. This was the most difficult component because we had to take the pulse from the meter and then, with the assistance of PC817, we transferred it to the microcontroller. Furthermore, in order to measure the current in real-time, we used a different microcontroller and sensor, which had to maintain a connection with the computer at all times.

- **Finalized Implementation:**

Following the completion of the prototype stage, we consolidated all of the individual components into a single device and started using it as a genuine data-collecting instrument. In order to get the result, we want, we further used our machine learning system to evaluate the data.

1.4 Conclusion

The project's overarching objective is to safeguard the public's access to a reliable, clean power supply while eliminating unethical practices along the transmission and distribution lines (such as energy theft, improper device installation, customer nonpayment, accounting issues, etc.). There will be major improvements to this project as a result of our future work. Smart meter-based power monitoring, with or without the use of machine learning, identifies the exact position of line tapping and bypassing.

Chapter 2: Project Design Approach

1.1 Introduction

We have gone through various design ideas after evaluating the similar research papers. After extensive consideration we have selected two multiple design approaches for our project. Each of the design is although similar in nature, they have different functional requirement which separates them from each other.

1.2 Identify multiple design approach

Design 1: Pilferage detection through a Desktop PC: This design deals with server interfacing as its core. We will use microcontroller and GSM module to send data to server where data will be stored to later be classified and used as input for our smart data analysis.

Design 2: Pilferage detection through Raspberry Pi module: This design almost has the same working principle but instead of using a server as the base for training algorithm we will use a Raspberry Pi module to use an already trained model to detect any suspicious activity on the user side and send the data to a server afterwards.

1.3 Describe multiple design approach

Design 1: Pilferage detection through a desktop PC:

- Uses real-time data to detect malicious customers.
- Uses two Arduino Uno and a GSM Module for efficient flow of collected data.
- Node.js maintained server to collect data.
- Uses C4.5 algorithm to construct a DT (Decision Tree) to calculate PE (Expected Power)
- Estimated cost is around 4500taka.

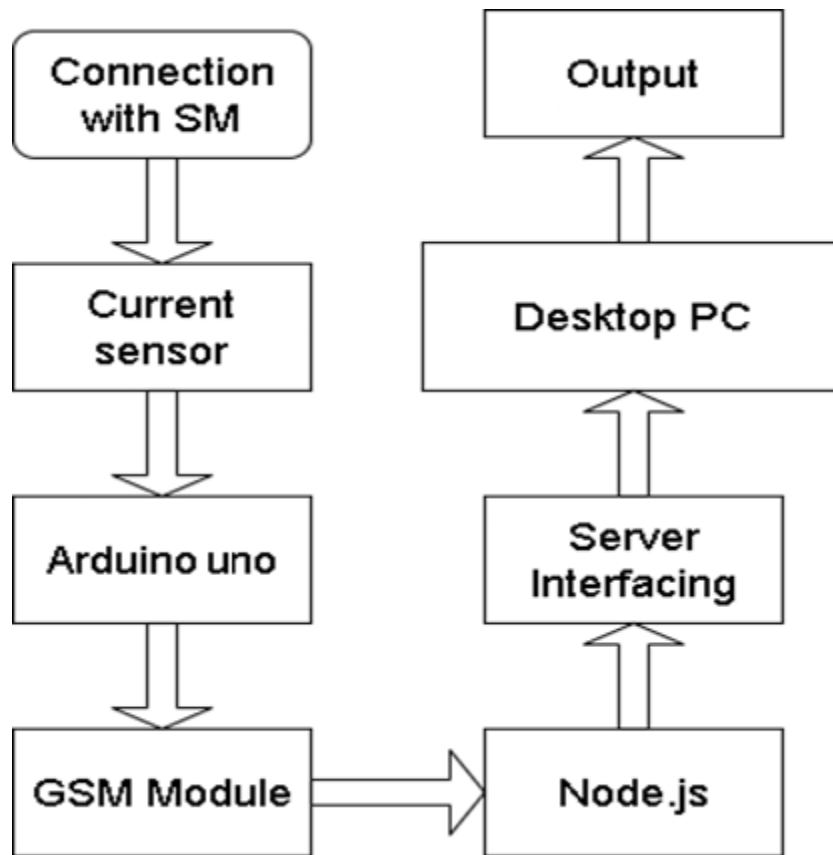

Figure 2.1: Workflow of Design 1

Design 2: Pilferage detection through Raspberry Pi module:

- Uses both real time and collected data to detect malicious activity.
- Uses one Arduino Nano, GSM Module to maintain the flow of collected data
- A Raspberry Pi is used to store a trained algorithm to detect the theft at the user side.
- The resultant output is also sent back at the server for later evaluation.

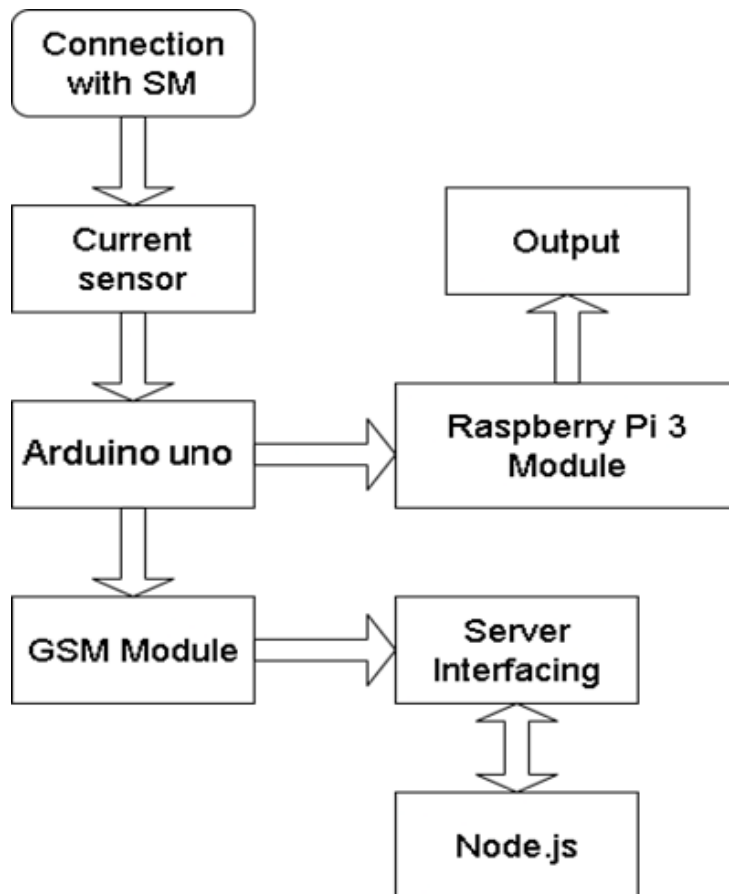

Figure 2.1: Workflow of Design 2

1.4 Analysis of multiple design approach

Design 1: Pilferage detection through a desktop PC: This system uses one Arduino Uno R3 and a ACS712 to detect the current entering the electric meter. Then value of current is sent to the server via GSM800L and another Arduino Uno R3. Then the amount of current or the actual power entering the meter is compared with the PE generated from the DT algorithm to look for any malicious activity. The data is also sent to a central server for scrutiny and classification.

Design 2: Pilferage detection through Raspberry Pi module: This system consists of an Arduino Nano and a current sensor (AC712) to detect the amount of current coming into the meter. In the server, using the collected data samples for the Machine Learning (Oversampling and Bagging) are generated and later used to evaluate the theft patterns of that certain area.

1.5 Conclusion

Both of these designs represent a better, efficient way from all our previous concepts combined. The fundamental design for both of the approaches is shown near flawlessly in this section. A more in-depth analysis is represented at the next chapters.

Chapter 3: Use of Modern Engineering and IT Tool.

1.6 Introduction

Here, several sorts of components were used and evaluated to assure the project's operation. This design adhered to a simple schematic to keep the components in accordance with the applicable regulations. In order to have a foundational understanding of the whole process, an initial plan was developed. Continuing with the design, a full circuit diagram was constructed later on.

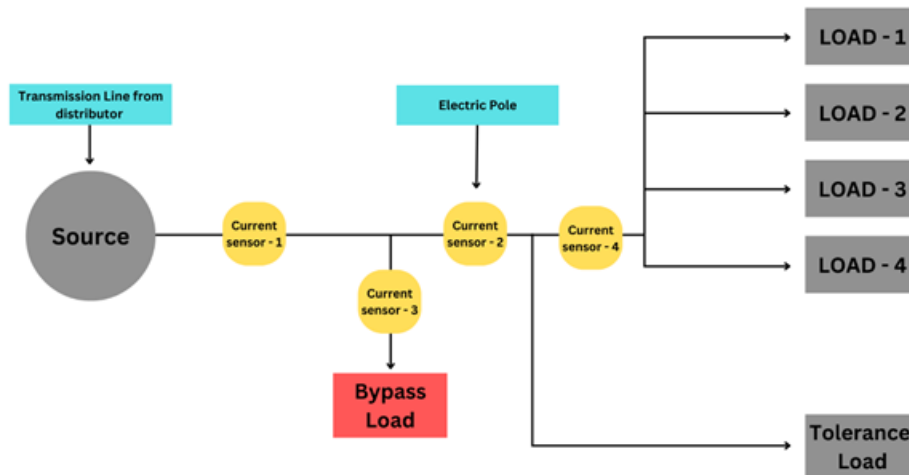

Figure 3.1: Hardware Components of the project that will be used to capture Current and other required data.

Regarding the analog analysis, this design was subjected to two situations to establish whether or not there is abnormal activity or theft occurring.

For condition 1, we can observe five loads and a tolerance load on the right user side. Current sensor-2 will be attached to these loads. The obtained data will be exported to a .csv file using Microsoft Excel. In the future, these statistics will be uploaded to a machine-learning system to detect any odd behavior.

Even if Condition 1 fails, it is still feasible to detect any unethical behavior by comparing Current sensor-2 with Current sensor-1, as stated in Condition 2. However, it is essential to determine if there are any minimum system losses that will be regarded as acceptable.

1.7 Select appropriate engineering and IT tools

Table 3.1: Modern Engineering/IT Tools Selection

Hardware Section		
Sl	Components	Working Principles
1	Arduino Uno Microcontroller Board	Here it was used because, Arduino is a free, versatile, and user-friendly electronics creation platform built on open-source hardware and software for creators and developers. This platform permits the creation of several sorts of single-board microcomputers, which the community of creators may put to various uses.
2	GSM Sim800L	The SIM800L GSM module is a compact GSM modem that may be included in a variety of Internet of Things applications. This module can do almost every function a standard mobile phone can, including sending SMS messages, making phone calls, and much more, this is the main reason to use this module.
3	16×2 LCD Display	The primary reason for using this module is, LCD 16x2 refers to an electronic device used to show data and messages. As its name implies, it consists of 16 Columns and 2 Rows, allowing it to show 32 characters ($16 \times 2 = 32$) in total, with each character consisting of ($5 \times 8 = 40$) Pixel Dots. Therefore, the total number of pixels in this LCD may be computed as 32×40 , or 1280 pixels.

4	Electricity Energy Meter	This equipment was taken to analyze the pulses according to use. The primary role, however, is to monitor the kilowatt-hour (Kwh) consumption of a certain region. This gadget is also capable of monitoring current and voltage in real-time.
5	Optocoupler PC817	PC817 is also known as an opt isolator and optocoupler. It is made up of Infrared Emitting Diode (IRED). This IRED is optically connected to a phototransistor rather than electrically. It is packaged with four (4) pins. This packaging often comes in two distinct varieties. This device is used to receive and transmit pulses to the microcontroller.
6	Buzzer	Being an audible signaling device, buzzer is used to inform users of a certain operation.
7	1-Channel 5v Relay	The 1 Channel 5V Relay Module offers a relay that may be operated by any microcontroller 5V digital output. It is intended to enable Arduino to manage this project's single high-powered device.
8	Resistors: 100 ohms, 4.7k Resistor, 1k Resistor, 10k Resistor,	A resistor is used to slow the flow of electricity and lower the voltage, it takes in energy and releases it as heat.
9	Wires	Many types of wires were used to complete the operation according to the diagram.
10	AC Loads	Various AC load types were connected to approximate the actual circumstance.

11	5v Power Adapter	All the DC equipment was powered by a 5-volt, 2-amp Power Adapter. For varying loads, a DC Buck was tasked with the responsibility.
12	Limit switch	Limit switches are electromechanical devices that consist of a mechanically connected electrical switch and an actuator. When an item meets the actuator, the switch will activate, making or breaking an electrical connection. For instance, when an individual attempted to uncover the meter, it activated the buzzer and operated the relay to cut off the power supply.
13	ACS712	The ACS712 is a fully integrated Hall effect-based linear current sensor with 2.1kVRMS voltage isolation and an integrated low-resistance current conductor. Aside from the technical terms, it is just described as a current sensor that uses its conductor to figure out and measure the amount of current being used. The used sensor has an input range of up to 30A and can measure in real-time. From this sensor, it's easy to get all the data and send it to Microsoft Excel to be turned into a .csv file.
Software Section		
14	Arduino Software	Using Arduino IDE, the code was written to do the required operations. During compilation, the necessary code modifications were made to achieve the intended outcome. The operation was concluded as a result of designing and simulating the identical circuit in Proteus.
15	Machine Learning	For Machine Learning System, we've used Python IDE, Python 3.10.6, Microsoft excel and Colaboratory to process and check our operation time to time.

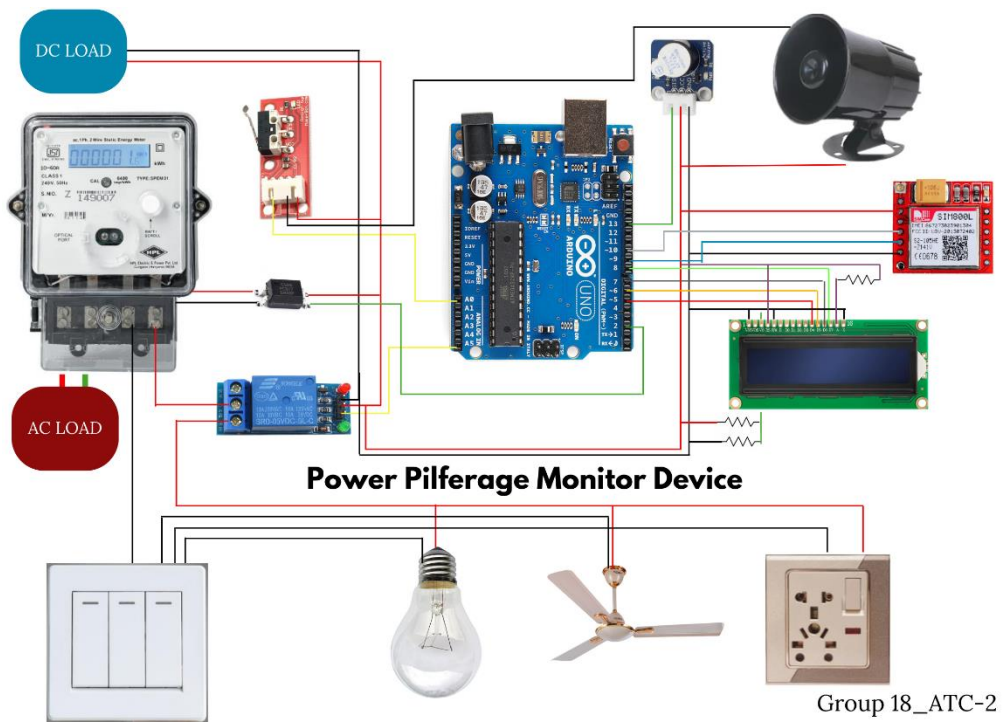

Figure 3.2: The Hardware Circuit Diagram of the Power Pilferage Monitor Device.

1.8 Use of modern engineering and IT tools

There are several methods for stealing electricity, but tapping and bypassing are the most common. Bypassing accounts for eighty percent of global theft [15]. The average annual power loss documented by the electrical board was 20-30% [16]. This project's objective is to audit any power taken in before the energy meter, which is considered power theft, in an effort to reduce the amount of money spent on electricity. This will result in the identification of the energy meter by sending an SMS to the relevant authorities. A current sensor is used to determine the difference between input and output power when a tolerance and bypass load are present. An Optocoupler PC817 is also included to detect the pulses.

Here, multiple loads were connected before the energy meter to represent a particular region, while the bypass line was attached. When the bypass line is activated, the energy meter's Micro-Controller starts to detect variations in the real load's power supply. Immediately, a notification identifying the power theft is shown as Status: Abnormal on the LCD. In addition, the information from the Micro-Controller via the SIM800L delivers the report as an SMS to the two users that previously was recorded as mobile number on the Micro-Controller.

For example, let some loads taken as,

Table 3.2: Load used for modeling of the prototype

Sl	Loads	Current/ Ampere
1	No Load	0.060
2	Load 1	0.930
3	Load 2	0.960
4	Bypass	0.108
5	Load 1 + Load 2	1.890
6	Load 1 + Load 2 + Bypass Load	1.980
7	Load 1 + Load 2	1.890
8	Load 1 + Bypass Load	1.038

In this point, the Power Pilferage Monitor will display a value of 0.060 while there is no load, with subsequent loads displaying as follows: Load-01: 0.930, Load-02: 0.960 (Tolerance), and the Bypass Load: 0.180. After being processed using the code that we have provided, the outcome will reflect the input in the appropriate manner.

Table 3.3: Consumption and state of the prototype loads

SI	Current/ Ampere	Status
1	0.060	Normal
2	0.930	Normal
3	0.960	Normal
4	0.108	Abnormal
5	1.890	Normal
6	1.980	Abnormal
7	1.890	Normal
8	1.038	Abnormal

The status bar adjusts its appearance in response to the user's input and shows the user an accurate depiction of that information. In order for the user to be able to execute inspection when the status becomes aberrant.

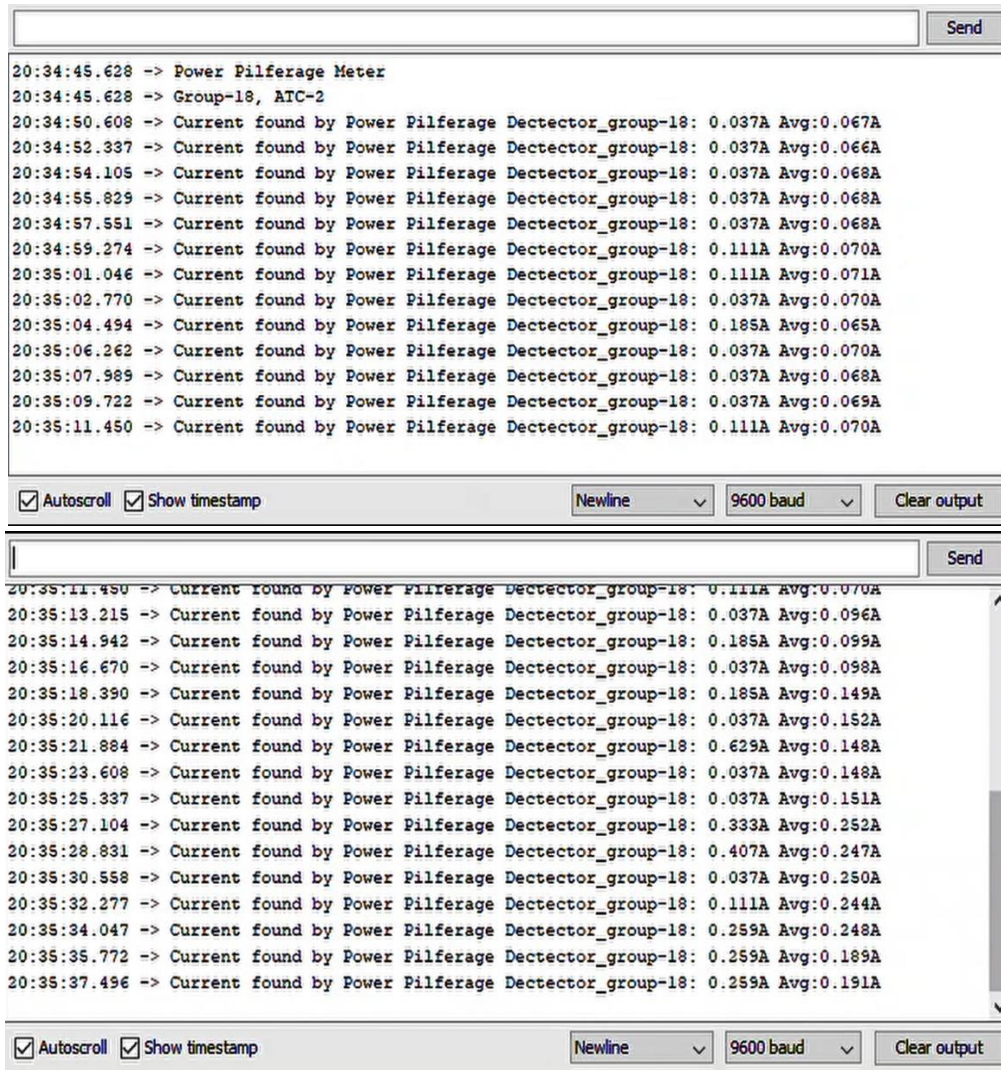

Figure 3.3: The real-time current data verification

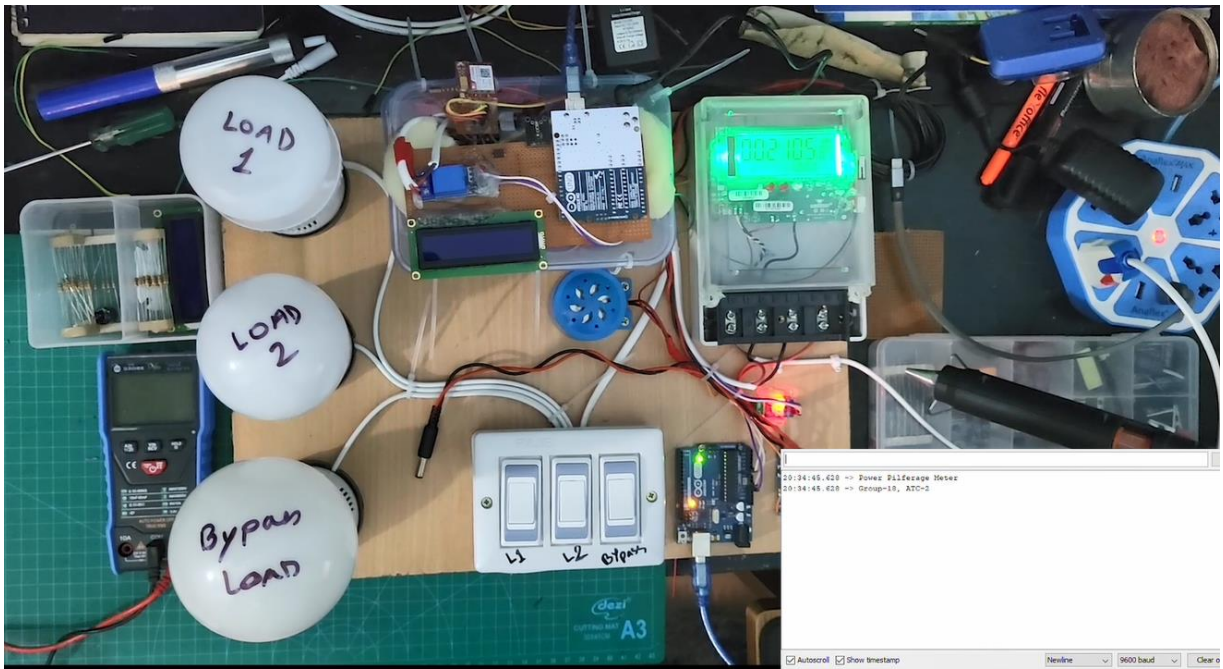

Figure 3.4: Hardware Components of the project that will be used to capture Current and other required data.

Chapter 4: Optimization of Multiple Design and Finding the Optimal Solution

4.1 Introduction

Both of the design ideas were modified and revision under alternative components to ensure the most efficiency. We found out some significant differences between our two designs in terms of optimization. Since our hardware part is almost similar so optimization issue is mainly in the machine learning section is both of these designs.

4.2 Optimization of multiple design approach

Design 1: Pilferage detection through a desktop PC

In Design 1 we used DT to generate a PE then compared this with the actual real time data collected to identify possible pilferage. The decision tree algorithm is as follows:

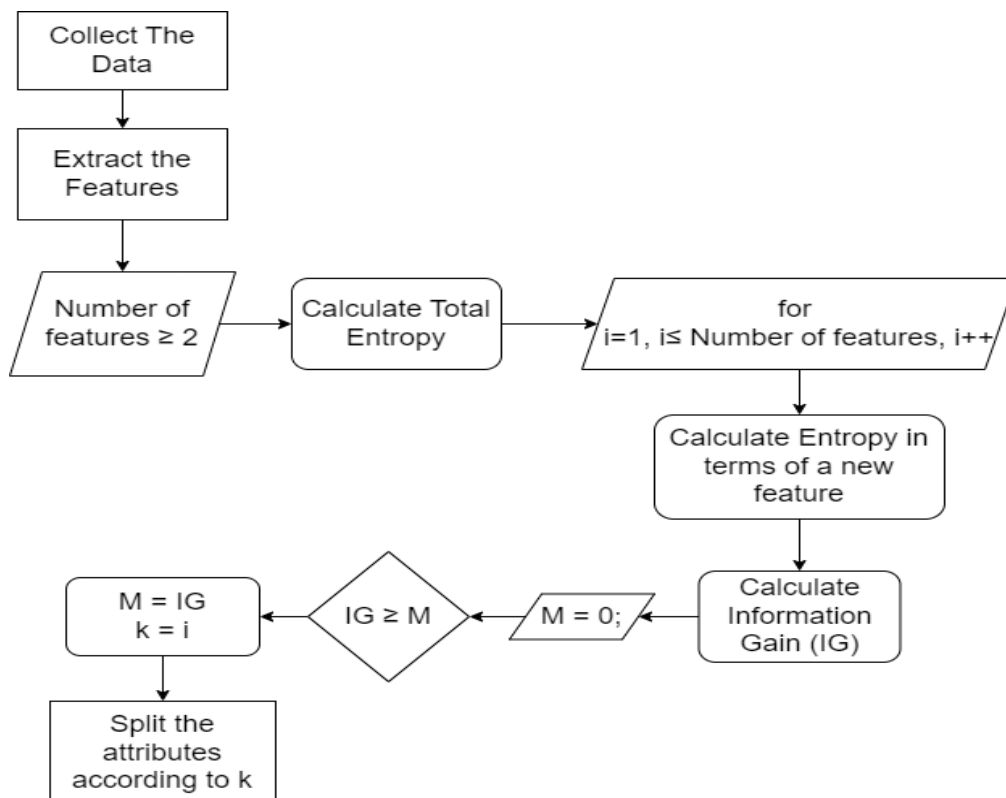

Figure 4.1: Decision Tree Construction [17]

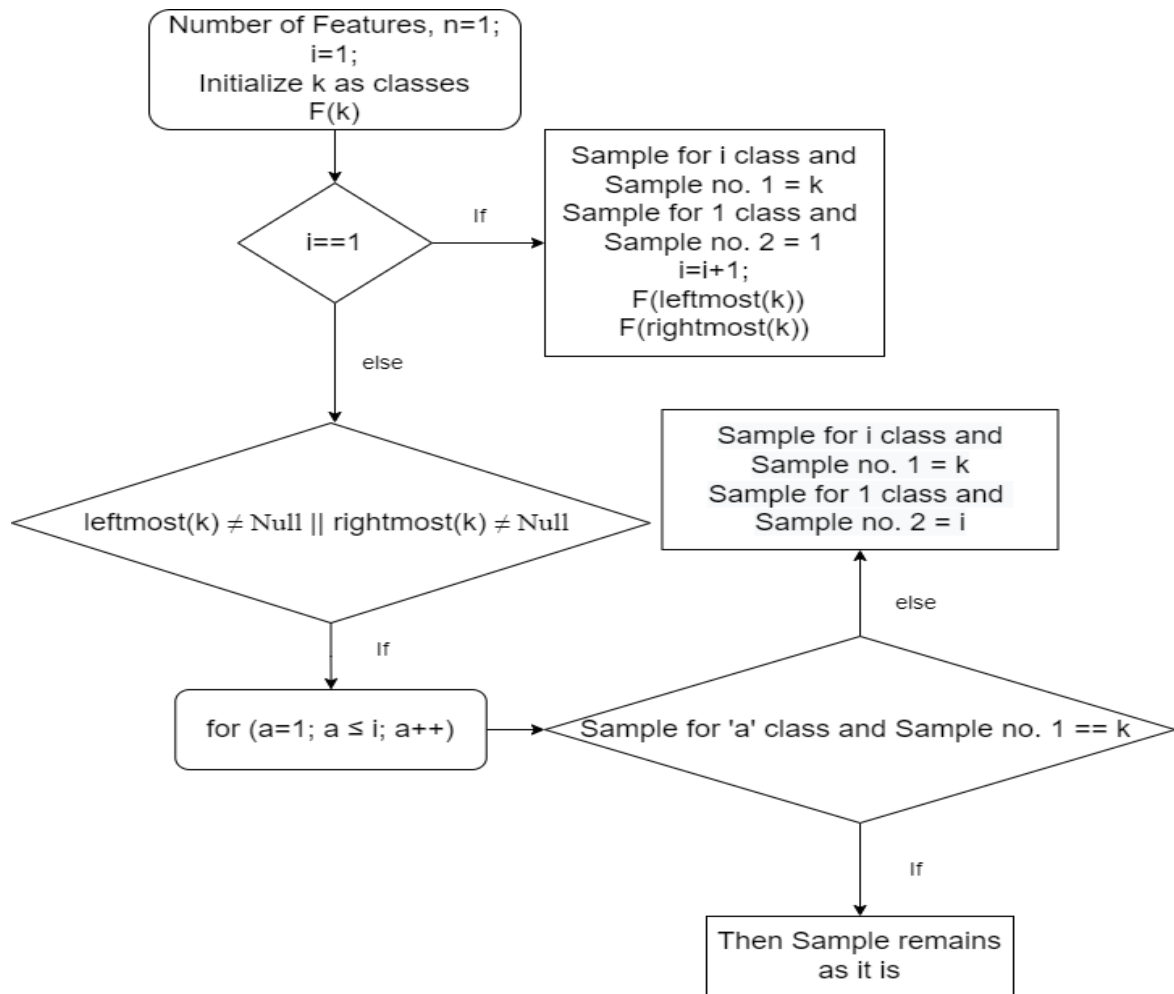

Figure 4.2: Assigning Weights [17]

Output:

[[0.78723404 0.41076294]
[0.38297872 0.40735695]
[0.08510638 0.03814714]
[0.53191489 0.4359673]
[0.34042553 0.70504087]
[0.31914894 0.54223433]
[0.63829787 0.44277929]
[0.23404255 0.03950954]
[0.14893617 0.02588556]
[0.82978723 1.]
[0.57446809 0.40463215]
[0.72340426 0.01634877]
[0.93617021 0.09400545]
[0.10638298 0.41008174]
[0.87234043 0.4400545]
[0.0212766 0.0013624]
[0.74468085 0.13828338]
[0.04255319 0.]
[0.46808511 0.42166213]
[0.70212766 0.02929155]
[0.36170213 0.40258856]
[0.55319149 0.376703]
[0.29787234 0.6253406]
[0.61702128 0.36852861]
[0.42553191 0.46934605]
[0.68085106 0.03542234]
[1. 0.42506812]

[0.85106383 0.47888283]
[0.21276596 0.0013624]
[0.40425532 0.39713896]
[0.44680851 0.47138965]
[0. 0.00817439]
[0.17021277 0.02724796]
[0.06382979 0.]
[0.5106383 0.373297]
[0.89361702 0.3739782]
[0.45865497 0.43222927]
[0.42544516 0.45618156]
[0.42906118 0.35794254]
[0.48844809 0.42258858]
[0.26787986 0.41525228]
[0.20837812 0.11400864]
[0.52749673 0.5063802]
[0.11706232 0.41042366]
[0.4605057 0.4301554]
[0.59644886 0.37020269]
[0.60115572 0.37418871]
[0.43659664 0.44715381]
[0.65321226 0.42284754]
[0.42977482 0.52319696]
[0.5149772 0.4049332]
[0.3623621 0.24903402]
[0.32510652 0.53815249]
[0.62264809 0.42869426]
[0.43220067 0.46187322]
[0.43847781 0.45483924]]

0 0
1 0
2 0
3 0
4 0
5 1
6 0
7 1
8 0
9 0
10 0
11 0
12 0
13 1
14 1
15 0
16 0
17 0
18 1
19 0
20 0
21 0
22 0
23 1
24 1
25 0
26 1
27 0
28 0

29 0
30 0
31 0
32 0
33 0
34 0
35 0
36 1
37 1
38 1
39 1
40 1
41 1
42 1
43 1
44 1
45 1
46 1
47 1
48 1
49 1
50 1
51 1
52 1
53 1
54 1
55 1

Confusion Matrix and Classification Report:

[[99150 249]

[4665 10192]]

	precision	recall	f1-score	support
0	0.91	1.00	0.98	99700
1	0.97	0.73	0.84	15357
accuracy			0.96	115057
macro avg	0.97	0.86	0.91	115057
weighted avg	0.96	0.96	0.96	115057

Design 2: Pilferage detection through Raspberry Pi module

In Design 2 we used Oversampling Method (SMOTE) and Bagging method on the previous dataset. For bagging method, we used RF (Random Forest) to train the model.

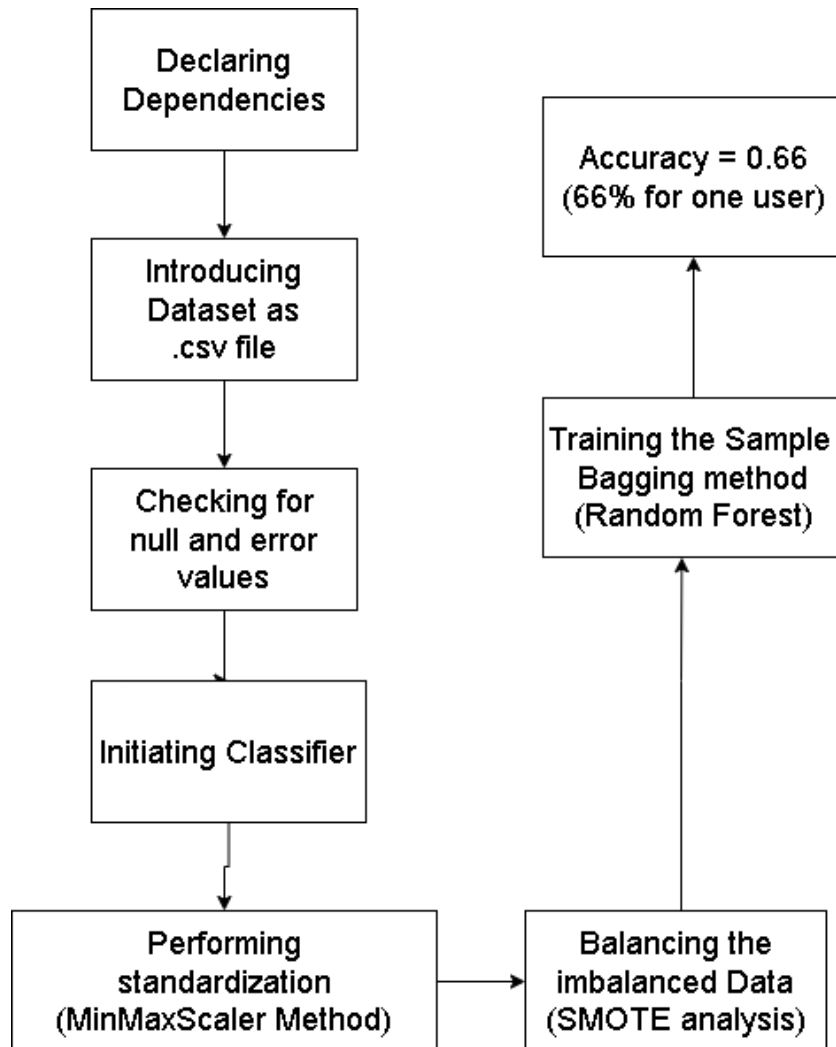

Figure 4.3: Workflow of the ML Algorithm

Output:

```
ray([[8, 2],  
     [2, 0]])  
Overall Accuracy: 0.6666666666666666
```

4.3 Identify optimal design approach

After optimizing our ML, we can initially decide which criteria by whom we will select a suitable design for our final result. Here is a table depicting the findings of all the designs:

Table 4.1: Theoretical Optimal Design Selection

Criteria	Multiple Designs	
Comparison based upon	Design 1	Design 2
Complexity	Relatively lower as Raspberry is not included	Proper Knowledge required to operate the Raspberry pi
Detection Accuracy	0.96	0.66
Usage of Components	Lower number of components being used	Higher number of components being used
User Comfortability and Level of Interaction	The pilferage check needs manual authorization to check for any power discrepancy	Automated process in detecting pilferage
Control	Manual Control	Automated
Cost-Effective Analysis	Cost is lower	Cost is higher

Usability:

Within the scope of our project, the equipment that makes up the power theft detection system is designed to be user-friendly for anyone who has access to utilize it. Due to the fact that this pertains to the data of distribution and consumption, the device can only be used by those in positions of authority who have been granted authorization to do so. Additionally, those that have access to use are able to contribute more to the development of the system by utilizing additional datasets. Our equipment is able to display a wide variety of aberrant actions in their respective categories.

Manufacturability:

It is possible to manufacture this device according to the requirements. This device's individual parts are all accessible for purchase, and the whole thing is not hard to come by. Because we created a custom module based on this concept, achieving the desired level of efficiency can be challenging. In this instance, we utilized a machine learning system by selecting the appropriate method to assure the highest possible level of precision. In the event that the system for the detection of theft is installed in the distributor line, high current and voltage will be involved in this process. This presents a potential safety issue while also maximizing the system's level of efficiency.

Impact:

We intend to develop an easy-to-implement solution for the general public and to create a large user network for maximum theft monitoring. In addition to analyzing various power pilferage approaches for future enhancement, we will implement a machine-learning Deep forest algorithm using bagging techniques that utilize previously developed power pilferage models.

It is possible that power theft does not harm every person in the country, but the consequences of this misuse will be long-lasting. If its expansion is not stopped in this decade, it will soon spiral out of control. Consequently, the power economy will decline, resulting in unjust costs for electricity consumption. We came along to learn many perspectives regarding these impacts, such as,

- Economic Impact
- Environmental Impact
- Social Impact, and
- Safety and Health Impact

4.4 Performance evaluation of developed solution

The Design 1 consists of a server where the GSM module will send the data and data will be stored accordingly. we can find this server at <http://localhost:3000> if the server is maintained by a working desktop PC (Personal Computer).

Now that our server is created, we need to design the database in our server so that the data incoming can stay at the right place at the right time. We will use MySQL for the database creation.

Now that we have a working server with each input one row will be updated for time and power consumption for that time.

Now, we will use our DT constructed code on the collected data and get an output similar to the previous iteration of our results.

Output after applying the DT to the collected data:

[[0.78723404 0.41076294]
[0.38297872 0.40735695]
[0.08510638 0.03814714]
[0.53191489 0.4359673]
[0.34042553 0.70504087]
[0.31914894 0.54223433]
[0.63829787 0.44277929]
[0.23404255 0.03950954]
[0.14893617 0.02588556]
[0.82978723 1.]
[0.57446809 0.40463215]
[0.72340426 0.01634877]
[0.93617021 0.09400545]
[0.10638298 0.41008174]
[0.87234043 0.4400545]
[0.0212766 0.0013624]
[0.74468085 0.13828338]
[0.04255319 0.]
[0.46808511 0.42166213]
[0.70212766 0.02929155]
[0.36170213 0.40258856]
[0.55319149 0.376703]

[0.29787234 0.6253406]
[0.61702128 0.36852861]
[0.42553191 0.46934605]
[0.68085106 0.03542234]
[1. 0.42506812]
[0.85106383 0.47888283]
[0.21276596 0.0013624]
[0.40425532 0.39713896]
[0.44680851 0.47138965]
[0. 0.00817439]
[0.17021277 0.02724796]
[0.06382979 0.]
[0.5106383 0.373297]
[0.89361702 0.3739782]
[0.45865497 0.43222927]
[0.42544516 0.45618156]
[0.42906118 0.35794254]
[0.48844809 0.42258858]
[0.26787986 0.41525228]
[0.20837812 0.11400864]
[0.52749673 0.5063802]
[0.11706232 0.41042366]
[0.4605057 0.4301554]
[0.59644886 0.37020269]
[0.60115572 0.37418871]
[0.43659664 0.44715381]
[0.65321226 0.42284754]
[0.42977482 0.52319696]
[0.5149772 0.4049332]

[0.3623621 0.24903402]
[0.32510652 0.53815249]
[0.62264809 0.42869426]
[0.43220067 0.46187322]
[0.43847781 0.45483924]]

0 0
1 0
2 0
3 0
4 0
5 1
6 0
7 1
8 0
9 0
10 0
11 0
12 0
13 1
14 1
15 0
16 0
17 0
18 1
19 0
20 0
21 0
22 0
23 1

24 1
25 0
26 1
27 0
28 0
29 0
30 0
31 0
32 0
33 0
34 0
35 0
36 1
37 1
38 1
39 1
40 1
41 1
42 1
43 1
44 1
45 1
46 1
47 1
48 1
49 1
50 1
51 1
52 1

53 1

54 1

55 1

4.5 Conclusion

As a summary, the first approach is more efficient, affordable and expandable in comparison with our second design which shows significant higher accuracy. So, we have chosen the first design as the optimal design.

Chapter 5: Completion of Final Design and Validation.

5.1 Introduction

Our project's construction is completed when we get to EEE400C. It required a number of evaluations, permissions, and an extensive procedure to determine the budget before the project could be finished. Following a number of investigations, we settled on a specific layout that has been effectively put into action and is now operating without incident. We are able to locate the essential components, workshops, and testing lab thanks to the advice provided by our assigned ATC as well as other specialists. We also run into certain challenges when trying to choose acceptable components and designs with high degrees of precision.

5.2 Completion of Final Design

Final Hardware Design Completion:

In an attempt to limit the amount of money spent on electricity, the goal of this initiative is to audit any power taken in before the energy meter, which is considered power theft. By sending an SMS to the necessary authorities, the energy meter will be identified. A current sensor measures the difference between input and output power in the presence of a tolerance and bypass load. Also included is an Optocoupler PC817 for detecting pulses.

Multiple loads were linked prior to the energy meter to represent a specific area, while the bypass line was also connected. When the bypass line is active, the Micro-Controller of the energy meter begins to monitor fluctuations in the power supply to the actual load. On the LCD, an alert indicating the power theft is shown as Status: Abnormal immediately. In addition, the Micro-Controller, through the SIM800L, sends the report as an SMS to the two users' cell numbers that were previously registered on the Microcontroller.

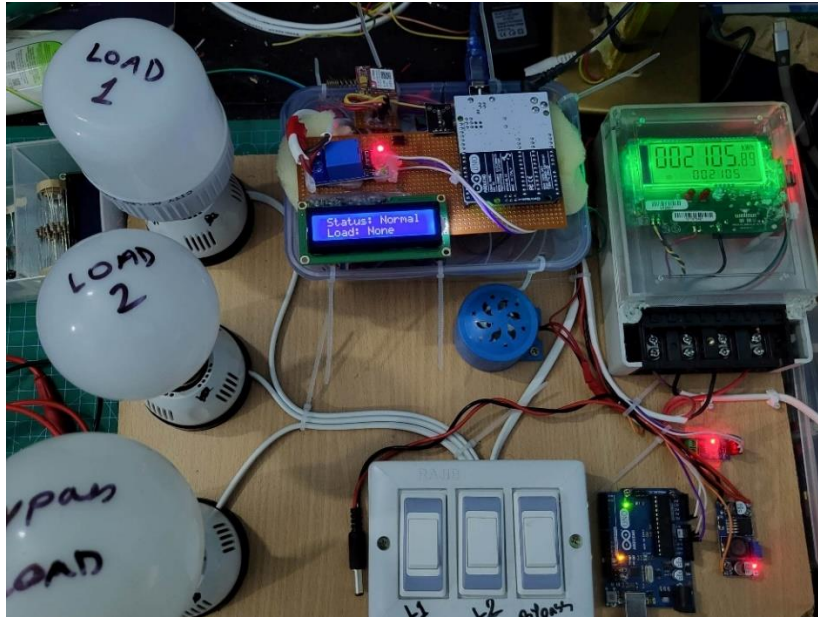

Figure 5.1: Hardware Components of the project that will be used to capture Current and other required data.

Final Machine Learning System Completion:

We used DT algorithm constructed via C 4.5 algorithm. [21] The attributes we used are Number of appliances, Numbers of persons, Temperature, and Season. The number of appliances usually went 4 to maximum 16. Regarding the number of persons, we considered average 4 persons per household. Temperature and Season was attributed from the yearly weather database of the location. [19] [20] The sample data was taken from a dataset for various homes in USA across one year.

```

[14] 1 import numpy as np
      2 import matplotlib.pyplot as plt
      3 import pandas as pd
      4 from sklearn.tree import DecisionTreeClassifier
      5 from matplotlib.colors import ListedColormap
      6 from sklearn.metrics import confusion_matrix
      7 from sklearn.model_selection import train_test_split
      8 from sklearn.preprocessing import StandardScaler
      9 from sklearn.metrics import accuracy_score
     10 from sklearn.metrics import classification_report, confusion_matrix

[7]  1 data_set= pd.read_csv('House_data01.csv')
     2 x= data_set.iloc[:, [2,3]].values
     3 y= data_set.iloc[:, 4].values

[9]  1 x_train, x_test, y_train, y_test= train_test_split(x, y, test_size= 0.25, random_state=0)
     2 st_x= StandardScaler()
     3 x_train= st_x.fit_transform(x_train)
     4 x_test= st_x.transform(x_test)

1  1 classifier= DecisionTreeClassifier(criterion='entropy', random_state=0)
   2 classifier.fit(x_train, y_train)
   3 cm= confusion_matrix(y_test, y_pred)
  
```

Figure 5.2: DT Algorithm - 1

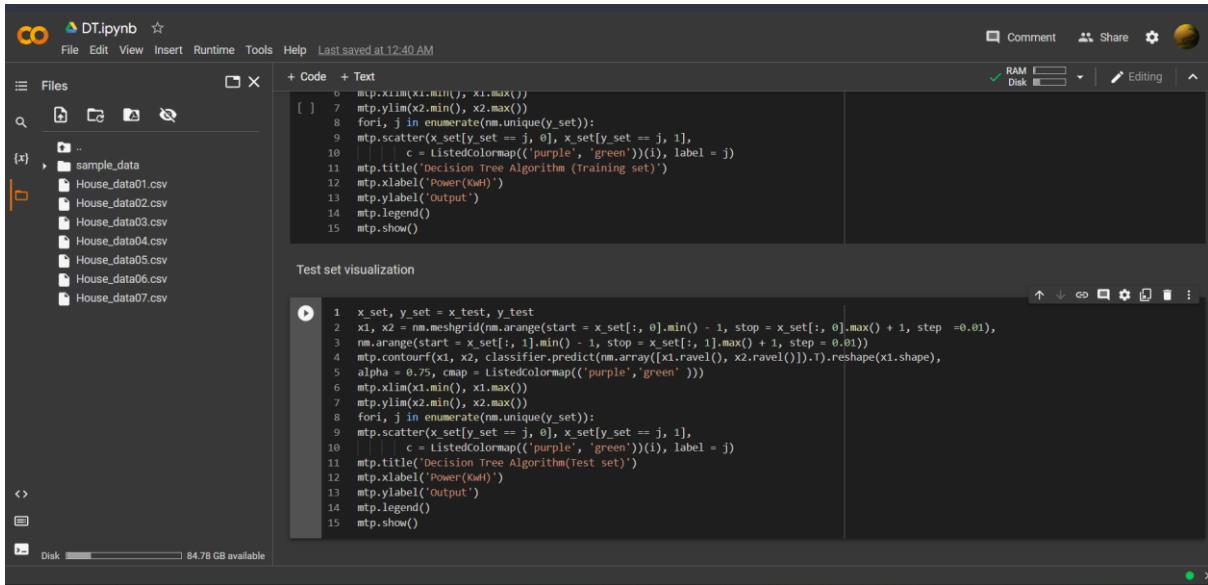

Figure 5.3: DT Algorithm - 2

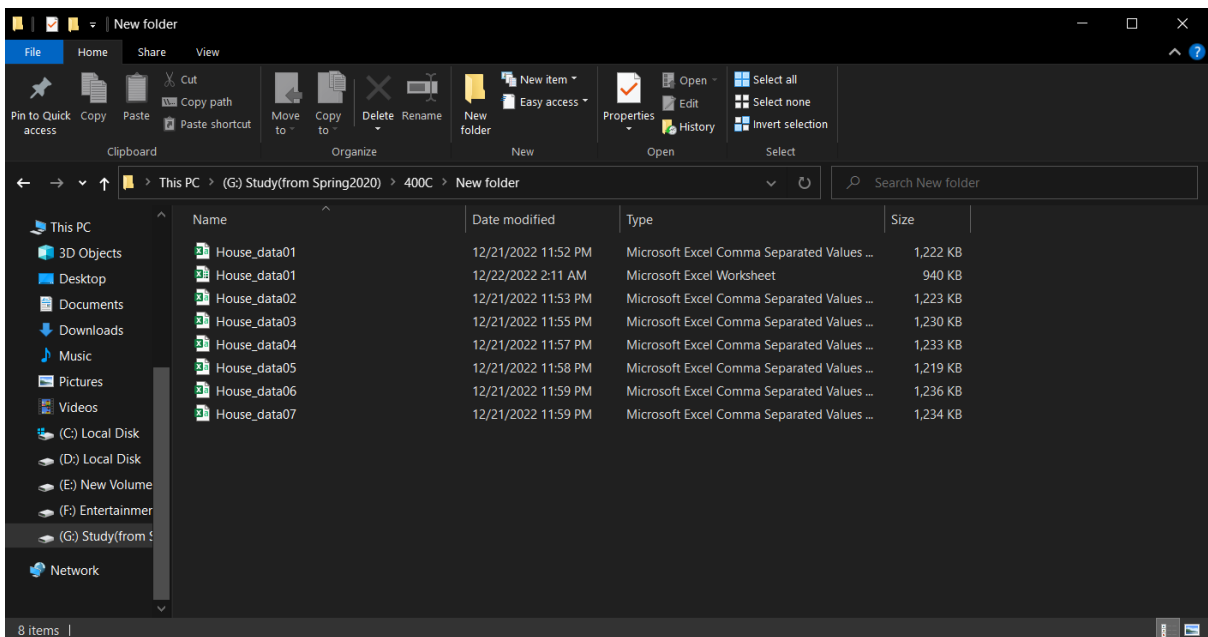

Figure 5.3: Sample data [18]

5.3 Evaluate the solution to meet desired need

During our development phase from 400P to 400C, we have faced many obstacles both functional and non-functional ways. Here is an in-depth summary of all the hurdles and how we overcame them.

Fully Functional: Our final design is capable of detecting both short term and long-term effects of illegal power consumption. The short-term effects include, real-time Pilferage Detection and

Meter Temper Prevention. The long-term effects include line bypassing, line tempering etc. Our system provides the long-term facilities by using our intricately made ML algorithm.

Cost Effective: We used Arduino over Raspberry pie-4 and also personal computer to match all the required attributes. We also choose to complete our wiring via soldering to tackle any kind of miscellaneous errors. These attempts made our system more cost effective.

Mid-level or Higher Efficiency: As discussed before, the algorithm we developed is still in an initial phase. One of the cons for DT is its higher complexity and fitting inaccuracy. But due to DT having the most accuracy the cons are dissipated. Again, the cons are rather concerning, so, we will consider a Mid-level efficiency for our final design.

Real Time data reading: This device is capable to take real-time data from the user's side. GSM 800L module sends the data to a central server where data is classified and stored for our ML approach.

Power Consumption: The Arduino Uno R3 consumes 2.86mA current on 5V. The GSM module uses 12.5mA hour per day on 3V. We can assume, +/- 0.1watt excess power which will not be considered unauthorized.

5.4 Conclusion

In order to bring this chapter to a close, we can claim that our ideal design is efficient in terms of supplying the outcomes and that there are items on the market that are both cost-effective and accessible. Our product will provide the precise precision that our customers are looking for, which will be a factor that will make them happy. In addition, if an unauthorized person makes any attempt to use the meter in an unethical way, our customers will be notified as quickly as possible by the safety management alert system. After going through a significant number of iterations of trial and error, we discovered that our solution adequately meets the purpose of our project. giving us the appropriate value with which to detect power theft.

Chapter 6: Impact Analysis and Project Sustainability.

6.1 Introduction:

Power pilferage activity is a criminal offense and its losses a huge amount of power which is used unethically. Because of this illegal activity, economical loss happens as well as it increases power consumption to an average demand value that exceeds the transformer nominal power and for that, it can decrease the power quality. [22] In our project, we proposed a power pilferage system that can detect power pilferage by comparing the meter reading and the distribution unit through machine learning. The pilferage will be detected by the machine learning process. So, there is a possibility to detect the threat with more accuracy. Implementing this device can bring some impacts on power quality, economy, safety, environment, and so on. Power pilferage may affect deeply in any country if the activity goes beyond its limit.

6.2 Assess the impact of solution:

Economic impact: First of all, huge amounts of financial losses can cause by power pilferage. By this time, there is a huge amount of power loss for that. Energy mismatching problems can be created by differentiating the amount of generation and demand and a huge amount of penalty factor can impose on the power system. Active and reactive power loss will be and maintenance will be costlier. Few power pilferages indicate more power pilferage in the future and it can directly hit on the economy of the country. Power system planning, design, and installation can be costlier as well as fuel costs. After that blackouts and load shedding can be frequent which cause a great impact on our economy. In our project, proper power pilferage identification and theft detection can be made. So, power pilferage can be reduced by implementing this device in the home and distributor pole. Large-scale industries can be focused more by getting enough power. By properly implementing the power pilferage device, there will be a huge economic impact on any country. Proper power demand can be fulfilled and power loss can be brought in to imit.

Environmental impact:

By power pilferage, some people try to steal power. For that more electricity power losses and more electricity power generation needed. For more electricity power generation, more coal and fuel will be burned. For that reason, environment can be harmed by some toxic gases and global warming can increase. So, less electricity power generation need for clean the environment as much as possible. In 2016, the public and private sectors combined to generate 15351 MW of electricity in Dhaka, with a peak demand of 9036 MW on June 30, 2016, an increase of 800 MW over the previous year. [24] And carbon footprint due to generation of power will be eventually lower. So that it reduces the generation of harmful gases which can damage the environment. Also clumped up wireless network might be harmful for the economy in the long run.

Social impact:

Power pilferage is a common phenomenon of our country. If the power pilferage continuously happens again and again that can impact on society. Then people will not aware of this illegal activity. Already government set some rules against the power pilferage but without implementing the proper device people cannot be properly aware. A recent report says that, BPDB generated 14,150 MkWh of electricity and purchased another 450 MkWh from private sources but BPDB billed for only 11,462 MkWh and showing a system loss of 22%. [23] So if there can implement a proper system then the power which are stolen by some people can be investigable. So, by implementing the device people can aware of this power pilferage.

Safety and health impact:

Many occurrences can happen by working on the method of stealing electricity. Accident that happens due to power pilferage are not rare. Every day some news came up about the meter bypassing or tempering. For that, some people do many mistakes by reconnecting the wire. Bypassing the transmission wire is one of them. On the other hand, this type of works is full of risks. People can be hurt or there can be fire hazards also. Though the rate of physical accident of electric wire are reduce but the power pilferage technique is introduced day by day. So, if the proper implementation of power pilferage devices is possible then there is no chance of this kind of accidents.

SWOT Analysis:

Part	Helpful	Harmful
Internal	Strengths: <ol style="list-style-type: none">1. Proper identification of electricity pilferage.2. Identify when someone tries to meter tampering.	Weakness: <ol style="list-style-type: none">1. Device cannot work properly if the water came into the device as the device is not waterproof.2. Proper maintenance is needed if the device is okay or not.
External	Opportunities: <ol style="list-style-type: none">1. Power pilferage rate can be reduced and losses are also reduced.2. Electricity generation can be reduced so that environmental harm is also reduced.	Threats: <ol style="list-style-type: none">1. Device can be stolen and damaged.2. Data can be misplaced so there has to be security for data.

6.3 Evaluation of the sustainability

The capacity to be maintained at a favorable rate or level is known as sustainability. A product must be created and/or used in a way that does not encourage harm or destruction in order to be deemed sustainable. If a product's production demands nonrenewable resources, damages the environment, or causes harm to people or society, it is unlikely to be regarded as environmentally sustainable.

- Our product does not require any nonrenewable resource for example any kind of natural gas or any kind of fossil fuels.
- We used deep machine learning to build our product which does not require any natural resources that can be impactful to nature.

- To control the meter tempering we used some devices that are sustainable and lower in cost as well.
- Our product's main object is to stop power Pilferage which will be socially and economically more impactful.

Economical Sustainability

Economic sustainability considers both the direct and indirect financial costs and benefits. Were we look forward to make our product budget friendly as well as most effective. Basically, it is a sort of comparative analysis of the cost and what are we getting out from this system. Our main motive is to reduce power waste which is used by illegally. If our system is placed the desirable place, this system can save a lot of electricity in our country which make our project more economically sustainable. According to the report of Nesbit (2000), electricity was stolen between 1 dollar to 10 billion Dollar in US. [26]

- **Cost and performance analysis:**
There are so many research and system available in the market that can be compared to our product. Some of them are the most cost and effective or less cost less effective for example according to our research Programmable Logic Controller (PLC) power monitoring system cost higher than our product. Where our product provides our consumers most accurate result at lower price than other system that is available. Moreover, in our product small products are used in terms of any issue the repairing cost will be lower.
- **Repair and maintenance:**
As electrical devices can be damaged or may get fused so we build our product as the problem can be identified easily and can get replaced or repaired. Moreover, product parts are cost-effective and available in our market.
- **Innovative approach:**
As there so much research is still going on power pilferage and our product is designed accordingly to that so changes can be n made for more efficiency. While building our project we come up with a new idea that if any unethical person tries to open the meter there will be a buzzer that will start making sound.

Social Sustainability

The cumulative effect of factors such as community development, social support, social responsibility, cultural competence, community resilience, and human adaptation, as well as the impact of any specific machinery or cutting-edge ideas or technologies that will improve people's quality of life, is what is meant by social sustainability. Our project can increase social awareness by detecting power pilferage. People can be aware by knowing that the device made on our project can detect the power which is illegally used by the wrong people. That brings the changes between customers and employees more responsible to use and check pilferage and make the recovery as soon as possible by reducing non-technical losses. [25]

- **Social awareness and community development:**

After research, we found that the total consumption of electrical energy in Bangladesh is 53.65 billion kWh per year, and the total production of all-electric energy-producing facilities is 61 billion kWh [1]. Our main motive is to make people aware of electricity consumption and where the rest of the electrical energy goes! All consumers should have an idea of their electricity uses. Our product will bring awareness to the consumer and let the community know about our user-friendly device.

- **Community-based feedback:**

Our product is community-based. According to consumer feedback, the product can be modified and give them a user-friendly experience. The adaptation of humans can make our country fewer losses in energy consumption.

- **Environmental-sustainability:**

Our products do not emit any gas or fossil fuels, any toxic chemicals in the environment. These products are recyclable. In our project, we will use highly sensitive and flexible sensors that can be manufactured with minimum environment footprint. And our system does not leave any wastage which can involve to effect environment badly. Green products are energy efficient, durable and recycled materials from renewable and sustainable sources. [4]

6.4 Conclusion:

This chapter acknowledges the key impact and sustainability of power pilferage. Impact in economical consideration where the huge amount of losses occurs which effecting the consumers as well as the yearly counting. However, our product provides us the sustainability economically as well as socially where people are getting more aware of their usage in terms of electricity. After incorporating all the surveys and analysis Power Pilferage Monitoring and Identification System is a sustainable product for future aspects.

Chapter 7: Engineering Project Management.

7.1 Introduction:

In our project, we first started to make a tentative plan in a way that we changed the plan according to the situation appropriately. And we have divided our project into some parts and allocated time among us to complete the individual tasks. We have started our project on January 2022 and planned to conclude our work in the project by end of the November 2022. Any project could have a contingency adjustment. We also manage the adjustment to complete the task as planned by exceeding the days. We have faced some problems to manage this project like system failure, data collection, components replacement and any unwanted obstacle.

7.2 Define, plan and manage engineering project:

As we complete our project by three separate courses 400P, 400D and 400C, we have designed our project plan according to the works in each semester. First, we have tried to get enough knowledge about our project and make a tentative plan how we can design our system. Initially in 400P, we have made a project plan which are not fully carried out to construct our project. But after this course in 400D, we have made a new project plan to simulate our design. During this process we faced different types of problem and we have taken consultancies to our ATC panel and other experts. After proper implementation of software, we have completed our simulation design by August 2022. After 400D, we made another project plant for 400C. We had to need real data for run the system through machine learning. But due to difficulties to getting real data, fund and several factors, some delay was happened to complete our task as project plan. But we were able to complete our system as planned time and we have completed our whole process by the end of November 2022.

Table 7.1: Project Plan Time frame of EEE400-P EEE400-D and EEE400-C

Time Frame	Task	Start Date	Days to Complete
EEE400P	Project Selection	10-02-2022	5
	Concept note	24-02-2022	14
	Final Proposal & Component Selection	10-03-2022	15
	Tools Selection & Component Finalization	15-03-2022	5
	Draft Design	25-03-2022	10
	Multiple Design Approach	31-03-2022	7
	Final Project Design	07-04-2022	15
EEE400D	Multiple Design Approach Simulation	26-05-2022	15
	Collection Data	31-05-2022	4
	Updates From Data	09-06-2022	10
	Trying all Multiple Design Approaches	16-06-2022	7
	Collecting and comparing	21-07-2022	20
	Final Report	10-08-2022	9
EEE400C	Component Collection	21-09-2022	12
	Implementing Design	28-09-2022	7
	Testing	4-10-2022	20
	Data Collection	11-10-2022	7
	Updating Implementing Design	18-10-2022	7
	Necessary Upgrade	25-10-2022	6
	Final Data Collection & Comparison	9-11-2022	14
	Draft Report	20-11-2022	11
	Final Report	22-11-2022	2

Gantt. Chart:

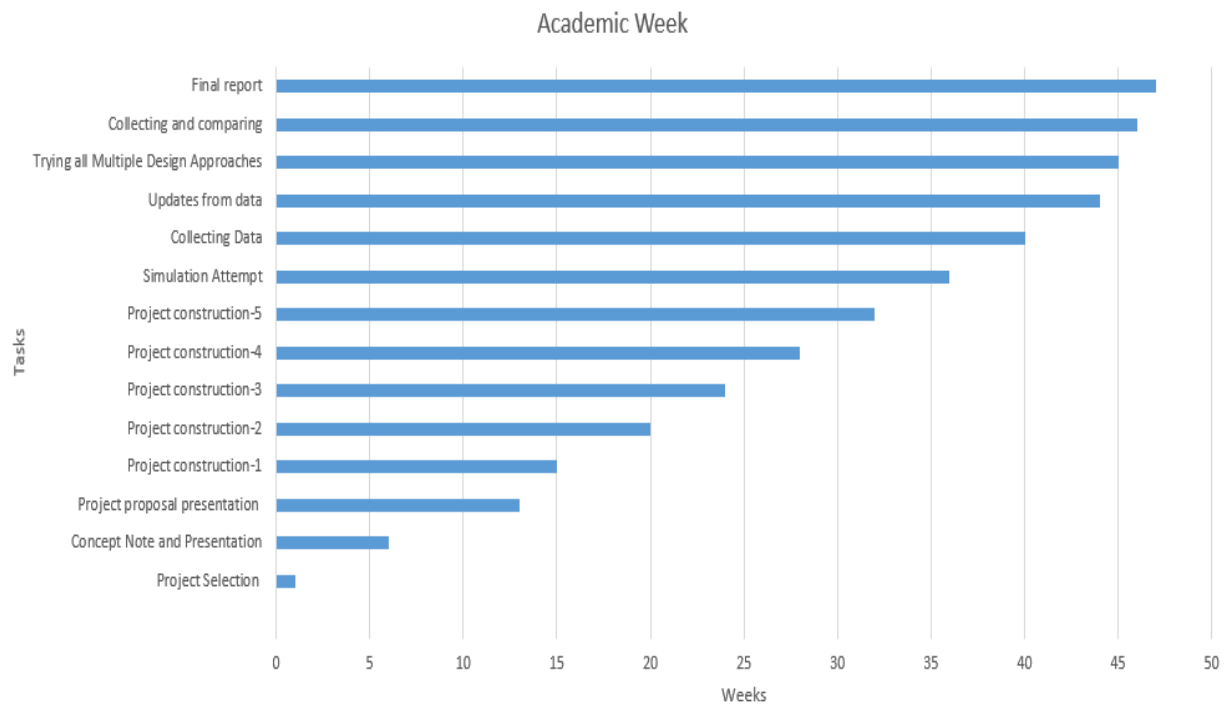

Figure 7.1: Gantt Chart

7.3 Evaluate project progress:

The process of selecting the proper component for our design has presented us with several challenges. Some of the components were purchased from internet sites, while others were purchased from various brick-and-mortar electrical supply stores. After we had gathered all of the necessary components, we needed a suitable laboratory in which to put those components together and do the necessary measurements of current and voltage. After we had finished the correct installation of all of the components, we ran into some problems, but we were able to find a solution within the allotted amount of time according to the project plan. After finishing every step of the hardware implementation process, we put the system through its paces to test whether or not the theft detection features are functioning as expected. In addition, the construction of our hardware was finished by the end of November 2022.

Following the conclusion of the design phase, we have begun to prepare for giving our theft apparatus a concrete form. We put our system through a number of tests to gauge how well it can identify instances of theft. Everyone in our organization participates in running the simulation and ensuring that it is accurate in every way. We maintained communication with our assigned ATC by email and provided information as it was necessary.

7.4 Conclusion:

In the end, we were able to finish our project despite having various limitations. As part of our project, we created a gadget that is able to identify instances of power or energy theft. And it cuts down on unlawful activity like tampering with the meters and going around the line, among other things. Therefore, more work will be necessary in order to improve the accuracy of this system. In addition to this, more time will be required in order to achieve the ideal physical body form for this gadget. In order for it to be feasible for implementation in each individual home and distribution pole.

Chapter 8: Economical Analysis.

8.1 Introduction

The Desktop Computer is the most expensive component in this instance. For the purpose of data collection, a desktop computer is an absolutely necessary piece of equipment. All of the costs of the necessary components are broken down here in a clear and concise manner. The list now includes two additional microcontrollers in case there are any unexpected roadblocks in the near future. The list that has been suggested is able to carry out practically all of the design that has been explored. Last but not least, another component titled "miscellaneous cost" has been introduced in order to prepare for any unavoidable circumstances that may arise in relation to the budget issue.

8.2 Economic analysis

We tried to research the costs of products sold at all available offline and online retailers in order to get the best deals. After completing all of the steps involved in the survey, we came to a final conclusion regarding the purchase. For instance, given that we required two Arduino Uno Microcontroller boards, the prices that were being asked for in the neighborhood stores amounted to taka 1,100. On the other side, the item was showing up at taka 12,79 in the online store of Daraz, but it was only taka 1050 in the online store of Roboticsbd, therefore we decided to go with Roboticsbd.

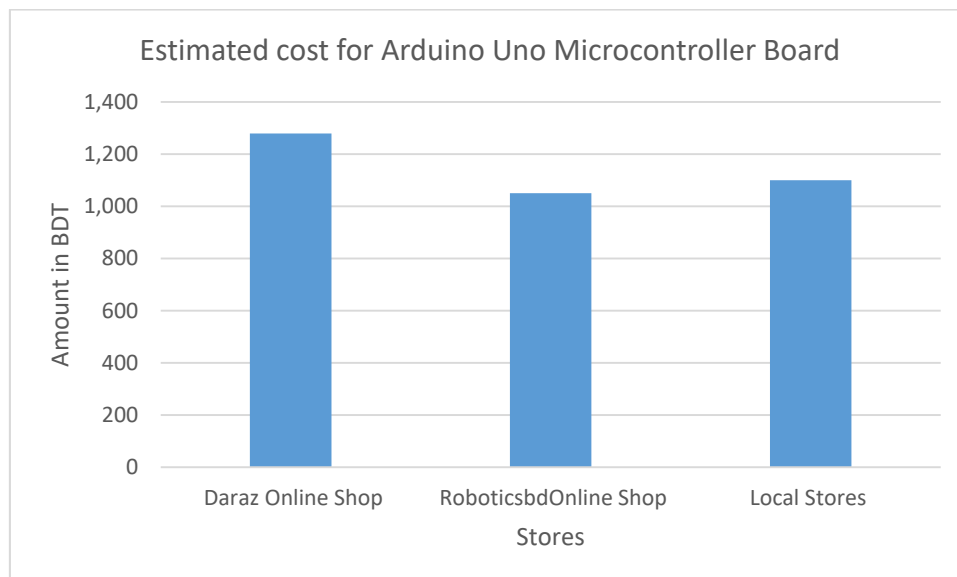

Figure 8.1: Arduino Uno Microcontroller Board Price at Daraz Online Shop, Roboticsbd Online Shop and Local Shops

The difference between our anticipated budget and our actual budget will now be discussed. Because of ongoing issues on a worldwide scale, most of the costs went up.

Table 8.1: Initial Budget Plan

<i>Components</i>	<i>Uni Price</i>	<i>Quantity</i>	<i>Total cost (BDT)</i>	<i>Source</i>
Energy meter	1500	2	3000	Local shop
Arduino Uno (R3)	939	2	1878	roboticsbd.com
LCD display (16x2)	250	2	500	roboticsbd.com
SIM900L	1500	2	3000	www.makersbd.com
Male pin header	20	2	40	roboticsbd.com
Microcontroller (ATMEGA328p)	440	2	880	roboticsbd.com
Current Sensing module (ACS712)	220	2	440	roboticsbd.com
Diode and Resistors	200	2	400	www.makersbd.com
Vero board	25	2	50	roboticsbd.com
Wire (2 meter)	20	2 meters	40	Local shop
Switches	40	2	80	Local shop
LED Bulb	250	2	500	Local shop
Desktop Computer	15,000	1	15,000	ryanscomputers.com
Device box (Acrylic sheet)	1000	1	1000	roboticsbd.com
Infrared Sensor (PIR)	100	1	100	roboticsbd.com
Arduino MKR1000 board	300	1	300	roboticsbd.com
Solid State Relay (40A 100V DC)	100	1	100	roboticsbd.com
Integrated Voltage Regulators (LM7805)	250	1	250	roboticsbd.com
Software developing	-	-	5000	-
Subtotal			32,058	-
Miscellaneous cost			1500	
Final budget			33,558	

Table 8.2: Final Budget

<i>Components</i>	<i>Uni Price</i>	<i>Quantity</i>	<i>Total cost (BDT)</i>	<i>Source</i>
Energy meter	1500	1	1500	Local shop
Arduino Uno (R3)	1050	2	2100	Roboticsbd.com
LCD display (16x2)	250	2	500	Roboticsbd.com
SIM900L	450	2	900	Roboticsbd.com
Male pin header	20	2	40	Roboticsbd.com
Microcontroller (ATMEGA328p)	440	2	880	Roboticsbd.com
Current Sensing module (ACS712)	250	1	250	Roboticsbd.com
Diode and Resistors	200	-	200	Roboticsbd.com
5V, 2A DC Adapter	250	1	250	Local Shop
Vero board	50	2	100	Roboticsbd.com
Wires (AC)	15	5 Yards	75	Local shop
Wires (DC)	10	2 Yards	20	Roboticsbd.com
Switches	40	3	120	Local shop
Holder	35	3	105	Local shop
AC Plug	25	1	25	Local Shop
LED Bulb	250	3	750	Local shop
Desktop Computer	15,000	1	15,000	Ryanscomputers.com
Device board	100	1	100	Roboticsbd.com
Mechanical Limit Switch	150	1	150	Daraz.com
1 Channel 5v Relay	120	1	150	Daraz.com
Buzzer	50+100	2	150	Roboticsbd.com
DC to Dc Buck (LM2596)	100	1	100	Roboticsbd.com
Soldering and Glue gun cost	200	-	200	Local Shop
Software developing	-	-	5000	-
Subtotal			28,665	-
Miscellaneous cost			1000	
Final budget			29,665	

Our anticipated budget was Taka 33,558 based on the components alone, and the budget for the finished project is within the range of Taka 29,665 or thereabouts. In this case, the difference amounts to just around Taka 3,893.

8.3 Cost benefit analysis

It would seem that if we tried to execute our whole concept in a single PCB, this is something that is both conceivable and sustainable. But the primary concern was the additional financial burden it would have on us. We contacted local retailers to find out if it was feasible or not, but we discovered that the quality wasn't up to the level. Later, we came across more international vendors such as JLC PCB, which manufactures high-quality PCBs in lower cost. Because our technology is merely a prototype, it can detect and capture data up to 30A, but it won't be of much use for future results because of this limitation. So, we moved with the Vero board and soldering.

In the end, we decided that Arduino would be more cost-effective than Raspberry pie-4. In order to transform the data, we will utilize our own computer to produce a .csv file, which we will then use to compare throughout the coding process for machine learning.

Table 8.3: Comparison of Arduino Uno with Raspberry Pie-4, based on the specifications.

Equipment	Lower Range in BDT
Raspberry Pie-4.	1,3999
Arduino Uno	1,050

Here, it is clear from this that there is a difference in the price of 12,949 taka. This is a huge and the primary reason we chose Arduino Uno over Raspberry pie-4 in our comparison.

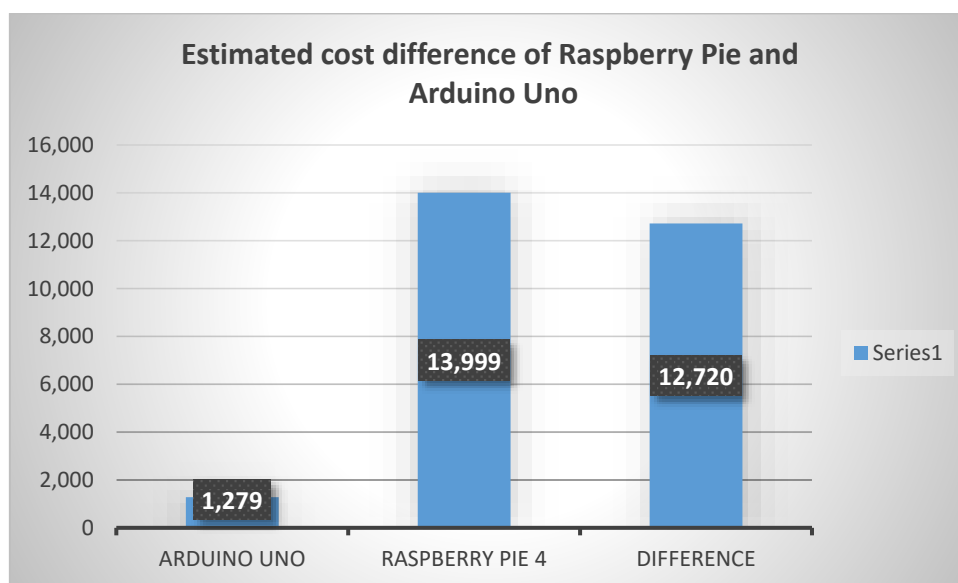

Figure 8.3: Estimated cost difference of Raspberry Pie and Arduino Uno

Table 8.4: Comparison of local and international PCBs with Vero Board, based on the specifications.

Equipment	Lower Range in Bangladesh
PCB in Bangladesh	1000
PCB in China (With delivery cost)	1200
Implementation in Vero Board	200

When compared to using a Vero board, the price of a quality printed circuit board (PCB) manufactured in China is around one thousand taka more expensive. Also, we didn't have any fundamental understanding of how to create the schematics or produce the gerber files, which was another reason why we decided to skip PCBs.

8.4 Evaluate economic and financial aspects

The previous cost evaluation makes it plainly evident that the first pricing of the development was rather costly since we were required to obtain the components in their separate forms. This was the primary cause of the increased cost of the initial pricing. Despite this, we continue to uphold a wide range of attributes while doing the highest quality job we are capable of in order to get the most advantageous outcome in terms of cost.

8.5 Conclusion

The intention was to develop an original concept with its own perspective. Our target was a public system that is simple to implement with the establishment of a vast user network for optimum theft monitoring. Moreover, to study various pilferage strategies for future enhancement and the implementation of machine learning Deep forest algorithms. For the purpose of making our price range as low as feasible in order to make it as cost-effective as possible as part of our sustainability strategy, we have had to sacrifice many different facilities and also take many difficult pathways in order to achieve the best possible rate of success.

Chapter 9: Ethics and Professional Responsibilities

9.1 Introduction

In order to fulfill people's requirements, promote economic growth, and provide for society's necessities, engineering is a crucial activity. Application of the scientific and mathematical sciences with a goal in mind is what engineering entails, along with a corpus of engineering knowledge, technology, and procedures. In frequently uncertain environments, engineering aims to create solutions with impacts that can be foreseen to the maximum extent possible. Engineering work has possible drawbacks even as it offers advantages. Therefore, engineering must be carried out responsibly and ethically, use resources effectively, be economical, protect health and safety, be ecologically responsible and sustainable, and generally manage hazards over the whole lifecycle of a system [27] There are many historical examples that might teach us about ethical failings and their effects. The infamous Tuskegee syphilis study [28] and the Nazi medical experiments [29] are two instances. The researchers' lack of ethical behavior led to these horrible tragedies. Because it is an essential component of conducting any scientific study, researchers must thus treat this aspect carefully.

9.2 Identify ethical issues and professional responsibility

To offer a positive example for aspiring researchers, one must abide by a number of ethical rules. Ethics guidelines guarantee the validity of the study and raise the spirits of collaborators and research participants.

Due to this, we have considered a variety of ethical issues in our project [30]. Here are some of them:

1) Permission from Authorities:

For optimum recognition, all research must be conducted at a facility that has received government recognition. There is an Institutional Review Board for each institution (IRB). We will also seek IRB permission from our universities. We would also seek approval from DESCO and the Power Grid Company of Bangladesh (PGCB) before implementing our proposal into the power transmission lines and grids.

2) Following Existing Guidelines:

PGCB and DESCO both have their own rules to abide by [31] [32] [33]. To ensure that our system is implemented smoothly, it is vital to adhere to those rules after receiving permission.

3) User-Agreement and Privacy Policies:

Users can access the data gathered as part of our project's mobile application. Data collection takes conducted on a server, which needs to be located in a safe area to protect privacy. All requirements for using our service must be expressly spelled out in an effective Terms and Conditions Agreement. Users must have the option to depart at any time.

4) Usage of High-Quality Materials and Equipment:

When selecting premium tools and supplies for our project, we cannot be sparing. Long-term efficiency will be improved by better materials and equipment because they will require less maintenance.

9.3 Apply ethical issues and professional responsibilities

When the pilferage detecting system is fully implemented on each distributor line, it is expected that the power pilferage will significantly be reduced. Because those who use power illegally will be in threat with getting caught by proper investigation. There has also some code of conduct which is provided guidelines for the minimum appropriate standard. Also, there have some professional responsibilities in our project. As the public, they build confidence in professional trustworthiness.

- **Report Writing, Preparing Slides:**

During the writing stage, proper references and citations were utilized to prevent any form of plagiarism. The elimination of any unprofessional terms was also a primary objective. We attempted to use sufficient figures and data tables to support our conclusions. Additionally, we checked proper punctuation and formatting.

- **Approval from Government:**

In the context of our project, the power pilferage detecting system has to be subject to a number of ethical considerations and professional obligations. A common person cannot make use of this equipment in any way. It needs to be used by the concerned government entity in order to identity theft from the distributor line all the way to the home line end.

- **Safety Measures:**

Electric conductivity and proper wiring for the prototype device:

As already mentioned, this device should be maintained very carefully and the wires cannot be short at any cost. This may lead the device to an unwanted firing situation.

Weather measure:

A contraption with plastic racks and waterproof sheets must be constructed so the device may stay safe when natural disasters happen. The device will remain dry during rain

and It will also keep the device cool during a heat wave. Most Importantly, dust and small flying debris will not damage our circuits

Proper safety guards:

As already mentioned, this device contains heavy electricity conductivity, and different safety measures were followed during the construction period. Following the diagram strictly and wearing non-conductive gloves were the first priority while working.

Avoiding unwanted situations:

For avoiding any kind of unwanted scenarios, such as theft, meter tempering, or failure of the operation, this device is capable to shut down the whole system with the help of a relay. A coded GSM module is also being used to inform the user about the situation.

9.4 Conclusion

Before, during, and after the completion of the project's execution, it is our responsibility to think about the ethical implications, safety problems, and any other possible outcomes that may occur for the individuals who are engaged. As a result of this, we have considered every ethical standard that an engineer may be expected to uphold. We think that by taking this step, we will be able to serve as an example for future scholars as well as motivate engineers to start new projects in this field

Chapter 10: Conclusion and Future Work.

10.1 Project Summary / Conclusion

Power pilferage is an extremely volatile issue for countries like ours. It is undoubtedly frustrating to see the hard-earned tax payer money not utilizing properly by government. Rather it is getting stolen by people who have no notion of doing good for the better. They leech onto the unfair means like a parasite slowly draining the lifeforce of an infrastructure. Our country is blessed with a lot of boons that others might feel jealous about, such as: our seasonal interchanges, abundance of minerals, access to usable water, better geographical location etc. Each of this are boons and we should be utilizing them for the better not destroying them. So, instead of seeking to make a quick profit by unfair means, we should instead focus on improving our country for the better.

This project's goal is to avoid immoral acts, such as energy fraud, device installation mistakes, nonpayment of customers, accounting problems, etc., from the transmission to distribution line and to ensure a sustainable clean power supply for the general public. However, our future efforts in relation to this project will entail substantial enhancements: With or without machine learning, smart meter-based power monitoring pinpoints the precise location of line tapping and bypassing. Here are the current project objectives:

- To develop a system that can recognize and quantify power theft between a supply unit and a consumer unit utilizing materials and technology that are financially accessible.
- To develop an efficient simulation method for improved management.
- An effort to save millions of dollars that goes to waste due to faulty detection processes.

10.2 Future work

The Bangladesh Power Development Board (BPDB) released its annual report on electricity production for the fiscal year 1999. Total power sector losses were reported to be 35% in that study. Twenty-two percent of the total loss was attributable to technical difficulties, while the remaining fourteen percent was the result of illegal activity on the line [4].

The most current fiscal year, 2017–2018, shows a considerable increase in all areas measured by BPDB's annual report. In 2017–18, the system as a whole lost a weighted average of 11.87% of its value. Significant progress has been made in reducing line loss, although the average technical loss still sits at 9.89%. Therefore, it is unacceptable that 1.98 percent is still attributable to illicit methods [34]. The remarkable strides our nation has made in the electricity sector need to be protected, and it is our hope that this initiative will help achieve that goal. It is our belief that a perfect implementation of our project would result in a drop of 1.98% to zero.

We want to eventually implement a completely automated system. Our goal is to optimize our system so that it works in a streamlined manner. In order to do this, we need our GSM module to upload the data to our server, transform it into a csv file on its own, and then generate the decision result automatically.

In order to safeguard our national economy, it is imperative that we put an end to this immoral situation as soon as possible. If the government assists us by letting us collect specific data that we need to operate our Machine Learning system, it is very much feasible that we could also develop our system according to that aspect. This design incorporates all of the most cutting-edge technologies and is built on the data that it collects, making it entirely adaptable to changing requirements. Additionally, this gadget may be managed by designing mobile applications also. And in addition to a lot of other security measures, this system is very much capable. This system, which is called the "Power Pilferage Detection and Identification System," has the potential to become a national treasure if the initial investment is recouped.

Chapter 11: Identification of Complex Engineering Problems and Activities.

Attributes of Complex Engineering Problems (EP)

	Attributes	Put tick (√) as appropriate	Comment
P1	Depth of knowledge required	√	In order to properly construct and interconnect all the systems and sub-systems, we went through deep machine learning for better outcome of the project as well as decent understanding in Power calculation, Arduino, C programming and Python. We also went through various research papers and literature reviews for further knowledge.
P2	Range of conflicting requirements		
P3	Depth of analysis required	√	Our problem was defined in order to combat the unauthorized usage of massive amounts of electric power which results in the country losing a lot of financial asset every year. Our project to solve this was not an obvious one as we had to go through other similar studies regarding power pilferage and its management. So, during the project constructing we faced some issues which we able to overcome those due to going through several research papers.
P4	Familiarity of issues	√	Our problem is recognized by many researchers in the world. So, this idea is frequently encountered almost in every part of the world.

P5	Extent of applicable codes	√	We have checked necessary codes and practices from IEEE, NFPA and ISO
P6	Extent of stakeholder involvement and needs	√	Power pilferage is one of the major issues in our country and most of citizen of are affect by this. As this project requires daily data collection from users, we have made a reasonable Terms and Conditions policy for better user experience. We also have considered getting permission from proper authorities, creating Investor insurances and crediting involved institutions when we get public with our project. After talking with some stakeholders, we add an alarm warning security system if any unauthorized person opens the meter for tempering.
P7	Interdependence	√	All of our systems and subsystems work simultaneously in order to generate the desired result which enough safety protocols in mind.

Attributes of Complex Engineering Activities (EA)

	Attributes	Put tick (√) as appropriate	Comment
A1	Range of resource	√	We constructed our project from the basis of 10 or more research endeavors and papers. After comparing all the multipole designs we decided to go with the machine learning. After market research and buying the materials we prepared our budget. Finally, we carefully assigned each of the group members in different tasks through a Gantt chart for maximum efficiency.
A2	Level of interaction	√	Our project includes an in-depth analysis on the impacts, sustainability, ethical consideration and risks regarding power pilferage.

A3	Innovation	√	Our system can get upgrades in workflow, algorithms, hardware and software level. Which during constructing the add some new features.
A4	Consequences for society and the environment	√	We have considered multiple societal and environmental risks and impacts in our report. We have taken the necessary steps to mitigate the issues as much as we could.
A5	Familiarity	√	Power pilferage is a worldwide problem that causes millions of dollars of damage to a country's financial environment. The effect of this damage is felt severely among developing countries such as ours. So, countless studies and researches happen in order to stop this rather unpredictable problem. Our own report is proof of that.

We have searched through a number of websites and publications to understand the complicated engineering concept, including the data analysis, component analysis, risk analysis, and risk mitigation required to build the project. As a result, a variety of sources were utilized for this intricate technical investigation.

References:

- [1] “Energy consumption in Bangladesh,” Worlddata.info, 0 0, 2018. [Online]. Available: <https://www.worlddata.info/asia/bangladesh/energy-consumption.php>. [Accessed: Apr. 28, 2022]
- [2] “Electricity pilferage - Wikipedia,” Electricity pilferage - Wikipedia, Mar. 01, 2021. [Online]. Available: https://en.wikipedia.org/wiki/Electricity_pilferage. [Accessed: Apr. 28, 2022]
- [3] S. S. Sreenadh Reddy Depuru, L. Wang, and V. Devabhaktuni, “Electricity pilferage: Overview, issues, prevention and a smart meter based approach to control pilferage - ScienceDirect,” Electricity pilferage: Overview, issues, prevention and a smart meter based approach to control pilferage - ScienceDirect, Dec. 07, 2010. [Online]. Available: [sciencedirect.com/science/article/abs/pii/S030142151000861X](https://www.sciencedirect.com/science/article/abs/pii/S030142151000861X). [Accessed: May 07, 2022]
- [4] T. B. Smith, “Electricity Pilferage: A Comparative Analysis,” sciencedirect.com, Dec. 0, 2004. [Online]. Available: <https://www.sciencedirect.com/science/article/pii/S0301421503001824>. [Accessed: May 07, 2022]
- [5] Md. Saiam, S. Md. Salimullah, Md. S. Akther, Md. Z. Islam, and T. H. Bhuiyan, “Reducing Electricity Pilferage by Low Frequency Control Scheme in Bangladesh,” Reducing Electricity Pilferage by Low Frequency Control Scheme in Bangladesh, Dec. 20, 2020. [Online]. Available: <https://ieeexplore.ieee.org/document/9350450>. [Accessed: May 07, 2022]
- [6] G. L. Prashanth and K. V. Prasad, “Wireless power meter monitoring with power pilferage detection and intimation system using GSM and Zigbee networks ,” academia.edu, Nov. 0, 2014. [Online]. Available: https://www.academia.edu/10892099/Wireless_power_meter_monitoring_with_power_pilferage_detection_and_intimation_system_using_GSM_and_Zigbee_networks?from=cover_page. [Accessed: May 07, 2022]
- [7] B. Ray, “The ZigBee Vs WiFi Battle For M2M Communication | Blog | Link Labs,” The ZigBee Vs WiFi Battle For M2M Communication | Blog | Link Labs, Nov. 02, 2015. [Online].

Available: <https://www.link-labs.com/blog/zigbee-vs-wifi-802-11ah>. [Accessed: May 08, 2022]

[8] D. Nayak, U. Nanda, P. Rout, S. K. Swain, S. M. Biswal, and S. K. Das, “Smart Power Pilferage Detection System,” ResearchGate, Mar. 0, 2019. [Online]. Available: https://www.researchgate.net/publication/334855634_Smart_Power_Pilferage_Detection_System. [Accessed: Apr. 28, 2022]

[9] R. G. Balakrishna, P. Y. Reddy, and M. L. N. Vital, “IoT Based Power Pilferage Detection,” dx.doi.org, Jun. 03, 2017. [Online]. Available: <http://dx.doi.org/10.21172/ijiet.83.016>. [Accessed: May 07, 2022]

[10] R. E. Ogu and G. A. Chukwudebe, “Development of a cost-effective electricity pilferage detection and prevention system based on IoT technology,” Development of a costeffective electricity pilferage detection and prevention system based on IoT technology, Nov. 10, 2017. [Online]. Available: <https://ieeexplore.ieee.org/abstract/document/8281943>. [Accessed: May 07, 2022]

[11] K. V. Blazakis, T. N. Kapetanakis, and G. S. Stavarakakis, “Effective Electricity Pilferage Detection in Power Distribution Grids Using an Adaptive Neuro Fuzzy Inference System,” MDPI, Jun. 16, 2020. [Online]. Available: <https://doi.org/10.3390/en13123110>. [Accessed: May 07, 2022]

[12] S. K. Gunturi and D. Sarkar, “Ensemble Machine Learning Models for the Detection of Energy Pilferage,” ScienceDirect.com, Mar. 0, 2021. [Online]. Available: <https://doi.org/10.1016/j.epsr.2020.106904>. [Accessed: Apr. 28, 2022]

[13] “In Bangladesh, Smart Grids Provide Over a Million People With Access to Electricity ,” afd.fr, Feb. 17, 2020. [Online]. Available: <https://www.afd.fr/en/actualites/bangladesh-smart-grids-provide-over-millionpeople-access-electricity>. [Accessed: May 08, 2022]

[14] “Rs 706-cr Power Theft Detected in 5 Years: Discom MD.” Tribuneindia News Service, 14 Sept. 2022, www.tribuneindia.com/news/haryana/706-cr-power-theft-detected-in-5-yrs-discom-md-431506?fbclid=IwAR3CBg3VbtSZbRPi0PfPA_9xrGJ7FZPueWoPLZ6me-Z7qNxOCSz2UI6HsXE

[15] PriyamvadaChandel, Tripta Thakur, B A Sawle, Rakhi Sharma, Power Theft: Major Cause of NonTechnical Losses in Indian Distribution Sector, 2016 IEEE 7th Power India International Conference.

[16] Dinesh B U, Shankar A M, Vishal B H, Vishwanath B K, Siddarameswara H N, GSM Based Electricity Theft Identification In Houses And In Industry Sector, International Conference on Electrical Electronics and Communications, Jun. 2014.

[17] Jindal, Anish, et al. "Decision Tree and SVM-Based Data Analytics for Theft Detection in Smart Grid." Decision Tree and SVM-Based Data Analytics for Theft Detection in Smart Grid | IEEE Journals & Magazine | IEEE Xplore, 16 Mar. 2016, doi.org/10.1109/TII.2016.2543145.

[18] Drive link for the sample data:

https://drive.google.com/file/d/1B0wgYpET19JDAig7uMlcH6H_ypcRpZk/view?usp=share_link

[19] AccuWeather Incorporation, Available: <http://www.accuweather.com/en/us/united-states-weather>, [Accessed: Dec. 2020].

[20] Open Energy Information, Available: <http://en.openei.org/datasets/dataset/commercial-and-residential-hourly-load-profiles-for-all-tmy3-locations-inthe-united-states>, [Accessed: December. 2022].

[21] "Efficient C4.5 [Classification Algorithm]." Efficient C4.5 [Classification Algorithm] | IEEE Journals & Magazine | IEEE Xplore, 7 Aug. 2022, doi.org/10.1109/69.991727.

[22] Arango, L. G., Deccache, E., Bonatto, B. D., Arango, H., Ribeiro, P. F., & Silveira, P. M. (2016). Impact of electricity theft on power quality. 2016 17th International Conference on Harmonics and Quality of Power (ICHQP). doi:10.1109/ichqp.2016.7783346

[23] Papai Bhakta, Suman Debnath, Partha Debnath, Paramita Das,Suparna Pal (2022). Power Theft Detection System (Review Paper).

[24] Editorial, “Squarely dealing with power pilferage | The Asian Age Online, Bangladesh, The Asian Age, Jan. 12, 2017. [Online]. Available: <https://dailyasianage.com/news/44359/squarely-dealing-withpower-pilferage>.

[25] S. Saini, “Social and behavioral aspects of electricity pilferage - An explorative review ,” ResearchGate, Jan. 0, 2017. [Online]. Available: https://www.researchgate.net/publication/323111353_Social_and_behavioral_aspects_of_electricity_pilferage_-_An_explorative_review. [Accessed: May 08, 2022]

[26] P. Das, “What Is A Green Product? - Examples, Advantages, & Challenges,” Feedough, Aug. 28, 2019. [Online]. Available: <https://www.feedough.com/green-product/#:~:text=A%20green%20product%20is%20a,waste%20and%20maximizing%20resource%20efficiency>. [Accessed: May 08, 2022]

[27] “Graduate Attributes and Professional Competencies”, Jun.21,2013-<https://www.ieagreements.org/assets/Uploads/Documents/Policy/Graduate-Attributes-and-Professional-Competencies.pdf> [Accessed: Dec, 2022]

[28] E. Nix, “Tuskegee Experiment: The Infamous Syphilis Study - HISTORY,” HISTORY, Dec. 15, 2020. [Online]. Available: <https://www.history.com/news/the-infamous40-year-tuskegee-study>. [Accessed: Apr. 28, 2022]

[29] “Nazi Medical Experiments | Holocaust Encyclopedia,” Nazi Medical Experiments | Holocaust Encyclopedia, Aug. 30, 2006. [Online]. Available: <https://encyclopedia.ushmm.org/content/en/article/nazi-medical-experiments>. [Accessed: Apr. 28, 2022]

[30] P. Bhandari, “A guide to ethical considerations in research,” Scribbr, Oct. 18, 2021. [Online]. Available: <https://www.scribbr.com/methodology/research-ethics/>. [Accessed: Apr. 28, 2022]

[31] “DESCO Safety Procedures Manual,” descocoatings.com, Sep. 0, 2018. [Online]. Available: <https://www.descocoatings.com/wp-content/uploads/2020/08/DescoSafety-Manual-September-2018.pdf>. [Accessed: Apr. 28, 2022]

[32] “Power Grid Company of Bangladesh LTD. Safety Manual,” pgcb.gov.bd, Jul. 01, 2006. [Online]. Available: https://web.pgcb.gov.bd/qms_documents/QD-TSS01.pdf/download. [Accessed: Apr. 28, 2022]

[33] “Occupational Health and Safety Manual,” pgcb.gov.bd, Apr. 15, 2021. [Online]. Available: https://web.pgcb.gov.bd/ohsas_documents/1/download. [Accessed: Apr. 28, 2022]

[34] BPDB, Bangladesh, “Annual Report,” bd.bpdb.gov.bd, Oct. 0, 2018. [Online]. Available: bd.bpdb.gov.bd/bpdb_new/resourcefile/annualreports/annualreport_1548580513_annualreport_1542104191_Annual_Report_2017-18_2.pdf. [Accessed: May 08, 2022]

Appendix.

Codes:

Related code/theory for Hardware (Arduino IDE):

The real-time current data verification code:

```
//Power Pilferage Detection and Identification System_FYDP_Group18
```

```
const int VIN1 = A0; // We used it for microcontroller Input
```

```
const float VCC = 5;
```

```
const int MODEL = 2;
```

```
#include <Robojax_AllegroACS_Current_Sensor.h> // Robojax_AllegroACS is the library  
that we used
```

```
Robojax_AllegroACS_Current_Sensor robojax1(MODEL,VIN1);
```

```
void setup()
```

```
{
```

```
  Serial.begin(9600);
```

```
  Serial.println("Power Pilferage Meter");
```

```
  Serial.println("Group-18, ATC-2");
```

```
  delay(5000);
```

```
}
```

```
void loop()
```

```
{
```

```
  Serial.print("Current found by Power Pilferage Dectector_group-18: ");
```

```
  Serial.print(robojax1.getCurrent(),3);
```

```
  Serial.print(" A Avg:");
```

```
  Serial.print(robojax1.getCurrentAverage(1000),3);
```

```
// 1000 was given to take the average of 1000 values
    Serial.println("A");
    delay(1500);
}
```

The code for the hardware components of the project, which will run the entire operation:

```
//Power Pilferage Detection and Identification System_FYDP_Group18
```

```
#include <EEPROM.h>
```

```
#include <LiquidCrystal.h>
```

```
LiquidCrystal lcd(3, 4, 5, 6, 7, 8);
```

```
#include <SoftwareSerial.h>
```

```
SoftwareSerial GSM(9 ,10);
```

```
#define buzzer 13
```

```
#define relay A5
```

```
#define bt_theft A0
```

```
#define pulse_in 2
```

```
//No Load 0.06
```

```
//Load 1 0.93
```

```
//Load 1 + Load 2 0.140
```

```
//Load 1 + Load 2 + Bypass Load 0.2
```

```
//Load 1 + Load 2 0.93
```

```
//Load 1 + Bypass Load 0.185
```

```
char inchar;
```

```

int unt_a=0, unt_b=0, unt_c=0, unt_d=0;
long total_unt =7;

int price = 0;
long price1 =0;
int Set = 10; // For the unit price that we from the pulse of Meter from PC817 octocopler
int pulse=0; // Won't show

String phone_no1 = "+8801679059498"; //For GSM
String phone_no2 = "+8801631283828";

int flag1=0, flag2=0, flag3=0;

void setup() {
Serial.begin(9600);
GSM.begin(9600);
pinMode(bt_theft, INPUT_PULLUP);
pinMode(relay,OUTPUT); //digitalWrite(relay1, HIGH);
pinMode(buzzer,OUTPUT);
pinMode(pulse_in, INPUT);
attachInterrupt(0, ai0, RISING);

lcd.begin(16, 2);
lcd.clear();
lcd.setCursor(5,0);
lcd.print("WELCOME TO");
lcd.setCursor(1,0);
lcd.print("Pilferage Meter"); // ATC-2 GROUP 18
digitalWrite(buzzer, HIGH);

```

```

initModule("AT","OK",1000);
initModule("ATE1","OK",1000);
initModule("AT+CPIN?","READY",1000);
initModule("AT+CMGF=1","OK",1000);
initModule("AT+CNMI=2,2,0,0,0","OK",1000);

lcd.setCursor(1,0); //Load 1+Bypass connected
lcd.print("Status: Abormal");
lcd.setCursor(1,1);
lcd.print("Run Inspection!");
delay(800000);
lcd.clear();

delay(100);
sendSMS(phone_no1,"Welcome To Energy Meter");
digitalWrite(buzzer, LOW); // Turn LED off
lcd.clear();

if(EEPROM.read(50)==0){ }
else{ Write();}

EEPROM.write(50, 0);

pulse = EEPROM.read(10);

Read();
if(total_unt>0){
digitalWrite(relay, HIGH);
}
}

```

```
}
```

```
void loop(){  
  if(GSM.available() >0){ // The GSM isn't Connected due to network issue.  
    inchar=GSM.read();  
    if(inchar=='R'){  
      delay(10);  
      inchar=GSM.read();  
      if(inchar=='U'){  
        delay(10);  
        inchar=GSM.read();  
        if(inchar=='c'){  
          delay(10);  
          inchar=GSM.read();  
          if(inchar=='o'){  
            delay(10);  
            inchar=GSM.read();  
            if(inchar=='d'){  
              delay(10);  
              inchar=GSM.read();  
              if (inchar=='e'){  
                delay(10);  
                inchar=GSM.read();  
                if(inchar=='reload1'){price = 100 / Set; total_unt = total_unt +price;  
                sendSMS(phone_no1,"Your Recharge is Update: 100");  
                sendSMS(phone_no2,"Your Recharge is Update: 100");  
                load_on();  
              }  
            }  
          }  
        }  
      }  
    }  
  }  
}
```



```
if(inchar=='t'){  
  delay(10);  
  inchar=GSM.read();  
  if(inchar=='a'){Data();}  
  }  
  }  
  }  
}
```

```
lcd.setCursor(0, 0);  
lcd.print("Unit:"); lcd.print(total_unt); lcd.print(" ");
```

```
lcd.setCursor(0, 1);  
lcd.print("Price:"); lcd.print(price1); lcd.print(" ");
```

```
lcd.setCursor(11, 0);  
lcd.print("Pulse");
```

```
lcd.setCursor(13, 1);  
lcd.print(pulse); lcd.print(" ");
```

```
if(total_unt==5){  
  if(flag1==0){ flag1 = 1;  
    digitalWrite(buzzer, HIGH);  
    sendSMS(phone_no1,"Your Balance is Low Please Recharge");  
    digitalWrite(buzzer, LOW);  
  }  
}
```



```

if(total_unt==0){
digitalWrite(relay, LOW);
if(flag2==0){ flag2 = 1;
digitalWrite(buzzer, HIGH);
sendSMS(phone_no1,"Your Balance is Finish Please Recharge");
digitalWrite(buzzer, LOW);
}
}

```

```

if(digitalRead (bt_theft) == 0){
if(flag3==0){ flag3 = 1;
sendSMS(phone_no2,"Theft Alarm");
}
}else{flag3 = 0;}

```

```

delay(5);
}

```

```

void load_on(){
Write();
Read();
digitalWrite(relay, HIGH);
flag1=0, flag2=0;
}

```

// Send SMS

```

void sendSMS(String number, String msg){
GSM.print("AT+CMGS=\"");GSM.print(number);GSM.println("\r\n");
delay(500);
}

```

```
GSM.println(msg);
```

```
delay(500);
```

```
GSM.write(byte(26));
```

```
delay(5000);
```

```
}
```

```
void Data(){
```

```
GSM.print("AT+CMGS=\"");GSM.print(phone_no1);GSM.println("\r\n");
```

```
delay(1000);
```

```
GSM.print("Unit:");GSM.println(total_unt);
```

```
GSM.print("Price:");GSM.println(price1);
```

```
delay(500);
```

```
GSM.write(byte(26));
```

```
delay(5000);
```

```
}
```

```
void Read(){
```

```
unt_a = EEPROM.read(1);
```

```
unt_b = EEPROM.read(2);
```

```
unt_c = EEPROM.read(3);
```

```
unt_d = EEPROM.read(4);
```

```
total_unt = unt_d*1000+unt_c*100+unt_b*10+unt_a;
```

```
price1 = total_unt*Set;
```

```
}
```

```
void Write(){
```

```
unt_d = total_unt / 1000;
```

```
total_unt = total_unt - (unt_d * 1000);
```

```
unt_c = total_unt / 100;
```

```
total_unt = total_unt - (unt_c * 100);
```

```
unt_b = total_unt / 10;
```

```
unt_a = total_unt - (unt_b * 10);
```

```
EEPROM.write(1, unt_a);
```

```
EEPROM.write(2, unt_b);
```

```
EEPROM.write(3, unt_c);
```

```
EEPROM.write(4, unt_d);
```

```
}
```

```
void initModule(String cmd, char *res, int t){
```

```
while(1){
```

```
    Serial.println(cmd);
```

```
    GSM.println(cmd);
```

```
    delay(100);
```

```
    while(GSM.available()>0){
```

```
        if(GSM.find(res)){
```

```
            Serial.println(res);
```

```
            delay(t);
```

```
            return;
```

```
        }else{Serial.println("Error");}}
```

```
    delay(t);
```

```
}
```

```
}
```

```
void ai0() { // ai0 is activated if DigitalPin nr 2 is going from LOW to HIGH
```

```
if(digitalRead(pulse_in)==1) {
```

```
pulse = pulse+1;
```

```
if(pulse>9){ pulse=0;
if(total_unt>0){total_unt = total_unt-1;}
Write();
Read();
}
EEPROM.write(10, pulse);
}
}
```

Code for the DT:

```
import numpy as nm
import matplotlib.pyplot as mtp
import pandas as pd
from sklearn.tree import DecisionTreeClassifier
from matplotlib.colors import ListedColormap
from sklearn.metrics import confusion_matrix
from sklearn.model_selection import train_test_split
from sklearn.preprocessing import StandardScaler
from sklearn.metrics import accuracy_score
from sklearn.metrics import classification_report, confusion_matrix

data_set= pd.read_csv('House_data01.csv')
x= data_set.iloc[:, [2,3,4,5,6,7]].values
y= data_set.iloc[:, 8].values
x_train, x_test, y_train, y_test= train_test_split(x, y, test_size= 0.25, random_state=0)
st_x= StandardScaler()
x_train= st_x.fit_transform(x_train)
x_test= st_x.transform(x_test)
classifier= DecisionTreeClassifier(criterion='entropy', random_state=0)
classifier.fit(x_train, y_train)
cm= confusion_matrix(y_test, y_pred)
x_set, y_set = x_train, y_train
x1, x2 = nm.meshgrid(nm.arange(start = x_set[:, 0].min() - 1, stop = x_set[:, 0].max() + 1, step =0.01),
nm.arange(start = x_set[:, 1].min() - 1, stop = x_set[:, 1].max() + 1, step = 0.01))
mtp.contourf(x1, x2, classifier.predict(nm.array([x1.ravel(), x2.ravel()]).T).reshape(x1.shape)
,
alpha = 0.75, cmap = ListedColormap(('purple','green' )))
mtp.xlim(x1.min(), x1.max())
```

```

mtp.ylim(x2.min(), x2.max())
fori, j in enumerate(nm.unique(y_set)):
mtp.scatter(x_set[y_set == j, 0], x_set[y_set == j, 1],
            c = ListedColormap(('purple', 'green'))(i), label = j)
mtp.title('Decision Tree Algorithm (Training set)')
mtp.xlabel('Power(KwH)')
mtp.ylabel('Output')
mtp.legend()
mtp.show()

x_set, y_set = x_test, y_test

x1, x2 = nm.meshgrid(nm.arange(start = x_set[:, 0].min() - 1, stop = x_set[:, 0].max() + 1, step = 0.01),
                    nm.arange(start = x_set[:, 1].min() - 1, stop = x_set[:, 1].max() + 1, step = 0.01))
mtp.contourf(x1, x2, classifier.predict(nm.array([x1.ravel(), x2.ravel()]).T).reshape(x1.shape)
,
alpha = 0.75, cmap = ListedColormap(('purple', 'green' )))
mtp.xlim(x1.min(), x1.max())
mtp.ylim(x2.min(), x2.max())
fori, j in enumerate(nm.unique(y_set)):
mtp.scatter(x_set[y_set == j, 0], x_set[y_set == j, 1],
            c = ListedColormap(('purple', 'green'))(i), label = j)
mtp.title('Decision Tree Algorithm(Test set)')
mtp.xlabel('Power(KwH)')
mtp.ylabel('Output')
mtp.legend()
mtp.show()

```

Code for the RF:

```
import numpy as np
import pandas as pd
from sklearn.model_selection import train_test_split
from sklearn.preprocessing import MinMaxScaler
from sklearn.metrics import accuracy_score
from sklearn.metrics import roc_curve, roc_auc_score
from imblearn.over_sampling import SMOTE
from sklearn.ensemble import RandomForestClassifier
from sklearn.metrics import confusion_matrix
import tensorflow as tf
from keras.models import Model
import matplotlib.pyplot as plt
power_consumption_data = pd.read_csv('House_data01.csv')
power_consumption_data.info()
power_consumption_data.head()
power_consumption_data.isnull().sum()
x = power_consumption_data.iloc[:,[0,1]]
y = power_consumption_data.iloc[:,2]
x_train, x_test, y_train, y_test = train_test_split(x, y, random_state=3)
x_scaler = MinMaxScaler().fit(x_train)
x_trained_scaled = x_scaler.transform(x_train)
x_scaler_test = MinMaxScaler().fit(x_test)
x_test_scaled = x_scaler_test.transform(x_test)
print(x_trained_scaled)
print(x_test_scaled)
smote = SMOTE()
x_train_re, y_train_re = smote.fit_resample(x_trained_scaled, y_train)
print(x_train_re)
```

```

print(y_train_re)

classifier = RandomForestClassifier(n_estimators= 12, criterion="entropy", n_jobs= 2, random_state= 3)

classifier.fit(x_train_re, y_train_re)

y_pred= classifier.predict(x_test)

print(y_pred)

ConfusionMatrix = confusion_matrix(y_test,y_pred)

display(ConfusionMatrix)

accuracy = accuracy_score(y_test,y_pred)

print('Overall Accuracy:', accuracy)

r_probs = [0 for _ in range(len(y_test))]

md_probs = classifier.predict_proba(x_test)

md_probs = md_probs[:, 1]

r_auc = roc_auc_score(y_test, r_probs)

md_auc = roc_auc_score(y_test, md_probs)

print('Random (chance) Prediction: AUROC = %.3f' % (r_auc))

print('Adaptive boosting: AUROC = %.3f' % (md_auc))

r_fpr, r_tpr, _ = roc_curve(y_test, r_probs)

md_fpr, md_tpr, _ = roc_curve(y_test, md_probs)

plt.plot(r_fpr, r_tpr, linestyle='--', label='Random prediction (AUROC = %0.3f)' % r_auc)

plt.plot(md_fpr, md_tpr, marker='.', label='Adaptive Boosting (AUROC = %0.3f)' % md_auc)

# Title

plt.title('ROC Plot')

# Axis labels

plt.xlabel('False Positive Rate')

plt.ylabel('True Positive Rate')

# Show legend

plt.legend() #

# Show plot

plt.show()

```

Code in node.js:

```
const http = require("http");

// PORT

const PORT = 3000;

// server

const server = http.createServer((req, res) => {

  if (req.url === "/") {

    res.write("This is home page.");

    res.end();

  } else if (req.url === "/about" && req.method === "GET") {

    res.write("This is about page.");

    res.end();

  } else {

    res.write("Not Found!");

    res.end();

  }

});

// server port

server.listen(PORT);

console.log(`Server is running on PORT: ${PORT}`);

/* ===== *** ===== */

/* create node.js server with express.js framework */

// dependencies

const express = require("express");

const app = express();
```

```
app.get("/", (req, res) => {
  res.send("This is home page.");
});

app.post("/", (req, res) => {
  res.send("This is home page with post request.");
});

// PORT
const PORT = 3000;

app.listen(PORT, () => {
  console.log(`Server is running on PORT: ${PORT}`);
});
```

Code for Node.js MySQL:

```
var mysql = require('mysql')

var con = mysql.createConnection({
  host: "localhost",
  user: "QQMZR",
  password: "123456"
});

con.connect(function(err) {
  if (err) throw err;
  console.log("Connected!");
  con.query("CREATE DATABASE mydb", function (err, result) {
    if (err) throw err;
    console.log("Database created");
    var sql = "CREATE TABLE power (time VARCHAR(255), powerkwh VARCHAR(255))";
    con.query(sql, function (err, result) {
      if (err) throw err;
      console.log("Table created");
      var sql = "INSERT INTO power (time, powerkwh)";
      con.query(sql, function (err, result) {
        if (err) throw err;
        console.log("1 record inserted");
      });
    });
  });
});
```