



***PERFORMANCE ANALYSIS OF MONO-CRYSTALLINE AND POLY-CRYSTALLINE
SILICON SOLAR CELLS UNDER DIFFERENT CLIMATIC CONDITIONS: A
COMPARATIVE STUDY***

**A Thesis submitted to the
Dept. of Electrical & Electronic Engineering, BRAC University
In partial fulfillment of the requirements for the
Bachelor of Science degree in Electrical and Electronic Engineering**

SHUVAJIT ROY

RAISA SADAT SHARMIN

TAJKIA FERDOUS

December 2014

Declaration:

We hereby declare that this thesis titled “ Performance analysis of mono-crystalline and polycrystalline silicon solar cells under different climatic conditions: A comparative study” and the work presented in it and submitted to the Department of Electrical and Electronics Engineering of BRAC University is our own and has been generated by us as the result of our own original research. It was not submitted elsewhere for the award of any other degree or any other publication.

Date:

Supervisor

Dr. Md. Mosaddequr Rahman

Shuvajit Roy (10221017)

Raisa Sadat Sharmin (10221060)

Tajkia Ferdous (10221061)

Acknowledgement:

We want to express our deepest gratitude to our thesis supervisor Dr. Mosaddequr Rahman, Professor of Department of EEE, BRAC University for his guidance and encouragement in completing our thesis work. Without his supervision and consistent help this thesis would not have been conceivable. His recommendations and precious directions helped us in successfully completing this thesis.

Abstract:

This study is based on dealing with two types of solar panels those are mono-crystalline and polycrystalline panels. We carried out the experiments to compare the efficiency and the cost for the two types of panels. In Bangladesh mostly polycrystalline panels are used to set up a solar energy system in a normal household where as our calculations suggested that mono-crystalline panel would be a better choice for installing in a home [9]. The main factors affecting the solar energy system that came in our concern was temperature and illumination. Depending on these two factors we saw how different cell parameters (series resistance, ideality factor, short circuit current, open circuit voltage, fill factor) varied. This in turn affects the cell performance and output. This work aims to study the effect on the behavior of both mono-crystalline and poly-crystalline silicon solar panel and develop a comprehensive model to calculate the cell output that takes into account the effect of different parameters under different environmental conditions. The model is used to calculate the cumulative cell output for over a year for the two types of solar panel.

Table of contents

1.Introduction.....	5
1.1 Background.....	5
1.2 Literature review.....	5
1.3 Scope of work.....	6
1.4 Thesis organization.....	7
1.4.1 Solar radiation.....	7
1.4.2 Basic theory of a solar cell.....	7
1.4.3 Experimental result and analysis.....	7
1.4.4 Power and energy calculations	8
1.4.5 Economic analysis.....	8
1.4.6 Conclusion.....	8
2. Solar radiation.....	9
2.1 Introduction.....	9
2.2 Finding the value of air mass.....	10
2.3 Declination angle calculation.....	10
2.4 Hour angle calculation.....	11
2.5 Conclusion.....	12
3. Basic theory of solar cell.....	13
3.1 Introduction.....	13
3.2 Basic operation of a solar cell	13
3.2.1 P-n junction.....	13
3.2.2 Photocurrent.....	14
3.3 Structure and materials of solar cells.....	14
3.3.1 Mono-crystalline silicon solar cell.....	15
3.3.2 Poly-crystalline silicon solar cell.....	15
3.3.3 Difference between mono-crystalline and poly-crystalline silicon solar cell.....	16
3.4 Electrical equivalent circuit.....	16
3.5 The effect of illumination on short circuit current.....	17
3.6 Effect of temperature.....	17
3.6.1 Effect of temperature on short circuit current (I_{sc})	17
3.6.2 Effect of temperature on open circuit voltage (V_{oc}).....	17
3.6.3 Effect of temperature on reverse saturation current (I_o).....	18
3.7 Calculation of the series resistance (R_s) of the solar panel.....	20
4. Experimental result and analysis.....	22
4.1 Introduction.....	22
4.2 Indoor monitoring system.....	22
4.3 Calculation of ideality factor.....	23
4.3.1 Theoretical analysis of the calculation of the ideality factor (n).....	23
4.3.2 Experimental analysis for calculating the ideality factor (n).....	25
4.3.2.1 Block diagram of the experiment.....	25
4.3.2.2 Description of the experimental process.....	25
4.3.2.3 Conditions for experimental calculation of n	26
4.3.2.4 Result and analysis of the experimental value of n.....	27
4.4 Obtaining the I-V sweep curve of the solar module at different temperature.....	28

4.4.1	Theoretical analysis for plotting I-V sweep curves of a solar module.....	28
4.4.2	Experimental analysis for plotting I-V sweep curves of a solar module.....	28
4.4.2.1	Description and conditions of the experimental procedure.....	28
4.4.2.2	Block diagram of the experimental setup for getting I-V sweep curves....	30
4.5	Result and analysis.....	30
4.5.1	I-V sweep curves at different temperature.....	30
4.5.2	Effect of temperature on short circuit current.....	33
4.5.3	Effect of temperature on open circuit voltage.....	34
4.5.4	Effect of temperature on maximum power point.....	36
4.5.5	Effect of temperature on fill factor.....	38
4.6	Analyzing the effect of temperature on series resistance.....	40
4.6.1	Theoretical analysis for calculation of R_s	40
4.6.2	Experimental procedure for calculating R_s	41
4.6.3	Conditions for calculating R_s	42
4.6.4	Block diagram of the experiment.....	42
4.6.5	Results and Analysis.....	43
4.6.6	Conclusion.....	44
5.	Power and Energy Calculation.....	46
5.1	Introduction.....	46
5.2	Process of Energy Calculation.....	47
5.3	Graphs of solar radiation and temperature	48
5.4	Results and Comparison.....	50
5.5	Outdoor Experiment.....	52
5.5.1	Circuit Diagram of the experiment.....	53
5.5.2	Data Collection method.....	54
5.5.3	Result of outdoor experiment and comparison.....	55
6.	Economic Analysis.....	56
6.1	Introduction.....	56
6.2	Solar with grid tied system.....	56
6.3	Stand alone solar power system.....	56
6.4	Solar energy system with inverter and charge controller.....	57
6.5	Energy Extracted.....	58
6.6	Equations for set-up cost.....	58
6.7	Set-up cost.....	59
6.8	Conclusion.....	63
7.	Conclusion.....	64
8.	References.....	65
9.	Appendix	

CHAPTER 1

INTRODUCTION

1.1 Background:

Bangladesh has been facing load shedding problems for many years now. The total electricity production in Bangladesh does not meet our needs, that is, it is not sufficient for us [1]. The government had pledged that there will be no more power cuts from 2012, yet the country is experiencing around 700MW of load-shedding a day and unofficially it would be around 1500MW [2]. Maximum load-shedding problems occur in Dhaka city; due to shortage of gas PDB is unable to produce the extra amount of electricity that is required, which leads us to the main reason behind our emphasis on solar power [3]. Solar power is also needed, as it is eco friendly; for example, global warming is the issue of consideration in the recent times [4]. Great awareness is created all over the world in trying to decrease the effects of global warming. Everyday large amount of harmful by products and toxic gases are released in our eco system [4]. Nowadays world is depending more and more on solar energy because it is both renewable and clean source of energy, it does not emit the toxic gases into the environment [5]. Oils, coals, etc. are going to extinct someday, but this renewable form of energy will always be there to support us[6].

1.2 Literature review:

Our work starts with analyzing the simple existing electrical model of the solar cell, then gradually we proceed towards the factors that influence the cell parameters, and for which the output of the solar cell is dependent. From several research papers, and works done up to date, we found that, temperature and illumination are the key factors that heavily influence the parameters of the cell, that is I_{sc} (short circuit current), V_{oc} (open circuit voltage), R_s (series resistance of a cell), P_{max} (maximum power output), and hence the output changes.

Our thesis work consists of two types of cell, which is mono-crystalline and poly-crystalline silicon solar cell. Firstly the output of the two types of solar cell is calculated analytically, without taking account of the affect of the factors, affecting the panel parameters. Later, we analyze the affect due to temperature and illumination on the panel parameters (I_{sc} , V_{oc} and R_s), and then compare the output of the cells.

The main aim of this thesis work is to calculate the energy that can be extracted from this two types of silicon solar cell, considering the factors affecting the parameters, and then by economic analysis we conclude which type of solar cell is most cost-efficient for using.

In order to achieve our purpose, lots of theoretical analysis has been done, after that by indoor monitoring system we found out the variation of panel parameters with temperature, and use that to iterate the value of current (I), by Newton-Raphson iteration method by MATLAB simulation. Maximum power output is calculated from the I-V characteristics curve obtained by the iteration method; hence the energy calculation has been done by integrating the maximum power versus time curve.

This process of energy calculation has been repeated for extracting energy from the two types of solar cell over one-year period. In our work we have considered the climatic condition of Dhaka city, for taking the temperature data, and calculating illumination on the year of 2013. Lastly, our work has been verified by taking outdoor data, which resembles our analytical result.

1.3 Scope of work:

The scope of this thesis work includes monitoring the variation of panel parameters, that is I_{sc} (short circuit current), V_{oc} (open circuit voltage), R_s (series resistance), and P_{max} (maximum power output) of the solar cell, with temperature and illumination. Indoors experiment has been carried out by controlling the environmental factors for obtaining the relationship of the panel parameters with temperature and illumination. LM35 has been used to measure the temperature of both the panels. RTC circuits keeps the track of the real time and date of the measured data, ACS714 allows to measure the current flowing through the panels, and relay is used for switching purpose, for taking data between the two panels respectively within a given time interval. All the circuits are connected to Arduino Mega 2560, to measure and record all the data. Computation has been done by MATLAB simulation after getting the curves obtained from the experimental data, and hence the comparison takes place.

1.4 Thesis organization:

This thesis is organized in such an order, so that the simplest models are explained first, and then gradually we proceed towards the factors to be considered. The calculation of the environmental factors is well explained, before approaching towards modeling of the PV cell. Basic theory of the solar cell is explained, from where we deduced the procedure of conducting the indoor experiment, and the experiments are explained step by step along with diagrams. The content of the chapters in this paper are explained in brief below:

1.4.1 Solarradiation:

Here we discussed about the position of the sun according to the 24-hour time interval, found the declination angle, solar altitude and the hour angle using formerly deduced formula. All these values are needed to calculate the variation of solar illumination with time. The values of the illumination are then used to calculate the panel parameters, which are dependent on solar illumination.

1.4.2 Basic theory of solar cell:

This chapter basically discuss about the structure, operation of a solar cell, including the properties, characteristics and differences between mono-crystalline and poly-crystalline silicon solar cells. The discussion is followed by the explanation of the existing simple electrical model of a solar cell. Then we further proceed towards the derivation of the equation of the panel parameters, and finally derived the equations by which we can say that the parameters are affected due to temperature and illumination.

1.4.3 Experimental result and analysis (Indoors-monitoring system):

The chapter starts with a brief introduction of the indoors-monitoring system, and how the system is used to examine several parameters of the solar panel. The block diagrams, along with the circuit setup diagram, explain the experiments conducted. The results are described by the graphs obtained from the MATLAB simulation of the experimental data. This chapter basically gives the overview, how the various parameters (I_{sc} , V_{oc} , P_{max} , FF , and R_s) behave when temperature changes, and we also calculated the value of the ideality factor of the panels by this indoor-monitoring system. All these values played a vital role in our analytical calculation of the energy extracted from the panels.

1.4.4 Power and energy calculation:

The theoretical analysis gives us the equations from which we calculated the various parameters of the solar cell, using those values the energy estimation has been done in this paper. This chapter starts with a flowchart, showing the steps done for calculating the energy over a day, and then how the calculation is done for a year. The chapter continues with graphs showing the variation of average monthly temperature, and illumination of Dhaka city for the year of 2013, and the energy extracted on different times of the year from both the panels. Comparison between the two types of cell has been done using the result of the analytical study, firstly by panel data and then using the experimental results.

This chapter ends with the verification of our work, by taking outdoor data of the solar panels, and discussing whether our analytical results resembles with the practical data.

1.4.5 Economic analysis:

We have discussed about the three types solar energy systems that are available for setup in our country, followed by the total costing of the system (for 600W load) considering their lifespan and durability. We calculated the cost of per kilowatt-hour energy for the different systems, and concluded the chapter by commenting the most efficient system of solar panel that can be used.

1.4.6 Conclusion:

The last chapter discuss about the efficient output from the solar cell that varies with season according to the climatic condition of Dhaka city, and later gives an conclusion on the works we have done up to date.

CHAPTER 2

SOLAR RADIATION

2.1 Introduction:

Sunlight that reaches the surface of the earth cannot be completely used for producing electricity. Many are scattered, some are reflected and some are absorbed by the earth's atmosphere. All of these components of sunlight have been given names of their own. Sunlight that reaches the earth's surface without scattering is called direct or beam radiation. Scattered sunlight is called diffuse radiation. Sunlight that is reflected from the ground is called albedo radiation and the sum of all three components of sunlight is called global radiation. The amount of sunlight absorbed and scattered depends on the length of distance travelled by the light wave through the atmosphere. This path length is compared to the vertical path directly to sea level, which is designated as air mass, when this condition is satisfied air mass = 1. As a result the air mass changes with the change in position of sun depending on the angles of the sun. At different AM the intensity of the global radiation will decrease from 1367 W/m² at the top of the atmosphere to just over 1000 W/m² at sea level. Hence for different AM 1 path length, the intensity of sunlight will decrease to 70% of the original AM0 value. The equation form for finding the intensity would be

$$I = 1367(0.7)^{(AM)^{0.678}} \quad (2.1)$$

Where,

I = solar illumination,

AM = air mass,

To execute this equation to find intensity we need to find the **air mass** value. In order to do that we needed to follow some specific steps, explained below.

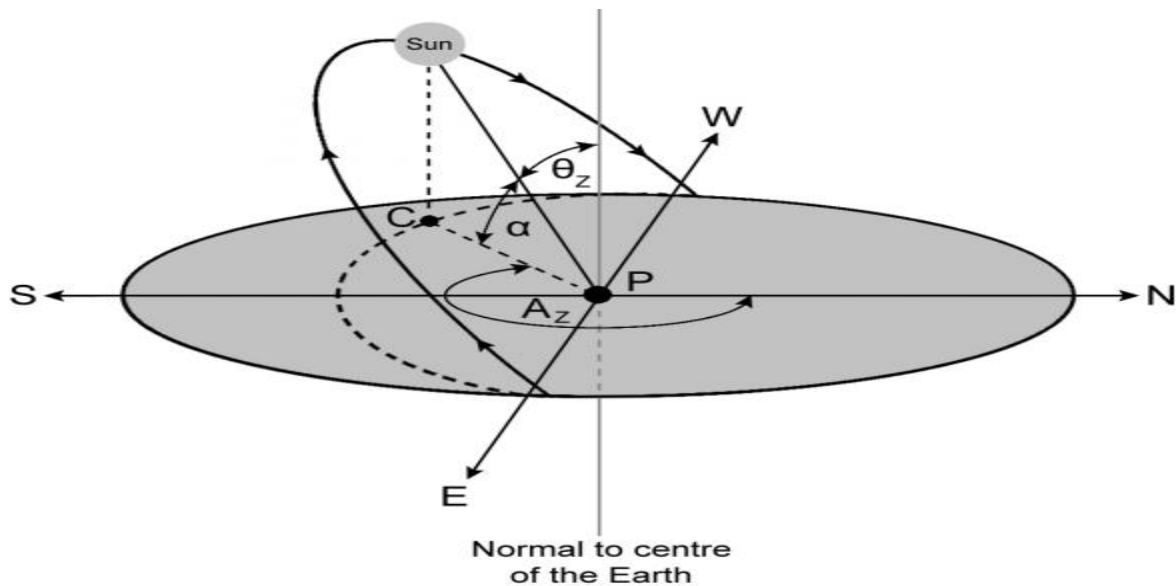

Figure- 2.1: Sun angles, showing altitude, azimuth, zenith, and hour angle [7].

2.2 Finding the value of air mass:

The equation for calculating air mass (AM) is given below

$$AM = AM(90^\circ) \csc\alpha \quad (2.2)$$

For this equation to work we needed the value for α . The complement of the zenith angle, θ_z , is called the solar altitude, α . This represents the angle between the horizon and the incident solar beam in a plane determined by zenith and the sun. The zenith is a line perpendicular to the Earth (i.e., straight up). The **zenith** angle, θ_z , is defined as the angle between the sun and the zenith.

2.3 Declination angle calculation:

Another point we needed to consider is the **declination angle**. It is defined as the angle of deviation of the sun directly above the equator, δ . If angles north of the equator are considered to be positive and the south are considered to be negative, then at any given time of the year, n , the declination can be found from

$$\delta = 23.45^\circ \sin\left(\frac{360(n-80)}{365}\right) \quad (2.3)$$

Since the sun is directly overhead on the first day of summer at solar noon on the Tropic of Cancer, it becomes evident that

$$\theta_z = \phi - \delta \quad (2.4)$$

Where ϕ represents the latitude, or angular distance from the equator, since when the declination and the latitude are the same, zenith angle is zero, this is only true at latitude during solar noon. This equation is mainly used to locate the position of the sun. So by using this equation we find the zenith angle.

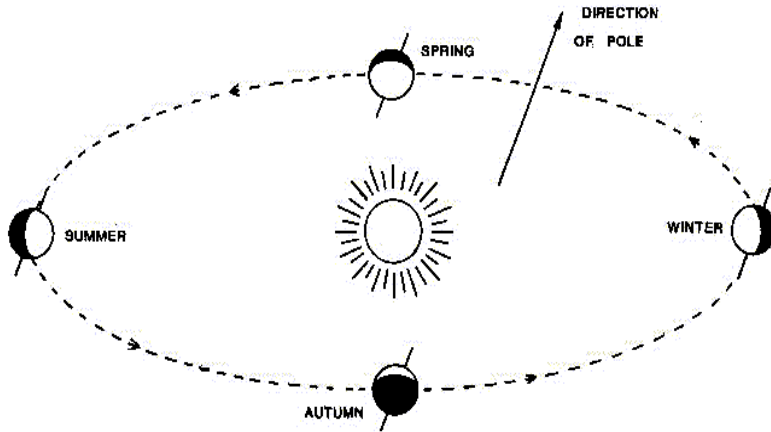

Figure-2.2: The orbit of the Earth, at different times of the year [7].

2.4 Hour angle calculation:

Another useful angle in attaining the position of the sun is the angular displacement of the sun from solar noon in the plane of apparent travel of the sun. The **hour angle** is the difference between noon and the desired time of the day in terms of a 360° rotation in 24 hours. Equation for finding the hour angle, ω is given as:

$$\omega = \frac{12-T}{24} \times 360^\circ \quad (2.5)$$

Where T is the time of the day expressed to a solar midnight, on a 24 hour clock. By relating ω to the other angles previously explained, we get the sunrise angle.

$$\omega_s = \cos^{-1}(-\tan\phi \tan\delta) \quad (2.6)$$

Which, in turn, implies that the sunset angle is given by $-\omega_s$. This formula is useful as it determines the number of hours sun remains above the horizon on a specific day under a specific latitude.

2.5 Conclusion:

Finally α can be determined by the formula given below (equation (2.7)). We already know the values for δ , ϕ and ω from the equations above.

$$\sin\alpha = \sin\delta\sin\phi + \cos\delta\cos\phi\cos\omega \quad (2.7)$$

Using equation (2.7) we get the value for the **solar altitude**, α . Putting this value in the equation for air mass, we get the AM value and using AM value we accomplish our motto by calculating the intensity using equation(2.1).

After doing the calculations, and simulation in MATLAB, we can see how the illumination varies with time over the day.

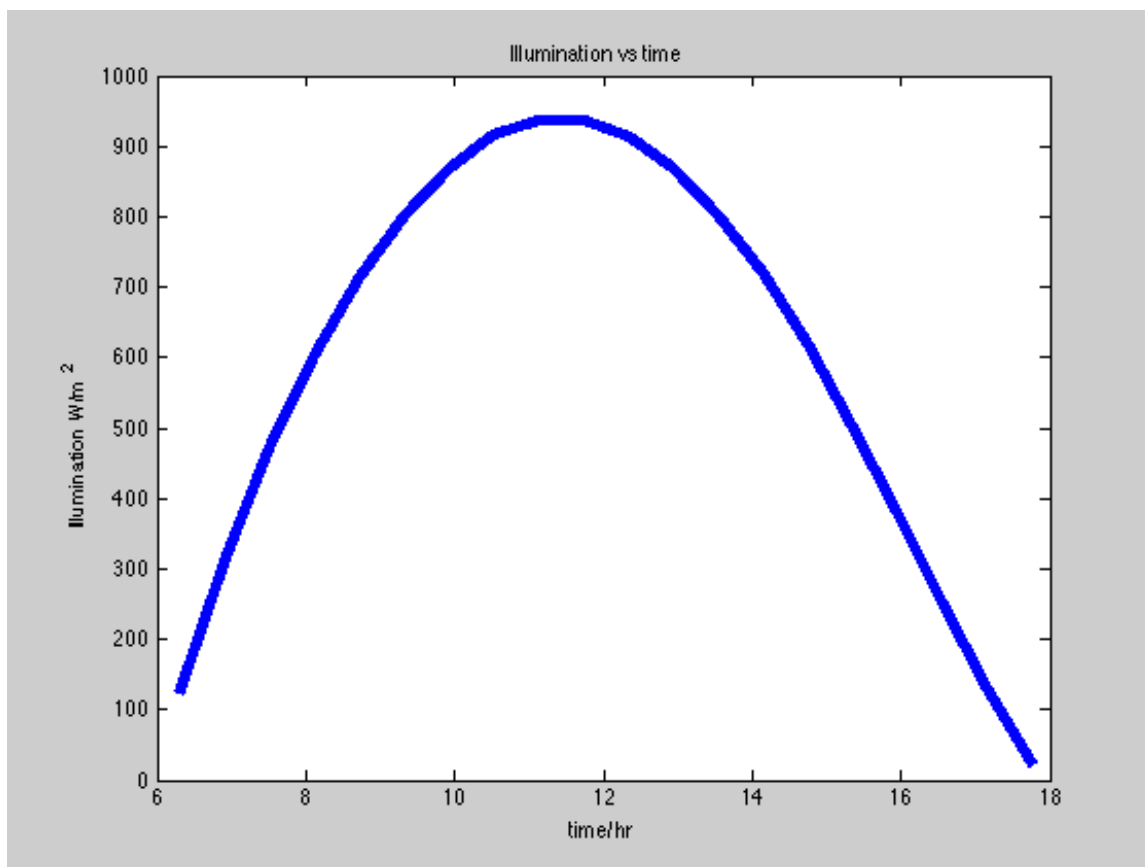

Figure: 2.3 – Graph showing how illumination in Dhaka (03/04/13) varies with time through out a day.

CHAPTER 3

BASIC THEORY OF SOLAR CELL

3.1 Introduction:

A solar cell is a solid-state electronic device (p-n junction) that converts the energy of light directly into DC electricity using the photovoltaic effect. The process of conversion requires a material, which absorbs the solar energy (photon) and then excites an electron to a higher energy state. This electron then flows to the external circuit by DC current. The material used for this purpose is silicon.

3.2 Basic operation of solar cell:

3.2.1 P-n junction:

A p-n junction is formed by joining p-type semiconductor material and n-type semiconductor material. P-type consists of high concentration of holes and n-type is formed high concentration of electrons. On joining the p and n type material holes from the p-type material diffuse into the n-type material and vice versa. Due to this effect a depletion region is formed in between the p-n junction where an electric field is produced. This process continues until an equilibrium state is established.

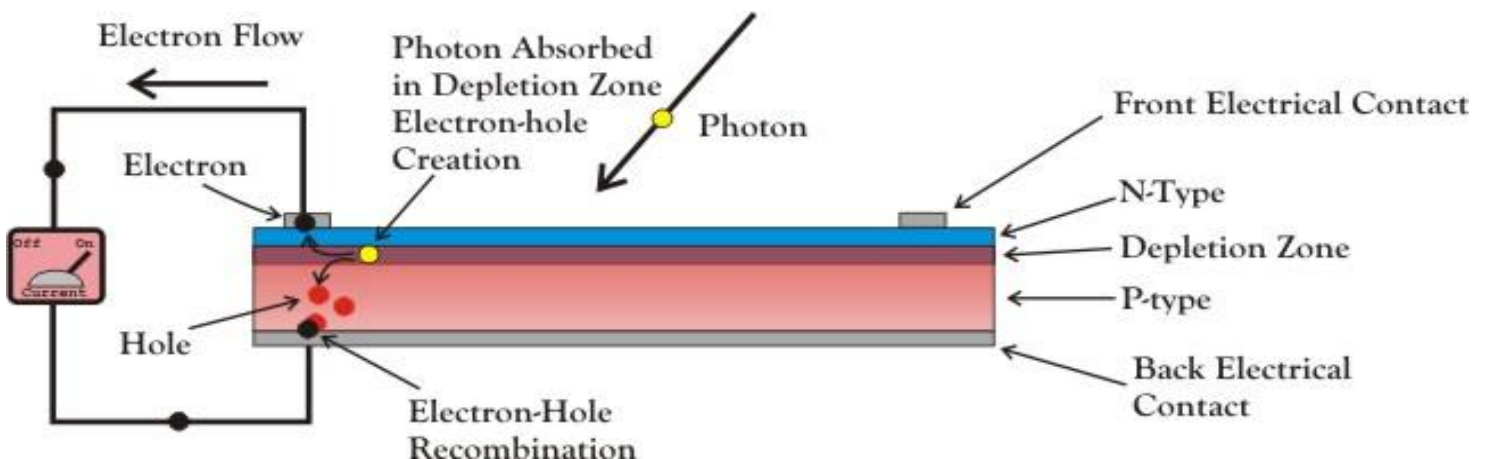

Figure-3.1: Working principle of a p-n junction. [9]

3.2.3 Photocurrent:

When light is incident on a p-n junction electron hole pair is generated. Electron hole pair is only generated when the photon have sufficient energy than the band gap energy. The holes in the n-type material and the electrons in the p-type material are very non stable and they exist only for a length of time equal to the minority carrier lifetime before they recombine. If they recombine than no current is generated as all the electron hole pair are lost.

P-n junction prevents this recombination, which separate the electron and holes. The electric field in the p-n junction separates the carriers. When the photo generated carriers reach the depletion region they are pulled across the other side by the action of the electric field. These carriers than flow through the external circuit, consisting the flow of electric current.

3.3 Structure and materials of solar cells:

In a solar cell the absorption of photon, which results in the generation of charge, carriers and the subsequent separation of the photo generated charge carriers take place in the semiconductor materials. This process of conversion of energy of photons into electrical energy has many advantages and drawbacks. Solar cells consist of a top and bottom metallic grid, which collect the diffused charger carriers and collects the cell to the load. A thin layer of anti-reflective coating covers the top side of the cell do decrease the reflection of light from the cell. To protect the cells from outer environment a glass sheet is spread above it.

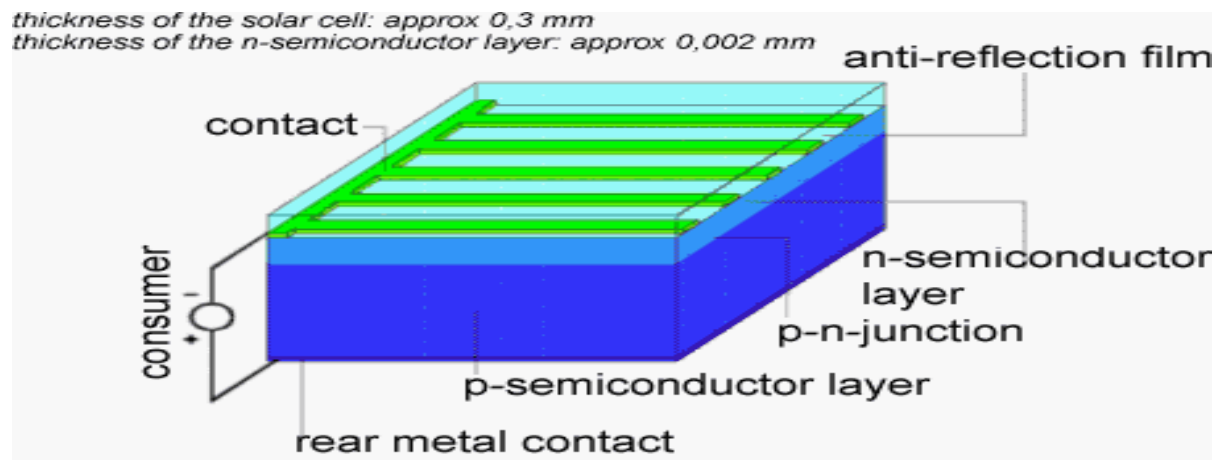

Figure-3.2: Structure of a solar cell [10].

3.3.1 Mono crystalline silicon solar cell:

Mono-crystalline solar cells are made from so-called single crystalline solar cells and easily recognizable from its color and its uniform look which indicates that there is a high purity of silicon. It is made up of silicon ingots and has a cylindrical shape. In order to make its performance better and reduce the cost the four side of its cells are cut to make cylindrical ingots from which cylindrical wafers can be made, which distinguishes it from others. They are dark black color solar cells.



Figure: 3.3 - Mono-crystalline silicon solar panel [11].

3.3.2 Poly-crystalline silicon solar cell:

Poly-crystalline silicon is material consisting of multiple small silicon crystals. Poly-crystalline silicon are melted and poured into square mold, which is cooled and cut into perfectly square wafers. They are not uniform so they are light and dark blue color.

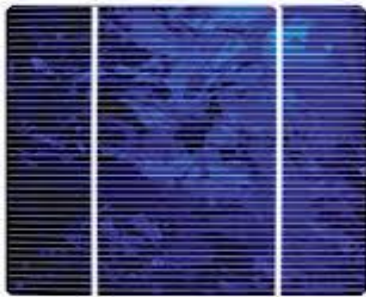

Figure: 3.4- Poly-crystalline silicon solar panel [10].

3.3.3 Difference between mono-crystalline and poly-crystalline silicon solar cell:

With respect to poly crystalline panels, mono crystalline panel have a higher efficiency and are more available than poly silicon solar cells.

Mono crystalline solar cells are space-efficient, i.e. they yields highest power output and the least amount of space than the polycrystalline.

Mono crystalline panels are more expensive than polycrystalline and also have a higher heat tolerance

Mono crystalline panels have a longer life span than the others and they tend to be more efficient.

3.4 Electrical equivalent circuit:

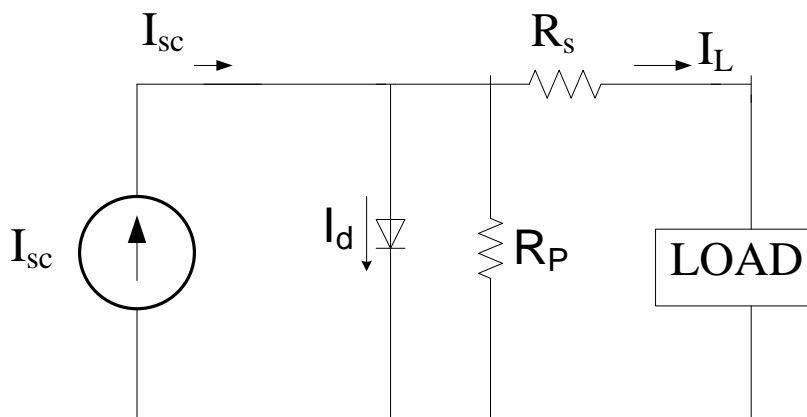

Figure: 3.5- Electrical equivalent circuit of a PV cell.

This is the electrical equivalent circuit of a solar panel. Where,

I_{sc} = short circuit current

I_0 = reverse saturation current

R_s = series resistance of the panel

R_p = parallel resistance of the panel

V_T = thermal voltage

n = ideality factor

I_L = load current

The equation for the electrical equivalent circuit is

$$I_L = I_{SC} - I_0 \exp \left[\frac{V + IR_S}{nV_T} \right] \quad (3.1)$$

3.5 The effect of illumination on short circuit current (I_{SC}):

The short circuit (I_{SC}) is dependent on the illumination of the sun. One illumination is the illumination given on the solar panel and another illumination is the illumination taken on a particular time. The equation is

$$I_{SC,new} = I_{SC,ref} \left(\frac{l_2}{l_1} \right) \quad (3.2)$$

Where,

$I_{SC, new}$ = short circuit current at a given time

$I_{SC, ref}$ = short circuit current at reference temperature

l_2 = illumination in a new temperature

l_1 = illumination in the reference temperature

3.6 Effect of temperature:

The effect of temperature on panel parameters is derived below.

3.6.1 Effect of temperature on short circuit current (I_{sc}):

The effect of temperature on short circuit current is obtained from the indoor monitoring system and it will be discussed later in the chapter.

The relationship that we obtained from the indoor monitoring system for mono-crystalline silicon solar panel is $I_{SC} = 0.0011 * T + 0.084$ therefore the temperature coefficient is 1.1mA/K

For polycrystalline it is $I_{SC} = 0.00096 * T + 0.12$ so the temperature coefficient for polycrystalline silicon solar cell is 0.096mA/K.

3.6.2 Effect of temperature on the open circuit voltage (V_{OC}):

The open circuit voltage decreases with temperature and we have already verified that

$V_{oc} = -0.0018 * T + 1.1$ For one cell of mono crystalline and $V_{oc} = -0.0017 * T + 1.1$ for one cell of poly crystalline silicon solar cell. We verified it through the indoor experiment but theoretically we have seen that that the V_{OC} for mono crystalline silicon solar cell is $2mV/^{\circ}C$ and which is same for poly crystalline solar cell as well but our indoor analysis shows that the temperature coefficient is $1.8mV/^{\circ}C$ for mono crystalline and $1.7mV/^{\circ}C$.

3.6.3 Effect of temperature on reverse saturation current (I_0):

The current through the cell is given by the equation below

$$I = -I_{sc} + I_o \left[\exp\left(\frac{eV_{oc}}{nKT}\right) - 1 \right]$$

When the current through the cell is zero ($I=0$), the equation is as follows

$$I_o \left[\exp\left(\frac{eV_{oc}}{nKT}\right) - 1 \right] = I_{sc} \quad (3.3)$$

Then the equation for I_o in terms of I_{sc} is

$$I_o = \frac{I_{sc}}{\exp\left(\frac{eV_{oc}}{nKT}\right) - 1}$$

Ignoring 1, the equation becomes

$$I_o = \frac{I_{sc}}{\exp\left(\frac{qV_{oc}}{nKT}\right)} \quad (3.4)$$

At reference temperature and illumination

$$I_o = \frac{I_{sc}}{\exp\left(\frac{V_{oc}}{nV_T}\right)} \quad (3.5)$$

Where $V_T = \frac{KT}{q}$

For finding the temperature dependence on the reverse saturation current, we analyze the following equations:

For a regular p-n junction the ideal saturation current is

$$I_0 = AqN_cN_v(B) \exp\left(-\frac{E_g}{KT}\right), \text{ Where} \quad (3.6)$$

I_0 = reverse saturation current,

A= area

q = charge of an electron

N_c = effective density of states in conduction band

N_v = effective density of states in valence band

E_g = energy band gap

K= boltzmann's constant

T= temperature

and “B” is a constant

The effective density of states can be expressed as:

$$N_{C1} = 2 * \left(\frac{2\pi m_e KT_1}{h}\right)^{1.5} \quad (3.7)$$

At a new temperature the effective density changes as follows:

$$N_{C2} = 2 * \left(\frac{2\pi m_e KT_2}{h}\right)^{1.5} \quad (3.8)$$

Dividing equation (3.7) by (3.8), we get :

$$\frac{N_{C2}(T_2)}{N_{C1}(T_1)} = \left(\frac{T_2}{T_1}\right)^{1.5}$$

Therefore,

$$N_{C2}(T_2) = N_{C1} * \left(\frac{T_2}{T_1}\right)^{1.5} \quad (3.9)$$

Hence, the effective density of states in valence band can also be expressed as

$$N_{V2}(T_2) = N_{V1} * \left(\frac{T_2}{T_1}\right)^{1.5} \quad (3.10)$$

At T_2 ,

$$I_0(2) = A_q N_{C1} * \left(\frac{T_2}{T_1}\right)^{1.5} * N_{V1} * \left(\frac{T_2}{T_1}\right)^{1.5} \exp\left(-\frac{E_g}{KT}\right)$$

$$I_0(1) = A_q N_{C1} N_{V1} \exp\left(-\frac{E_g}{KT_1}\right)$$

$$\frac{I_0(2)}{I_0(ref)} = \frac{\left(\frac{T_2}{T_1}\right)^3 \exp\left(-\frac{E_g}{KT_2}\right)}{\exp\left(-\frac{E_g}{KT_1}\right)}$$

$$I_0(2) = I_0(ref) * \left(\frac{T_2}{T_1}\right)^3 \exp\left[\frac{E_g}{q} \left(\frac{1}{T_2} - \frac{1}{T_1}\right)\right]$$

At new temperature the reverse saturation current can be calculated as

$$I_{new} = I_0 \left(\frac{T_1}{T_0}\right)^3 \exp\left[\frac{-E_g}{k/q} \times \frac{1}{T_i} - \frac{1}{T_0}\right] \quad (3.11)$$

3.7 Calculation of the series resistance (R_s) of the solar panel:

At maximum power point the current flowing through the solar panel can be rated as the maximum operating current, and voltage can be said as maximum operating voltage and can be denoted by the equation:

$$I_{mpp} = I_{sc} - I_0 \exp\left(\frac{V_{mpp} + I_{mpp} * R_s}{nV_T}\right) \quad (3.12)$$

$$\frac{V_{mpp} + I_{mpp} * R_s}{nV_T} = \ln\left(\frac{I_{sc} - I_{mpp}}{I_0}\right)$$

$$R_s = \left[nV_T \ln\left(\frac{I_{sc} - I_{mpp}}{I_0}\right) - V_{mpp} \right] * \frac{1}{I_{mpp}} \quad (3.13)$$

Where,

R_s = series resistance of a solar cell,

I_{mpp} = maximum operating current of the cell,

V_{mpp} = maximum operating voltage of the cell,

I_{sc} = short circuit current,

n = ideality factor of the cell,

I_0 = reverse saturation current,

V_t = thermal voltage of the cell.

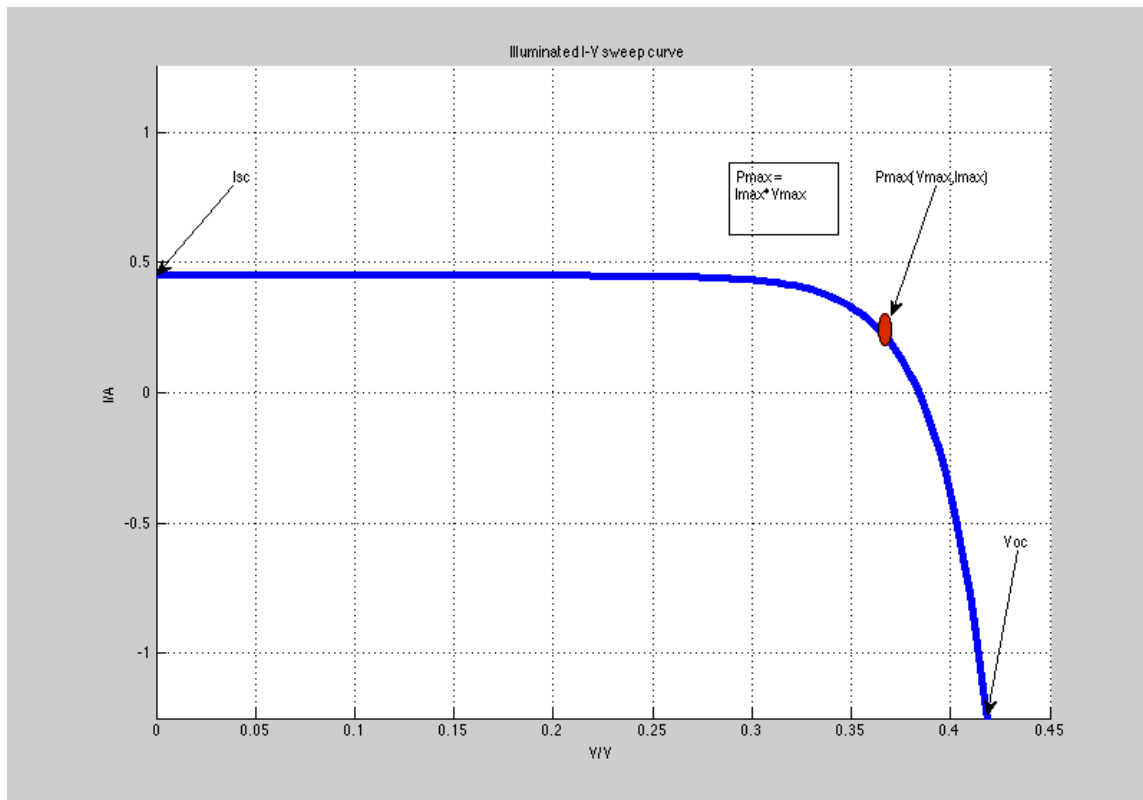

Figure- 3.6 : Calculating R_s from the maximum operating current and voltage.

CHAPTER 4

EXPERIMENTAL RESULT AND ANALYSIS

4.1 Introduction

We are analyzing the performance of silicon solar cells under different climatic conditions, after which we are going to make a comparative study between mono-crystalline and polycrystalline Silicon solar module. As our study is due to different climatic conditions, then temperature effects on solar module parameters play a vital role of consideration. Here, we are analyzing the different parameter of the solar cell using indoor monitoring system under illumination of light, where temperature and illumination of light can be controlled according to our needs. There are different parameters in a solar cell and we are to see how this parameter varies with temperature. Such parameters are open circuit voltage- V_{oc} , short circuit current- I_{sc} , series resistance of a photovoltaic cell- R_s , maximum power output point- P_{max} , fill factor-FF, maximum working current- I_{mp} , maximum working voltage- V_{mp} , we will then plot a graph against each of these parameter verses the temperature and see how these changes with temperature. The temperature coefficients of these parameters are very essential to know the behavior of the panel, then we can figure it out how it is changing with temperature, and affecting on the output power of the panel, and how much of energy these can provide.

4.2 Indoor- monitoring system:

The data required for analyzing the solar panel can be tested outdoor in the roof but in that case there are many restrictions, as we cannot control many parameters while being there. So we developed an indoor system of testing the panel where we can control many parameters like temperature, illumination. The system is very simple, it is wooden box with eight bulb fitted in it each containing 200 W. The whole box is wrapped with shiny paper from inside so that no light can escape the box and all the light reflected from the box will fall in the solar panel. This technique will help us to have more illumination on the panel.

4.3 Calculation of the ideality factor (n) of the solar module

4.3.1 Theoretical Analysis for the calculation of the ideality factor (n):

We carried out our experiment to find the ideality factor (n), of a Silicon solar cell based on the predefined electrical model on a photovoltaic cell; by analyze the circuit, using different equations given below:

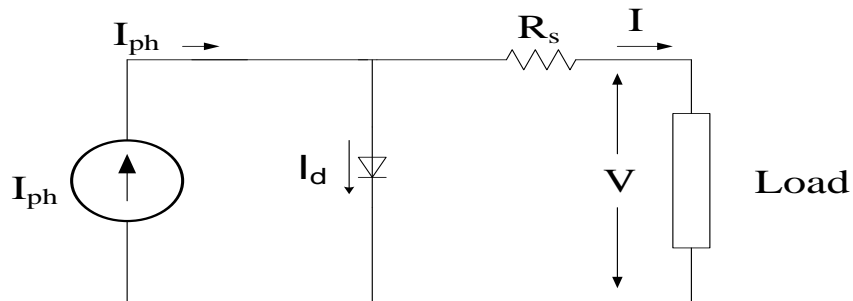

Figure-4.1: Simplified Equivalent Circuit Model for a Photovoltaic Cell connected with a load.

$$I_{ph} = I + I_d \quad (4.1)$$

Where I_{ph} is the photocurrent, I_d is the diode current and I is the load current.

$$I_{ph} = I_{sc} \quad (4.2)$$

In the equation (4.2), I_{sc} is the short circuit current which is equal to the photocurrent. We know the equation for the diode current is:

$$I_d = I_o \exp((V + IR_s)/nV_t) \quad (4.3)$$

Where I_o is the reverse saturation current, R_s is the series resistance and V_t is the thermal voltage and this was been calculated by the formula:

$$V_t = kT/q \quad (4.4)$$

Where, k = Boltzmann constant,

T = temperature in Kelvin,

q = Charge of an electron,

Using the equations (4.1), (4.2) and (4.3) we finally derive the main equation for the load current, I.

$$I = I_{sc} - I_o \exp((V + IR_s)/nV_t) \quad (4.5)$$

The experiment was conducted at no load condition; no current flows through the circuit, so we get the open circuit voltage, and when shorted we get the short circuit current, provided I=0, then equation (5) can be rewrite as:

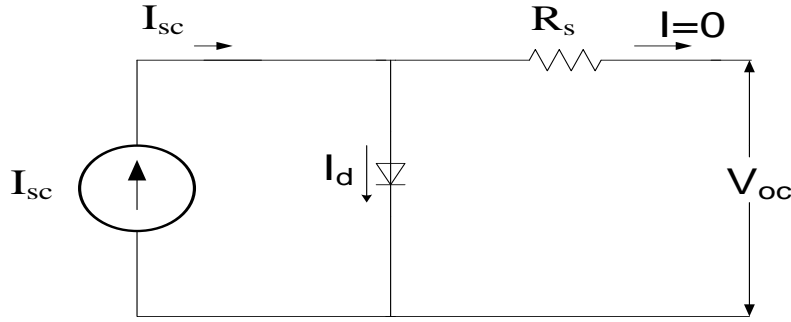

Figure-4.2: Simplified Equivalent Circuit Model for a Photovoltaic Cell connected without any load.

$$I_{sc} = I_o \exp(V_{oc}/nV_t) \quad (4.6)$$

The reverse saturation current is kept constant by keeping the surface temperature of the panel constant and varied the illumination. So for different illumination we can rewrite equation (6) as:

$$I_{sc1} = I_o \exp\left(\frac{V_{oc1}}{nV_t}\right) \quad (4.7)$$

$$I_{sc2} = I_o \exp\left(\frac{V_{oc2}}{nV_t}\right) \quad (4.8)$$

Then by dividing equation (4.7) by equation (4.8), we get :

$$\frac{I_{sc1}}{I_{sc2}} = \frac{\exp\left(\frac{V_{oc1}}{nV_t}\right)}{\exp(V_{oc2}/nV_t)} \quad (4.9)$$

From this relation the equation for n becomes

$$n = (V_{oc1} - V_{oc2})/V_t \ln(I_{sc1}/I_{sc2}) \quad (4.10)$$

Using this equation we get the value of ideality factor for the whole 20W solar panel, so to get the value of n for one cell we need to divide the n of the whole panel by number of cells in the solar panel, N_S . Hence, the equation for one cell:

$$n = (V_{oc1} - V_{oc2}) / (N_S V_t \ln(I_{sc1} / I_{sc2})) \quad (4.11)$$

4.3.2 Experimental Analysis for calculating ideality factor (n):

4.3.2.1 Block Diagram of the experiment:

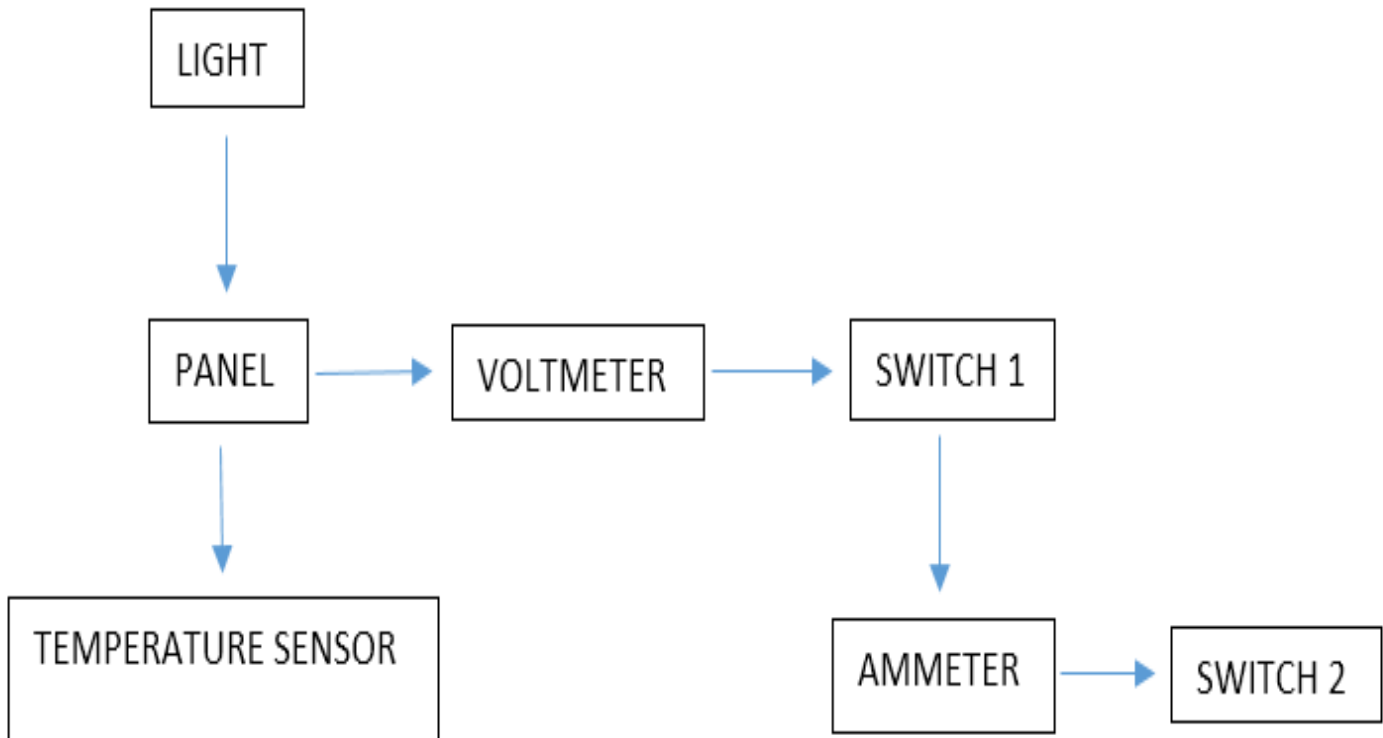

Figure-4.3- Block Diagram of the experiment set up.

4.3.2.2 Description of the experimental process:

The indoor experimental setup was an insulated box within which eight 200 W bulbs were set so that we could change the illumination inside the box. We recorded two sets of data at first keeping eight bulbs turned on, and recorded the first set of data of I_{sc1} , V_{oc1} and then by changing the illumination with four bulbs turned on, we recorded the second set of data of I_{sc2} , V_{oc2} then using the above equation for one cell, we calculated the experimental value for

n. The motive of turning on eight bulbs first, was to keep the temperature of the solar module constant, if we turn on four bulbs first, then it will keep on rising its temperature with eight bulb on. But when eight bulbs is turned on at first, and we turn off the four bulb, the temperature of the panel will not rise much quickly, and we can collect the two sets of data at the same temperature.

4.3.2.3 Conditions for experimental calculation of n:

The experiment was conducted keeping the temperature constant and varying the illumination.

As there was no change in temperature so the reverse saturation current I_o is constant through out the experimental process. The equation used to calculate the reverse saturation is:

$$I_{o1} = \frac{I_{sc}}{\exp((qV_{oc})/nkT_o)} \quad (4.12)$$

Thus using the reference reverse saturation current, we calculate the new reverse saturation current, I_o . The equation used for this calculation is:

$$I_{o2} = I_{o1} \left(\frac{T_i}{T_o} \right)^3 \exp\left(\frac{-E_g}{k/q} * \left(\frac{1}{T_i} - \frac{1}{T_o}\right)\right) \quad (4.13)$$

Where,

I_{o1} = reverse saturation current, at temperature, T_o

I_{sc} = Short circuit current

V_{oc} = Open circuit voltage

q = charge of an electron

n = Ideality factor

k = Boltzmann constant

T_o = Temperature at which I_{o1} is taken

E_g = Band gap energy

T_i = New temperature

I_{o2} = New reverse saturation current

We kept T_o and T_i equal so thus we found that the reverse saturation currents I_{o1} and I_{o2} equal so there was no effect of reverse saturation currents and we could cancel out the reverse saturation currents.

The reference equation, which is used to calculate the relation between I_{sc1} and I_{sc2} varying the illumination is given below

$$I_{sc2} = I_{sc1} \left(\frac{l_2}{l_1} \right) \quad (4.14)$$

The illumination is not same i.e. $l_2 \neq l_1$

So the short circuit currents are not equal i.e. $I_{sc1} \neq I_{sc2}$

Thus using this relation ideality factor is calculated.

4.3.2.4 Result and Analysis of the experimental value of n:

By putting the values of V_{oc1} , V_{oc2} , I_{sc1} and I_{sc2} that are obtained by carrying out the experiment in the equation below we calculate the ideality factor, n for one cell. The number of cells in mono-crystalline solar panels we are experimenting which has 36 cells, i.e. $N_s=36$, $V_t=25.7025\text{mV}$

Theoretically for mono crystalline the value of (n) is 1 but experimentally we found the value of (n) to be 1.25; and the value of n must be within 1 to 1.5 for polycrystalline, according to the theory, but we obtained $n=1.71$ from our experimental data. Theoretical analysis will vary from practical analysis. This is because there is some error while doing the experiment. We can say that our result is very close to theoretical analysis. When we short-circuited the panel than the voltage was not exactly zero as there may be some resistance of the wire.

$$n = (V_{oc1} - V_{oc2}) / N_s V_t \ln(I_{sc1} / I_{sc2})$$

The values obtained for mono-crystalline panel are

$$V_{oc1} = 20.5 I_{sc1} = 0.4 \text{ mA}$$

$$V_{oc2} = 19.7 I_{sc2} = 0.2 \text{ mA}$$

Putting these values and the value of V_t and $N_s=36$

We get $n=1.25$.

The values obtained for poly-crystalline panel are:

$$V_{oc1}=20.3I_{sc1}= 0.42 \text{ mA}$$

$$V_{oc2}=19.2I_{sc2}= 0.21 \text{ mA}$$

We get $n=1.71$.

4.4 Obtaining the I-V sweep curve of the solar module for different temperature:

4.4.1 Theoretical Analysis for plotting I-V sweep curves of a solar module:

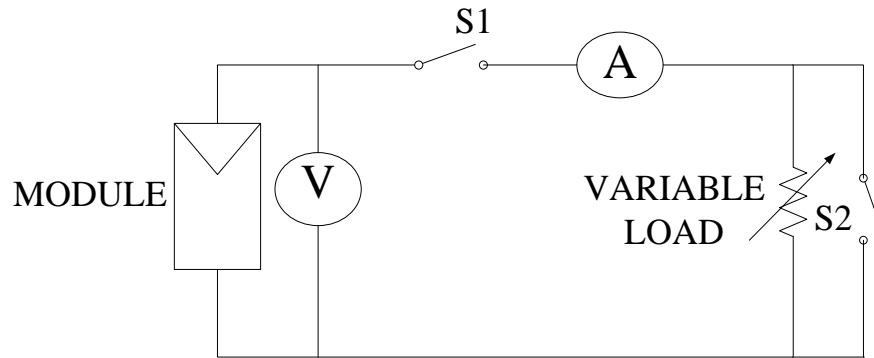

Figure: 4.4 - a solar module is connected with a variable load and meters via switch.

With this circuit we are analyzing the I–V characteristics of the solar panel at different temperature. To plot the I-V curve, we need a set of data of both current and voltages and varying the resistance of the load does this and respectively and we have I-V graph at different temperature.

4.4.2 Experimental Analysis for plotting I-V sweep curves of a solar module:

4.4.2.1 Description and conditions of the experimental procedure:

The experiment was carried out indoor where we used a wooden box with eight bulbs, 200 W each. At first we carried out the experiment from 25°C with the box open until the temperature was 60°C. After 60°C the temperature does not rise as rapidly as it did from 25°C to 60°C, for this reason we insulated the panel with a foam in order for the temperature to rise from 60°C to 80°C with the box open. After 80°C we closed the box and recorded the data until the temperature was 100°C.

Many I-V curves was obtained with an interval of 5°C starting from 25°C to 100°C, during this time temperature at each 5°C interval was kept constant. We used a variable load with a resistance of 150Ω. We varied the resistance from 150Ω to 0Ω. When we measured the short

circuit current (I_{SC}) the both S1 and S2 was kept closed and when measuring the open circuit voltage (V_{OC}) both S1 and S2 was open. The I_{SC} and V_{OC} found was not accurate as the switches were not ideal and the wires had voltage drop in them.

For determining the current (I) and voltage (V) of the panel to determine I-V characteristics switch S1 was closed and S2 was open. We tried to do the experiment as accurate as possible with a very small fluctuation of temperature and nearly keeping the temperature as constant as possible as we need to carry out the experiment at different temperature. The readings must be recorded as fast as possible, because the temperature of the panel changes very rapidly. To keep the temperature constant we put a fan in the hole of the box and put on the AC so that we can control the temperature. To make it more accurate we are going to do the analysis with the help of microcontroller.

In order to obtain the I-V sweep curves at different temperature we kept the illumination constant. All the eight lights were turned on and waited for few minutes for the illumination to stabilize. We also kept the temperature constant and took the readings for different temperature. In order to do this we varied the load applied for each and every curve obtained at different temperature level.

4.4.2.2 Block diagram of the experimental setup for getting I-V sweep curves:

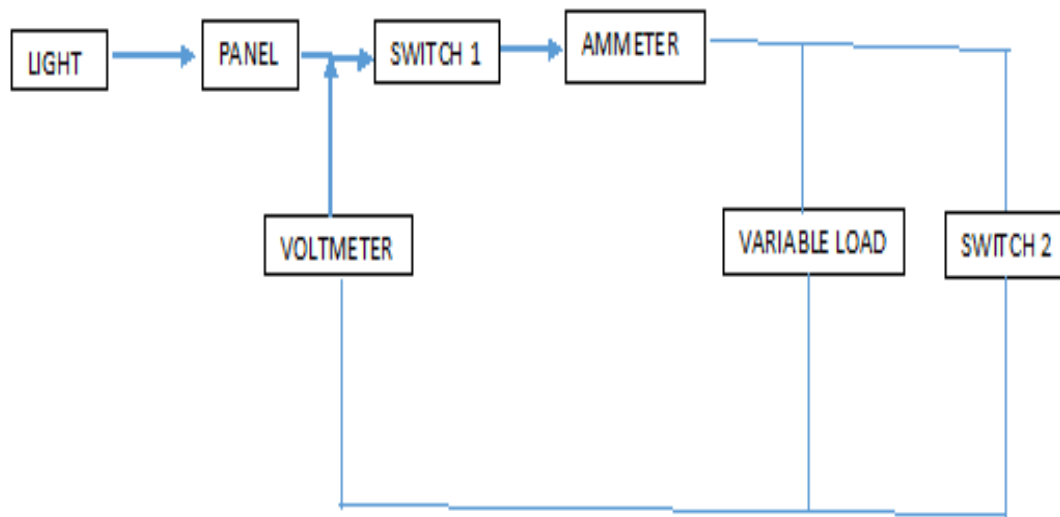

Figure-4.5: Block diagram of the experimental set up.

4.5 Results and Analysis:

4.5.1 I-V sweep curves at different temperatures:

We obtained sixteen set of data of voltages and currents, at sixteen different temperatures, we used Matlab to plot the data, and the curves attained for 36 mono-crystalline Silicon cells are given below. As we can see that the short circuit current rises where as the open circuit voltage decreases with the increasing temperature. The I_{sc} varied from 0.41- 0.4847 A, whereas the V_{oc} varies from 20.6-15.4 V, the results are quiet close to our theoretical analysis. We can also take out many other parameters from this set of I-V sweep curves, that is how the P_{max} , FF, I_{mp} , V_{mp} are varying with the temperature, are going to discuss about each of the curves plotted against temperature.

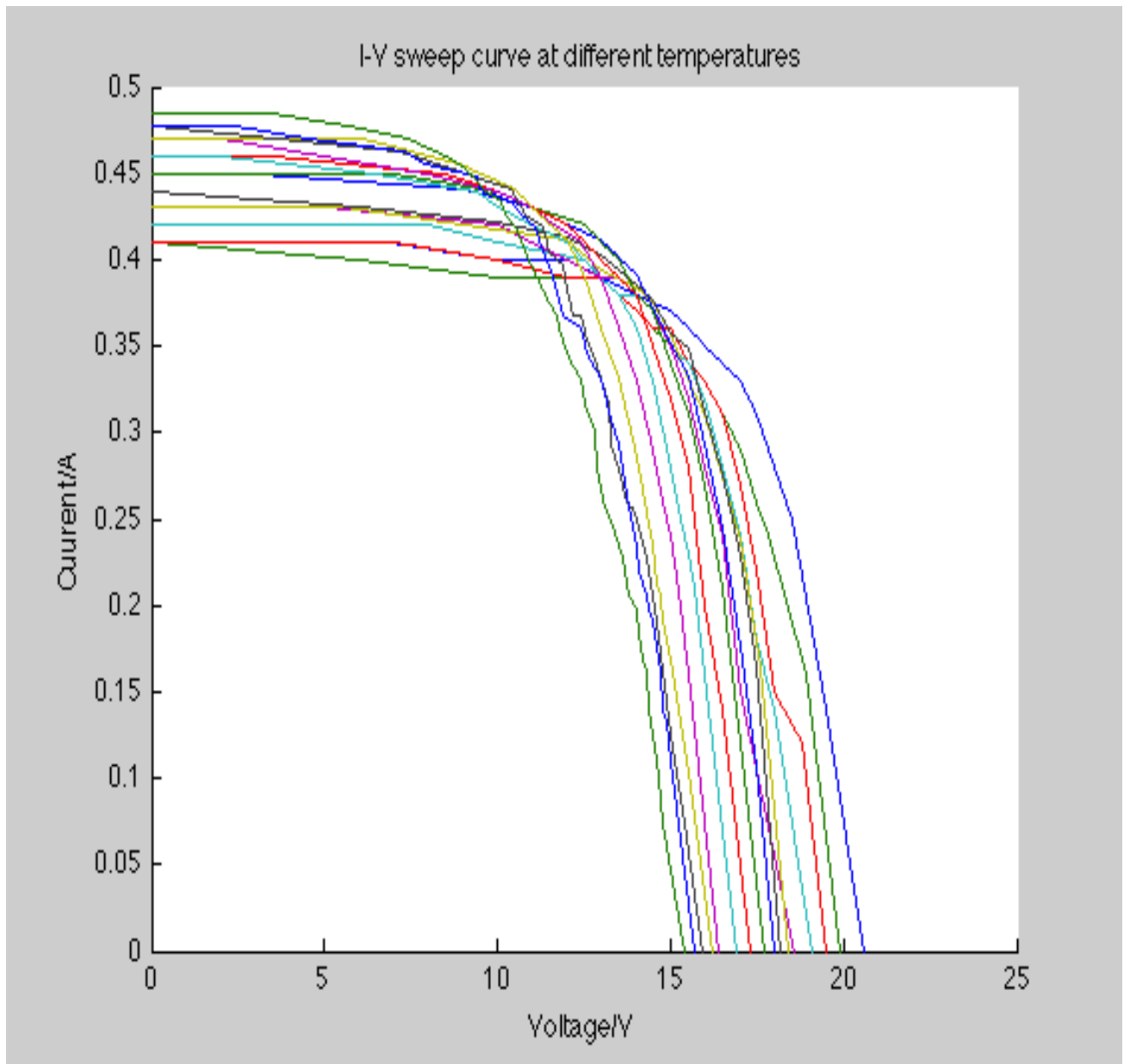

Figure-4.6: I-V sweep curve at different temperatures of Mono-crystalline Silicon module(36 cells)

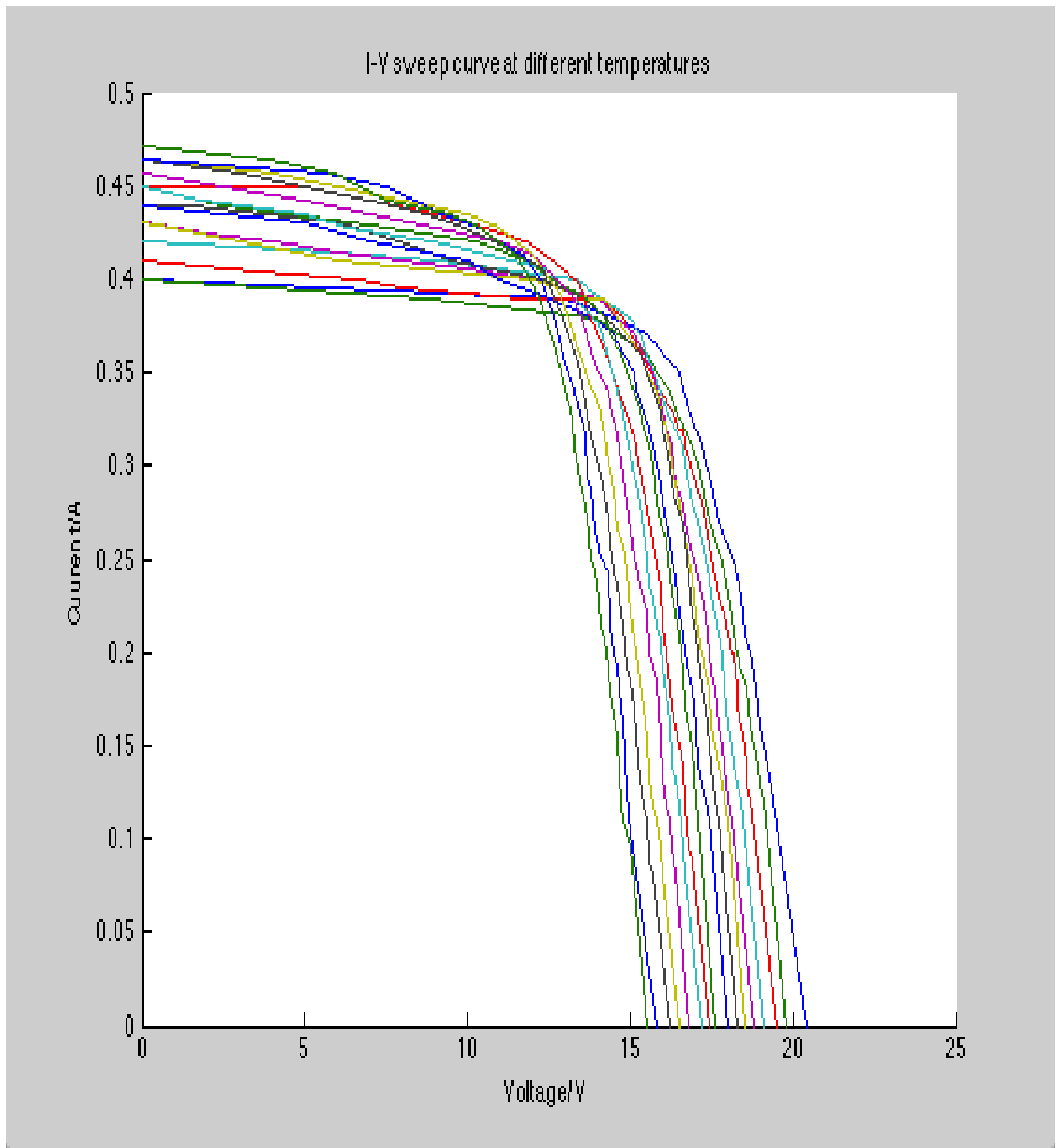

Figure-4.7: I-V sweep curve at different temperatures of Poly-crystalline Silicon module (36 cells)

4.5.2 Effect of temperature on short circuit current:

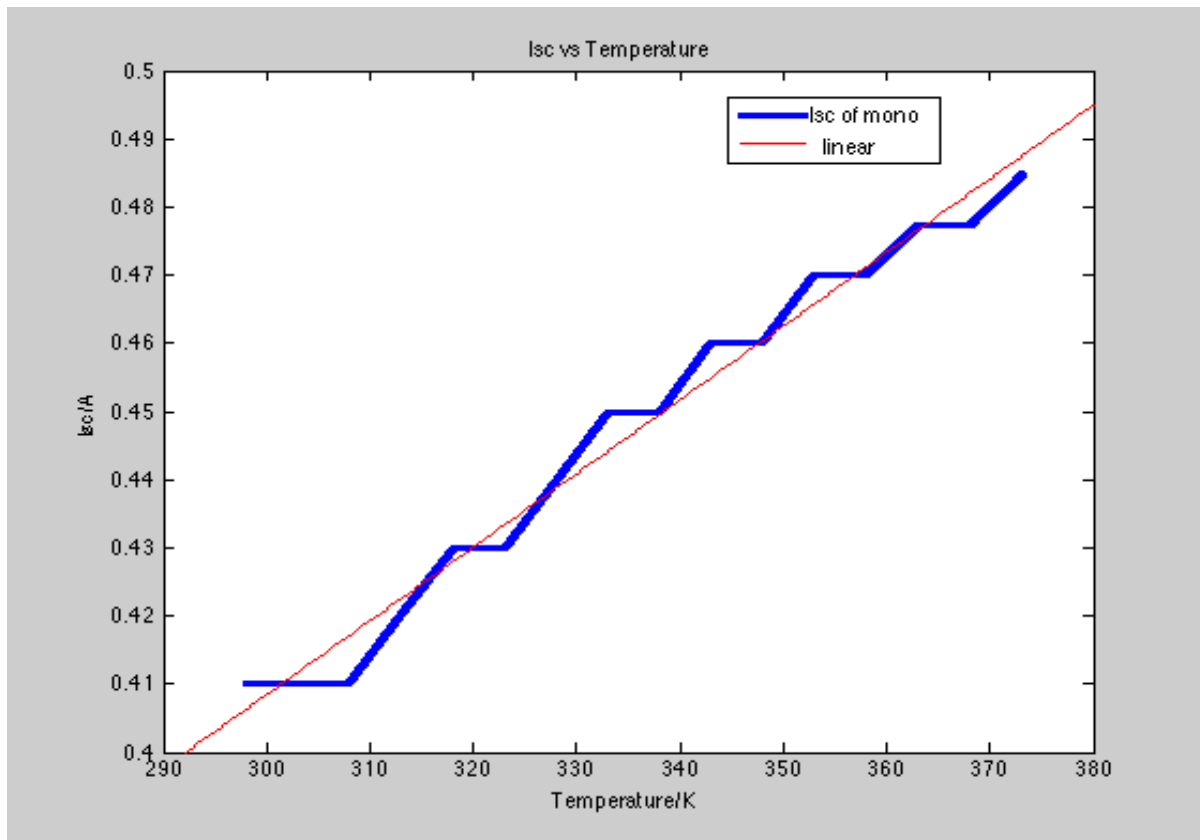

Figure-4.8: Variation of short circuit current of Mono-crystalline Silicon module with temperature.

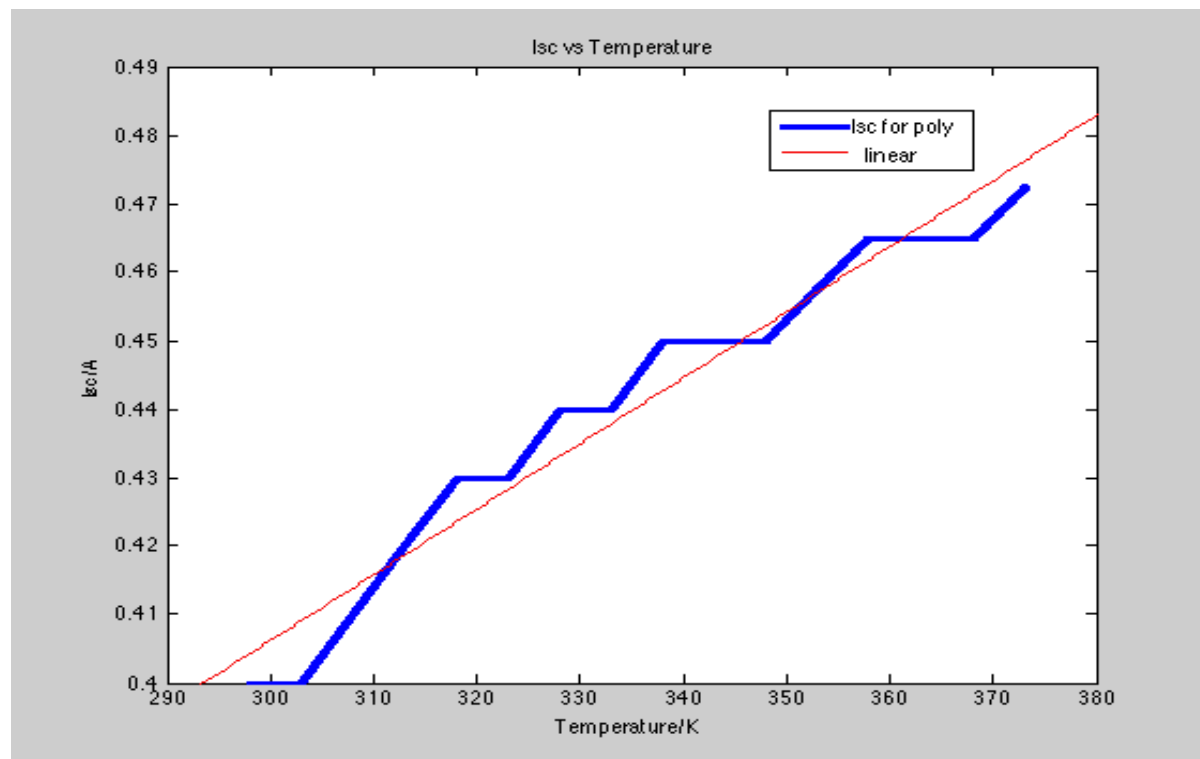

Figure-4.9: Variation of short circuit current of Poly-crystalline Silicon module with temperature.

The curve shows I_{SC} raises with the increase in temperature but due to error in the data the curve is not proper but it still shows the increasing trend. When we did linear fitting than the equation of the curve is $I_{SC}=0.0011*T+0.084$ for the mono crystalline panel, so the temperature coefficient is 1.1mA/K of the I_{sc} of the Mono-crystalline Silicon module. The equation of the curve is $I_{SC} = 0.00096*T+0.12$ for mono crystalline solar cell and the temperature coefficient is 0.096mA/K.

4.5.3 Effect of Temperature on Open circuit voltage:

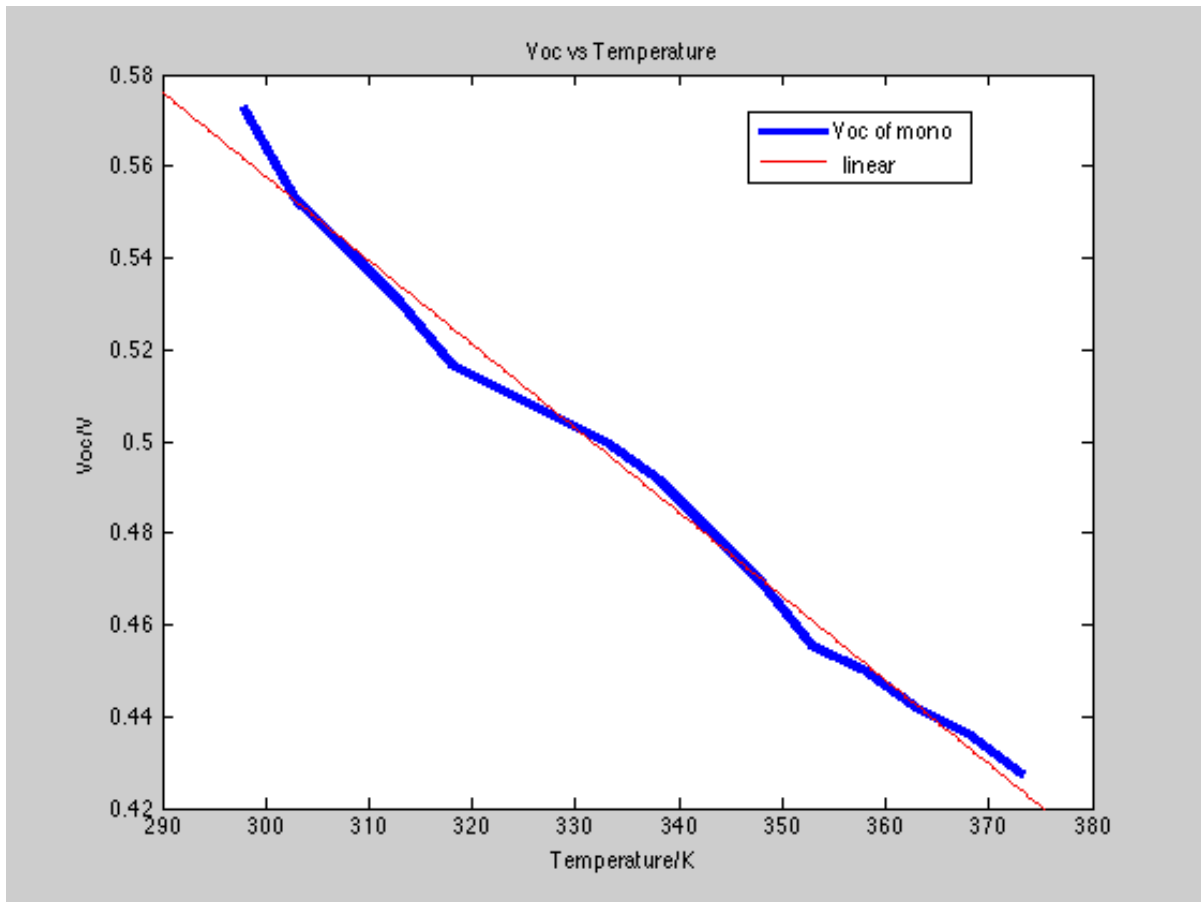

Figure-4.10: Variation of open circuit voltage of Mono-crystalline Silicon module with temperature.

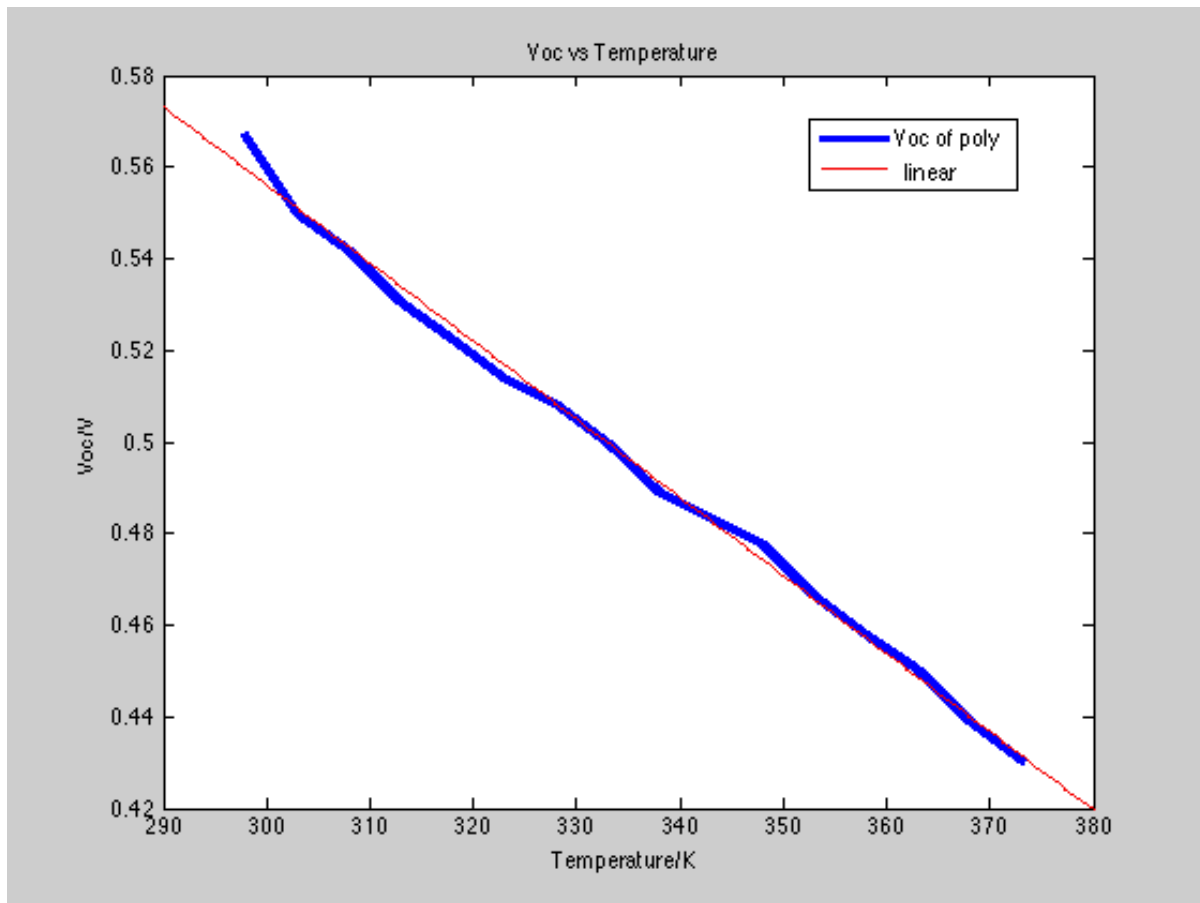

Figure-4.11:Variation of open circuit voltage of Poly-crystalline Silicon module with temperature.

The curve shows that the V_{oc} decreases with the temperature, but due to some experimental errors it does not fully follow a linear path, for that reason we used the basic fitting tool in Matlab, and got the relation of V_{oc} and temperature as follows:

$$V_{OC} = -0.0018 * T + 1.1 \text{ (for one cell)}$$

So the temperature coefficient is -1.8 mV/K of the V_{OC} for Mono-crystalline Silicon module (1cell), which is quiet close to the theoretical value, which -2 mV/K .

The V_{OC} for poly crystalline is

$$V_{OC} = -0.0017 * T + 1.1 \text{ (for on cell)}$$

The temperature coefficient -1.7 mV/K for poly crystalline silicon solar cell (1 cell) which goes to show that it is quite close to the theoretical data.

4.5.4 Effect of Temperature on maximum power point- P_{max} :

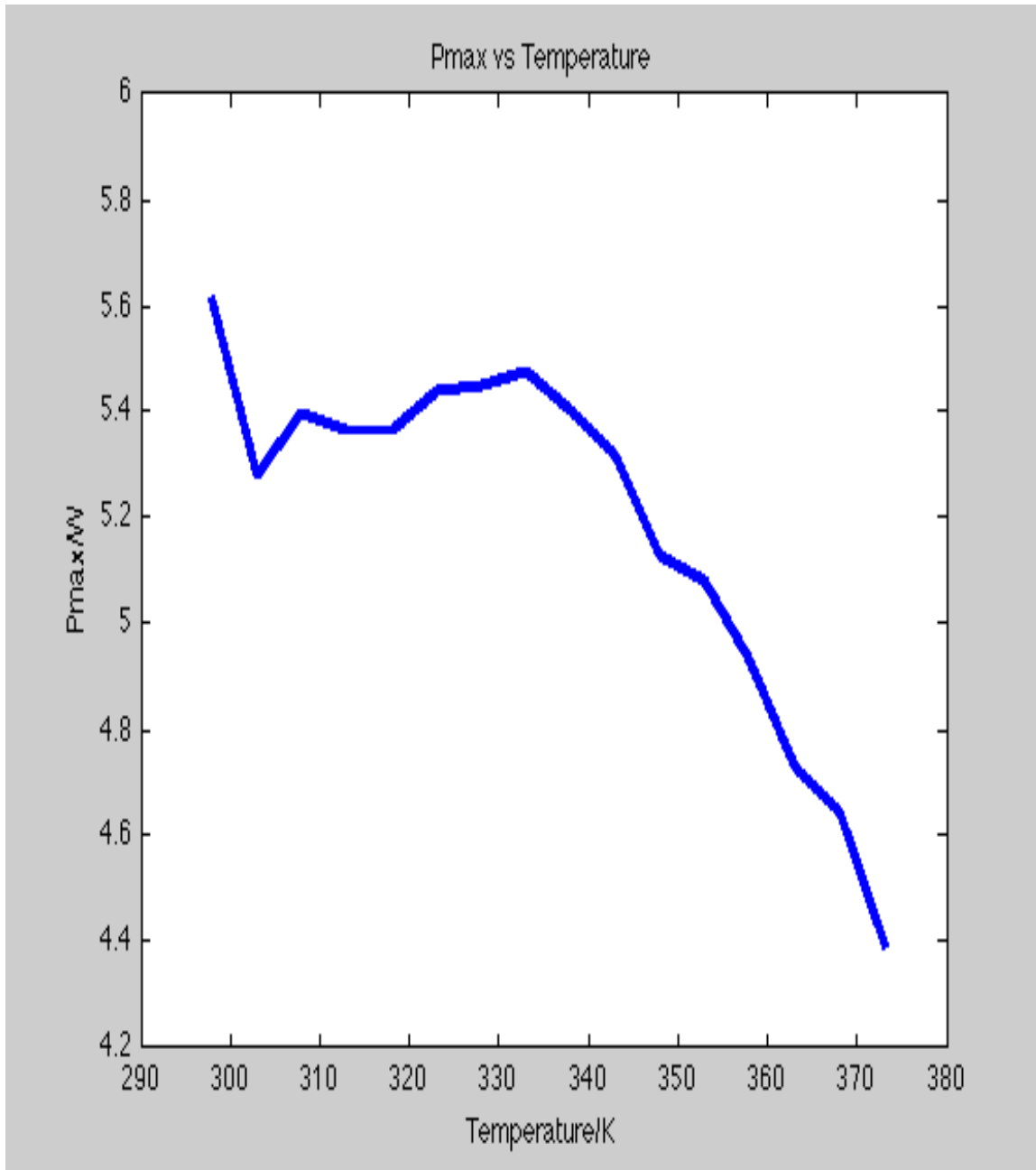

Figure-4.12: Variation of P_{max} of the Mono-crystalline Silicon module(36cells) with temperature.

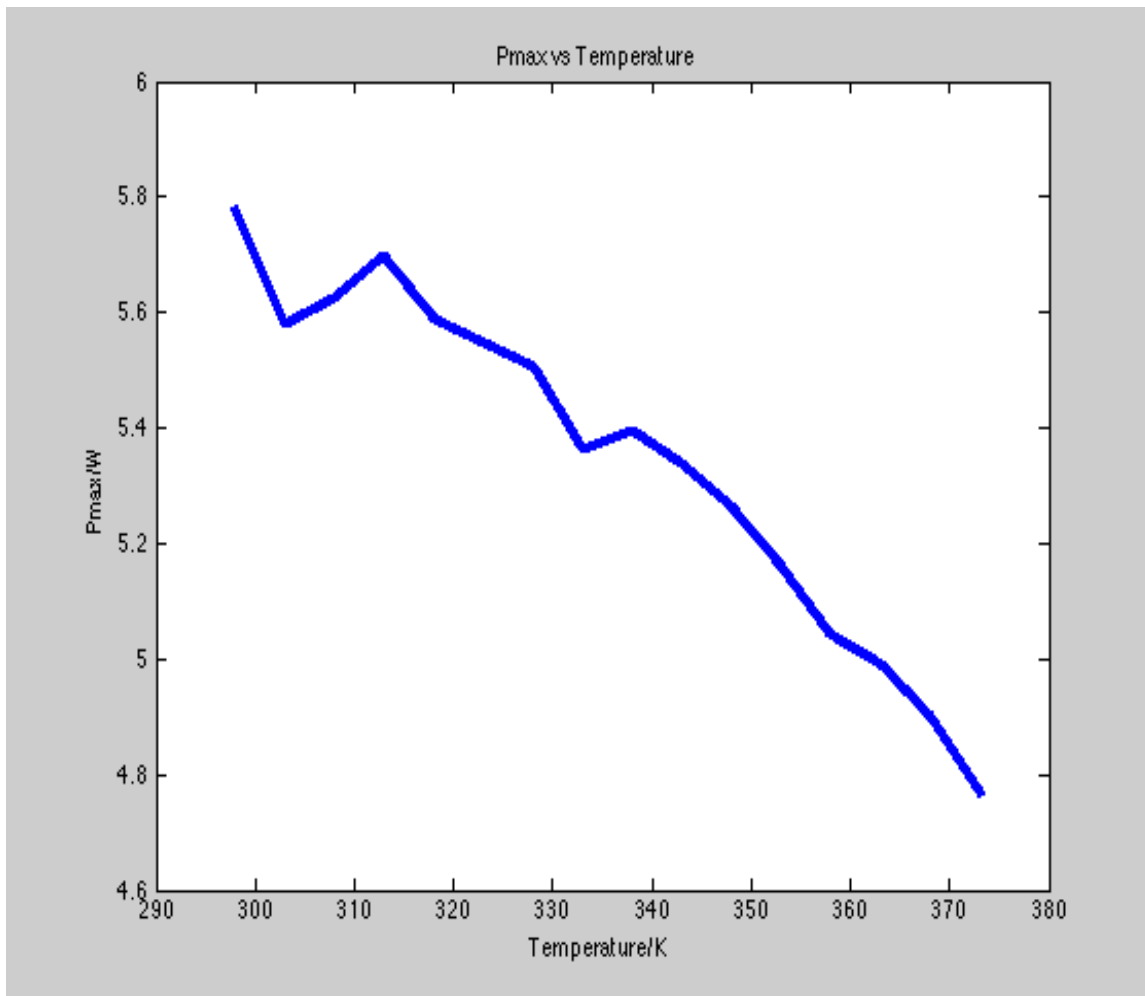

Figure-4.13: Variation of P_{\max} of the Poly-crystalline Silicon module(36cells) with temperature.

The curve shows that the P_{\max} decreases with the increase in Temperature. We calculated the power by multiplying a set of voltage with current by the help of the Matlab, and also took out the maximum power from the array by the built in function max in Matlab.

The curve should be in the decreasing order, as the decrease in voltage is greater than the increase in current, but there is no uniformity in the curve as it rises high and then rises low again, we need to do some basic fitting with the raw data for obtaining an exact equation for P_{\max} depending on temperature.

4.5.5 Effect of temperature on FF:

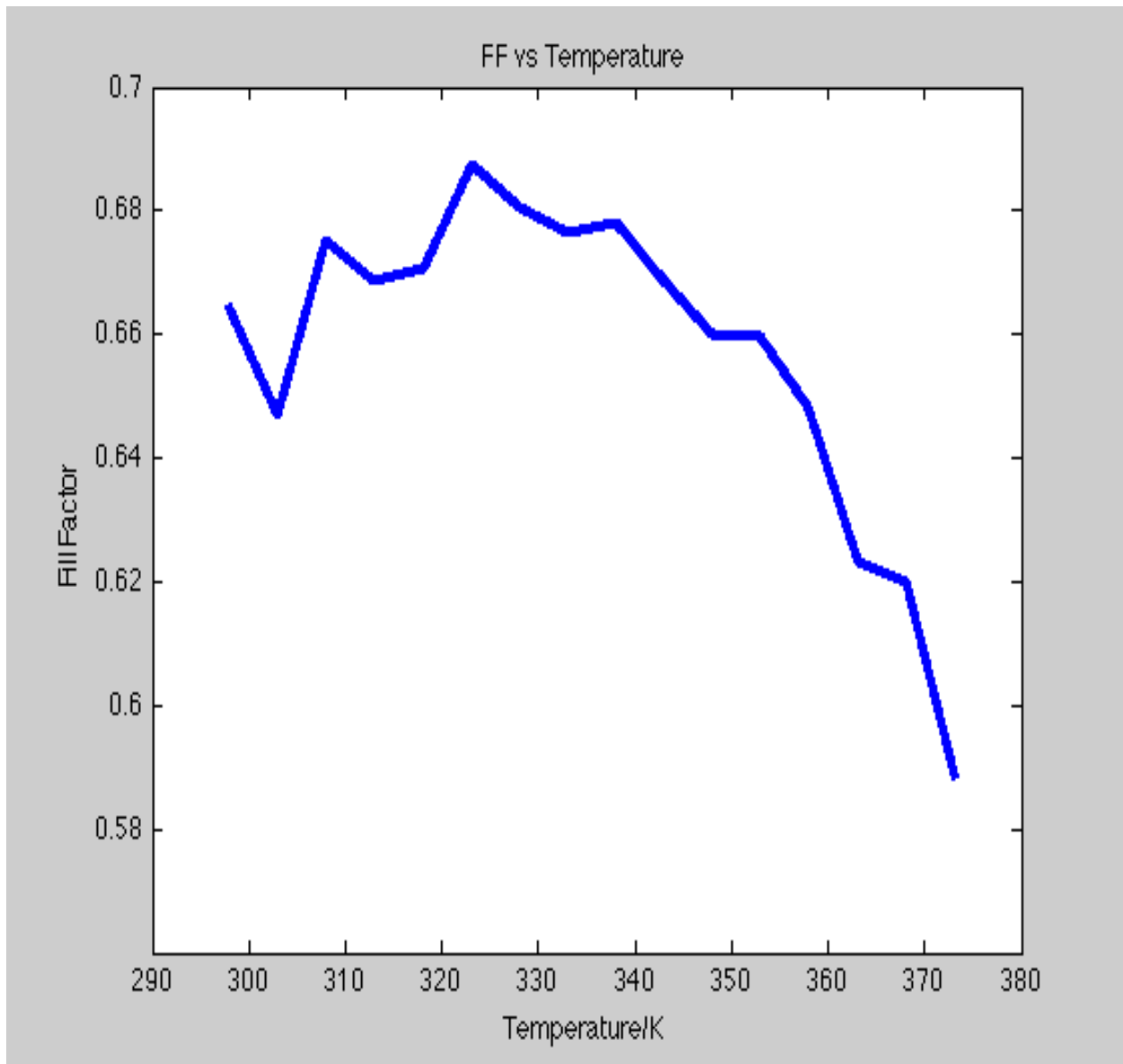

Figure-4.14: Variation of Fill Factor of Mono-crystalline Silicon module with temperature.

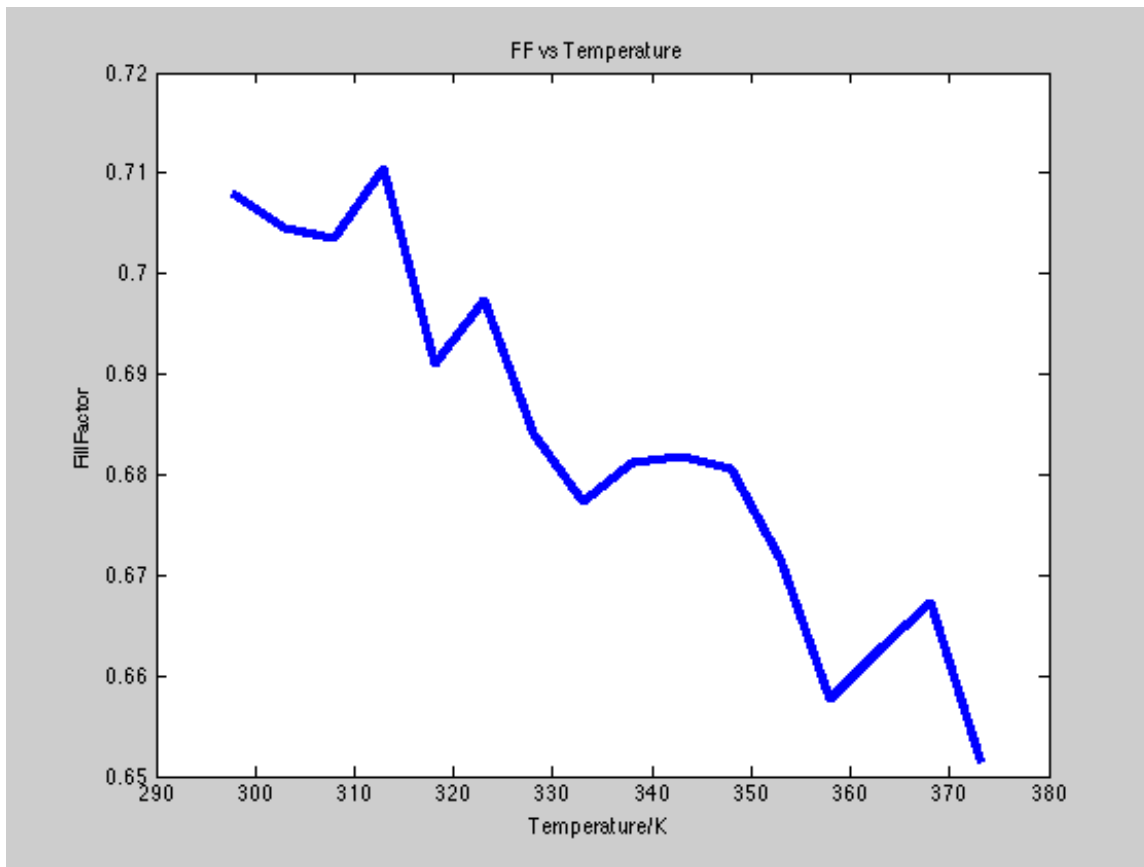

Figure-4.15: Variation of Fill Factor of Poly-crystalline Silicon module with temperature.

The FF is defined as the ratio of the maximum power from the solar cell to the product of V_{oc} and I_{sc} .

$$FF = \frac{P_{max}}{V_{OC} * I_{SC}}$$

The P_{max} decreases with the increasing temperature hence the rate at which the V_{oc} decreases the I_{sc} does not increase in that rate so we can deduce that the FF vs Temperature curve will be like the P_{max} curve. The I_{sc} increases at a rate of 1.1mA/K whereas the V_{oc} decreases at a rate of 1.8mV/°K. So the increasing rate of current is less than the decreasing rate of voltage.

Similarly, the I_{sc} for poly crystalline cell is increasing at a rate of 0.96mA/K and the V_{oc} is decreasing at a rate of 1.7mV/. In this case also the decreasing rate current is less than the decreasing rate of voltage. So the FF vs Temperature curve is like the shape of the P_{max} vs Temperature curve.

4.6 Analyzing the effect of temperature on series resistance (R_s) of the Silicon solar module:

4.6.1 Theoretical analysis for calculation of R_s :

From the set of I-V curve one curve is taken for calculating the R_s . This is done by taking the maximum power point of that curve and correspondingly taking distinct separate point in that maximum power point area, where we will find two separate voltages and two separate current on that curve.

The equation for the R_s is as follows

$$I_1 = I_{SC} - I_o \exp((qV_1 + qI_1R_s) / nKT) \quad (4.15)$$

$$I_2 = I_{SC} - I_o \exp((qV_2 + qI_2R_s) / nKT) \quad (4.16)$$

From (4.15) and (4.16) we get

$$\ln((I_{SC} - I_1) / I_o) = (V_1 + I_1R_s) / (KT/q)$$

$$R_s = \left[\frac{KT V_1}{q} - \frac{KT}{q} \ln(I_{SC} - I_1) \right] * 1 / I_1 \quad (4.17)$$

Combining (4.15) and (4.16) we get.....

$$R_s = \left[\frac{V_1 - V_2}{N_s} - \frac{nKT}{q} \ln \left(\frac{I_{SC} - I_1}{I_{SC} - I_2} \right) \right] * \frac{1}{I_1 - I_2} \quad (4.18).$$

We use the equation(4.18), to calculate the series resistance of the Silicon solar module.

4.6.2 Experimental procedure for calculating R_s :

The solar panel can be modeled as:

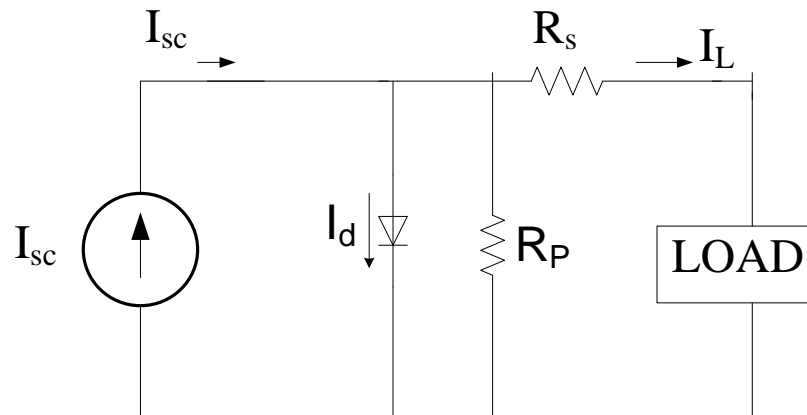

Figure-4.16: Simplified equivalent circuit model of a Silicon solar cell connected with a load

The R_p can be neglected, as the parallel resistance is very high, than the circuit looks like the circuit below

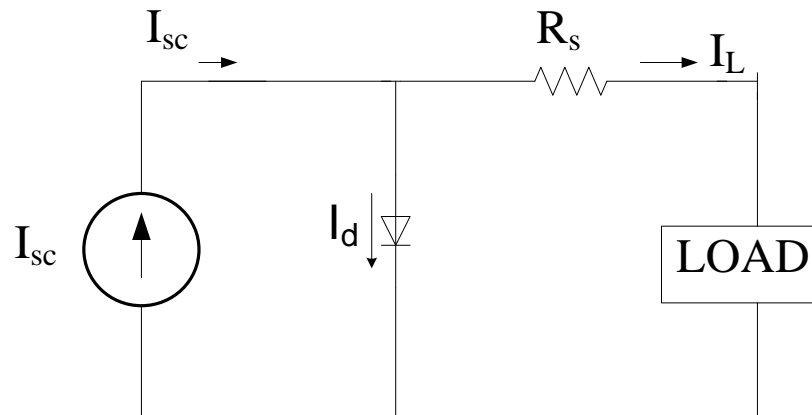

Figure-4.17: Simplified equivalent circuit model of a Silicon solar cell connected with a load, ignoring the shunt resistance.

The R_s can be found in two ways i.e. from the data and from the I-V curve by taking two points in the maximum power point area.

4.6.3 Conditions for calculating R_s :

The illumination of the panel was kept constant and we tried to keep the temperature constant for a single I-V curve. We achieved this by cooling the room with the AC and putting a fan in the box so that the temperature remains constant and that it does not fluctuate much.

4.6.4 Block diagram of the experiment for calculating R_s :

We use the same experimental set up, from which we obtained the I-V sweep curve, and that is as follows:

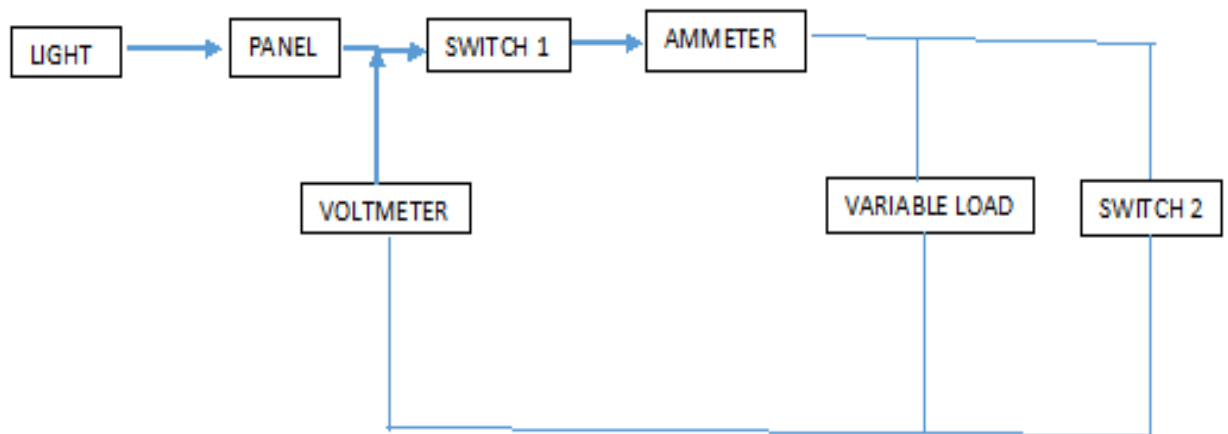

Figure-4.18: Block diagram of the experimental set up.

4.6.5 Results and Analysis:

Rs from I-V sweep curve at different temperatures:

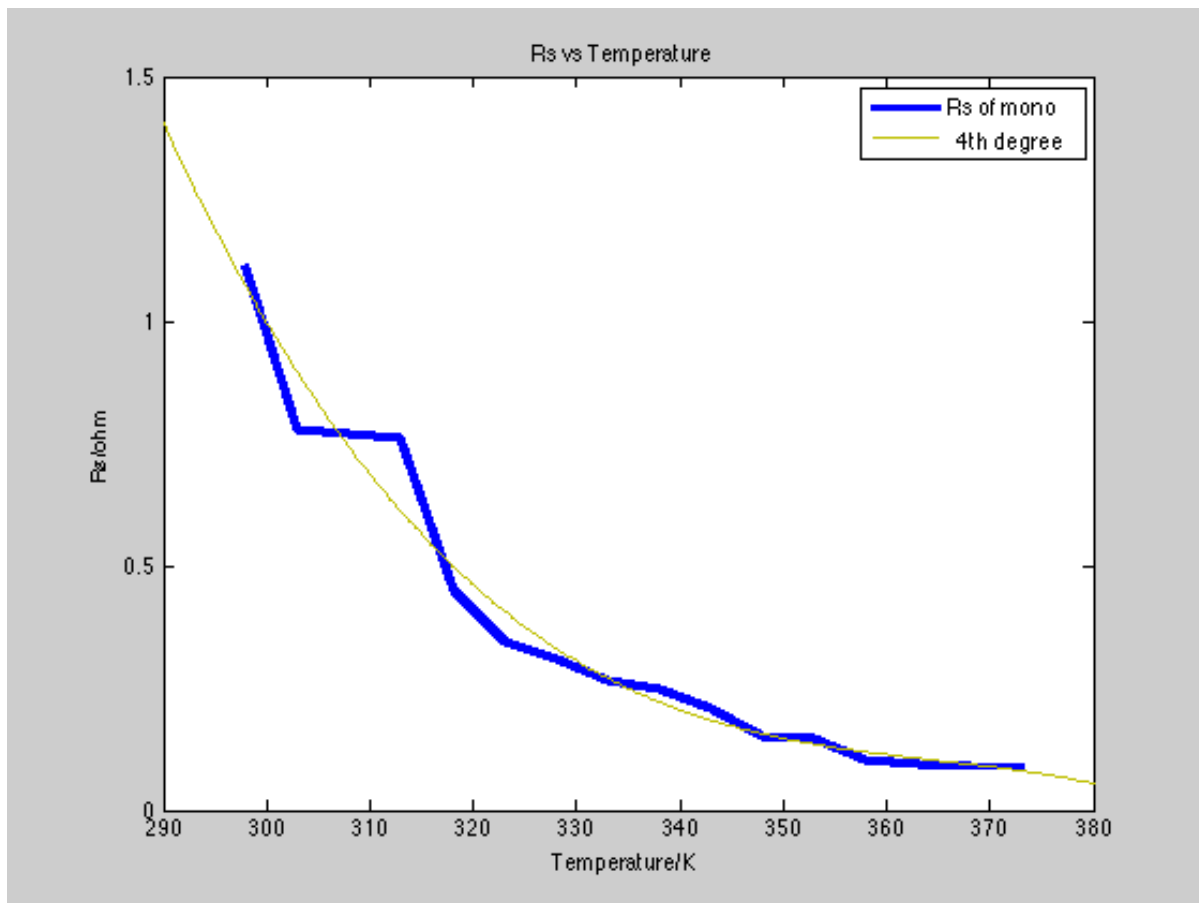

Figure-4.19: Variation of Rs of Mono-crystalline Silicon solar module with temperature.

The curve is the relationship between Temperature and R_S . The curve shows there is falling trend of R_S with the increase in temperature but there are lots of bumps, which shows that there was error in reading as the readings was taken manually. Here, we are showing the plot with the raw data obtained during the experiment, but we need to fit the data with the basic fitting tools of the MATLABSo,

We then best fitted the data and the equations we got are given below

Equation for mono-crystalline:

$$R = -3.4e^{-9}T^4 + 2e^{-6} + 0.00052T^2 - 0.52T + 84$$

Equation for polycrystalline:

$$R = -3.9e^{-9}T^5 - 6.8e^{-6} + 0.0047T^3 - 1.6T^2 + 2.8e^2 + 2e^4$$

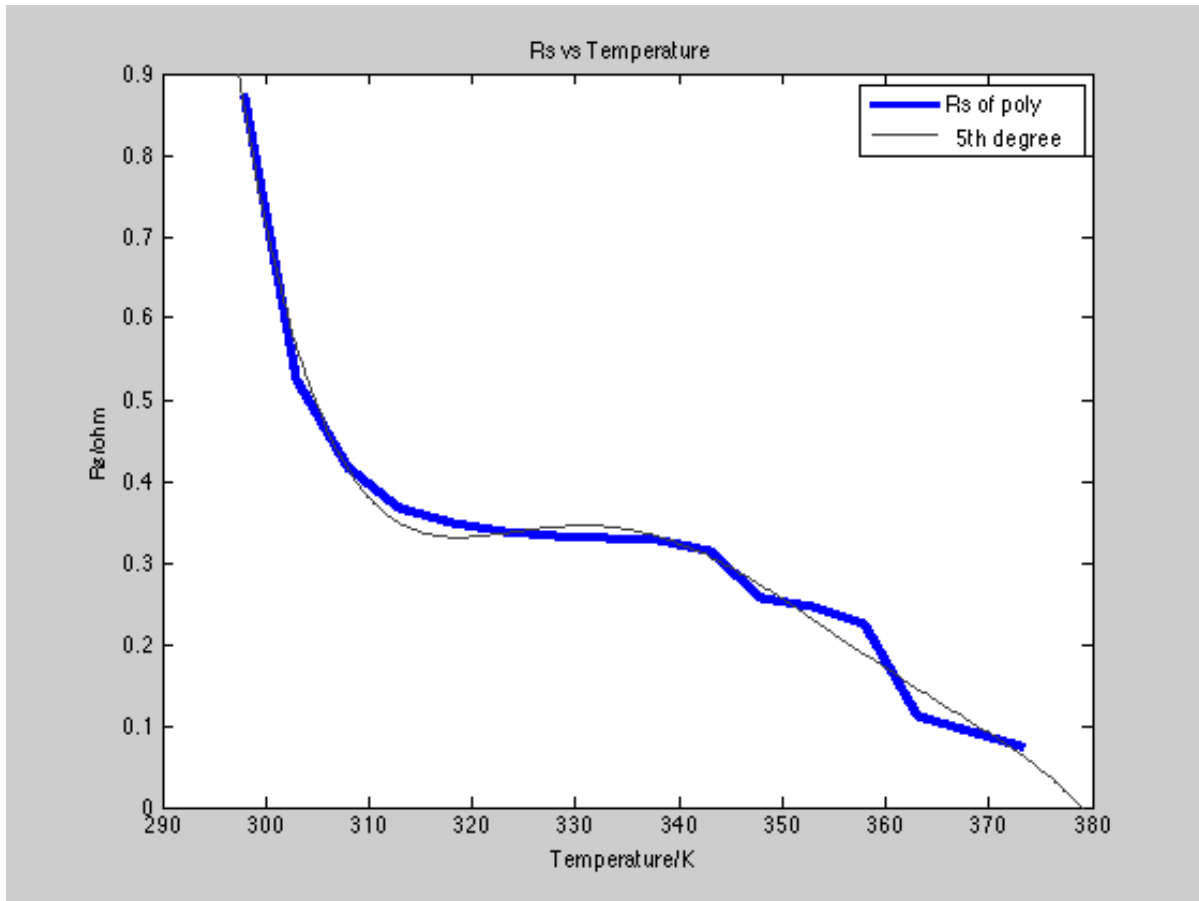

Figure-4.20: Variation of Rsof Poly-crystalline Silicon solar module with temperature.

4.6.6 Conclusion

As far we have seen the results obtained from the experiments done with the Mono-crystalline Silicon module, we are not getting the exact result that is expected from the theoretical study. We need to improve our measurement taking accuracy, and introducing automatic data logger system, by which the reading of the current, voltage, temperature and illumination would be recorded directly for analysis, can do that. We have done all the calculation for only Mono-crystalline Silicon solar module, still we are left with the Amorphous and Poly-crystalline Silicon solar modules; so when we are going to do those experiments, we will be using an AVR microcontroller to store the data.

We were just focusing on the effect of temperature, as there is no equipment available in our country to measure the indoor illumination, so we are trying to build an electronic circuit, which can give us the value of the light illuminated on the module surface.

We are taking out the module parameter values because those will be needed in our theoretical energy calculation, so we cannot skip an important part like measuring the exact illumination on the surface of the module.

After taking out all the parameters, and then if we can in-corporate all necessary data in MATLAB simulation program, we can calculate the amount of energy that can be extracted from the three types of Silicon solar cells, and after getting the theoretical value we can compare with the experimental values obtained, and then compare the difference of energy obtained from two different analysis.

CHAPTER 5

POWER AND ENERGY CALCULATION

5.1 Introduction

We calculated the power that can be extracted over the year from a 20W mono-crystalline solar panel, and a 20W poly-crystalline solar panel. There are number of factors upon which the output of a solar panel is dependent, in our work we have considered only two factors, that is the illumination of the solar radiation and the surface temperature of the panel.

Power is the product of the voltage and its corresponding current flowing in the solar cells, and the current is dependent upon both temperature and illumination, so in order to calculate the current, we need to know the illumination of that particular place and time, and the corresponding surface temperature of the solar cell.

Equations which are used to calculate the solar radiation for Dhaka, is already explained in Chapter-2 of this paper, now here we are explaining how we have calculated the power of a single day in MATLAB, then the energy that can be extracted over the year is calculated by the similar manner.

5.2 Process of Energy calculation:

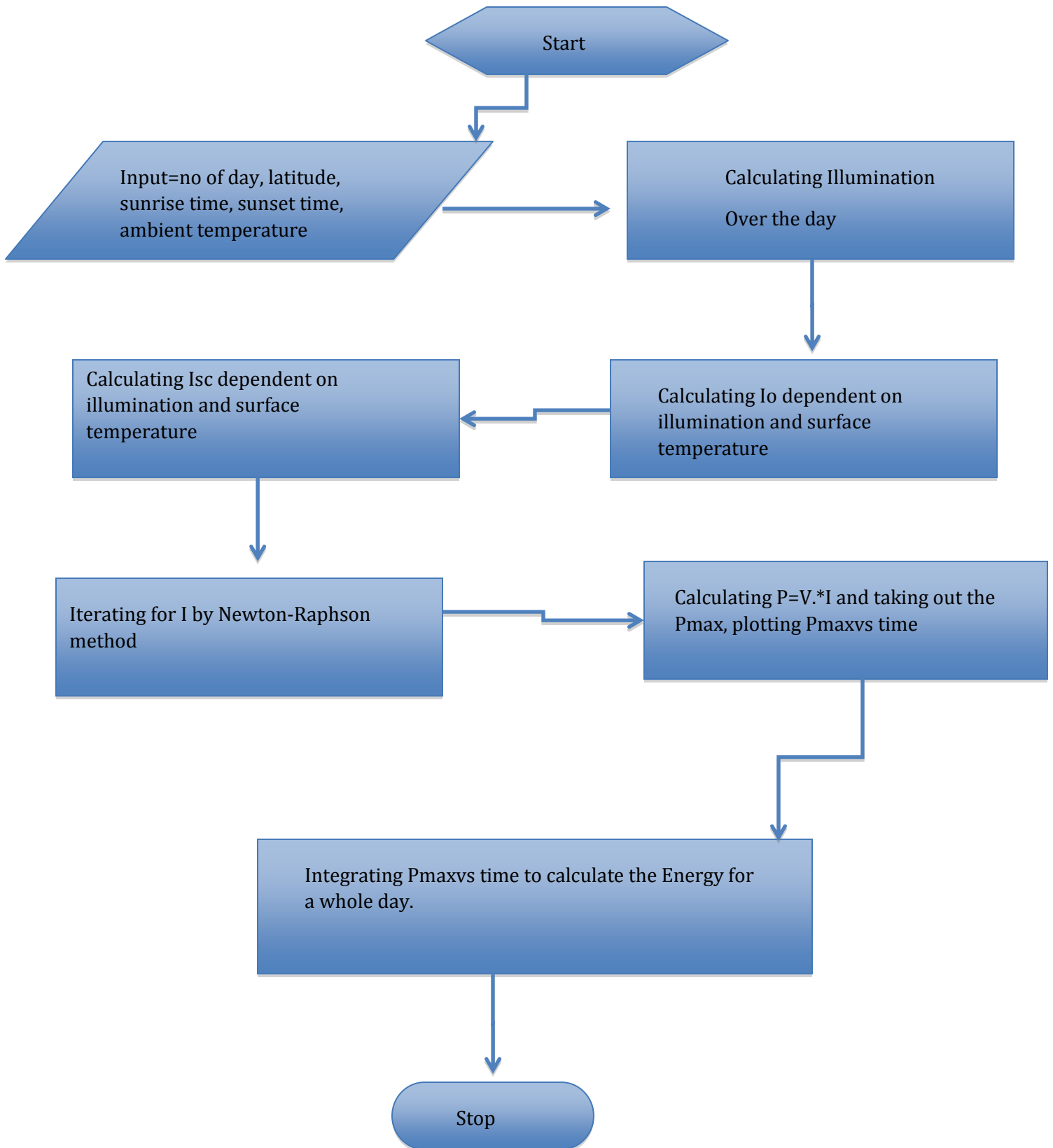

5.3 Graphs of Solar radiation and Temperature over the year:

We have collected the data of ambient temperature for Dhaka city over the year of 2013, and based on that temperature data, solar radiation for each day is calculated by MATLAB simulation.

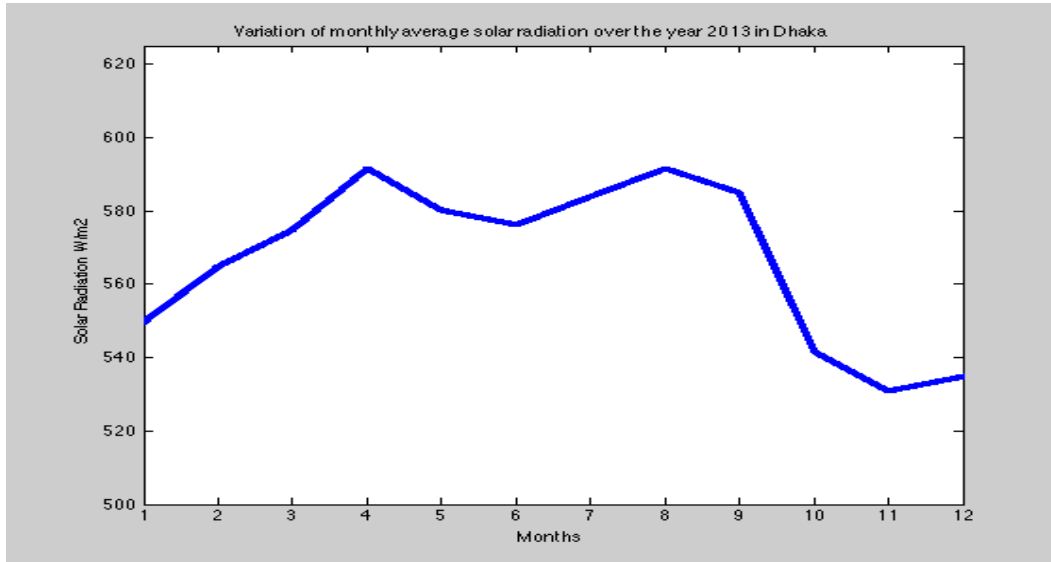

Figure-5.1: The variation of average monthly solar radiation in Dhaka city over the year 2013.

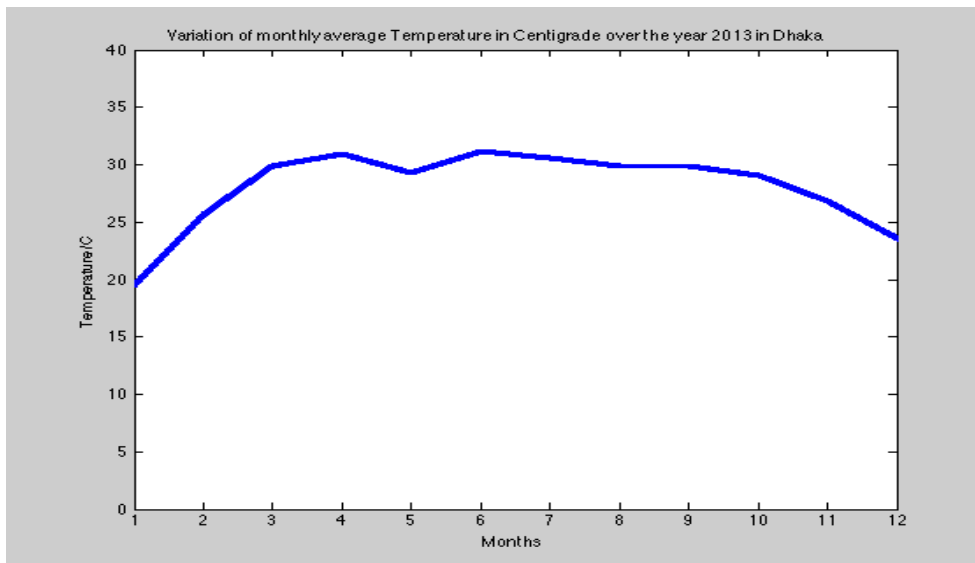

Figure-5.2: The variation of average monthly Temperature of Dhaka city over the year 2013.

The above figures here represent the overall illumination and temperature over one year period of time. Here we have calculated the overall intensity of the year. The intensity was calculated by taking the average intensity of a day and then calculating the average intensity over one month.

The calculation involves the whole day period where there is peak illumination as well as minimum illumination, so to maintain the overall period of calculation we have taken the average illumination and temperature of the day.

5.4 Results and Comparison:

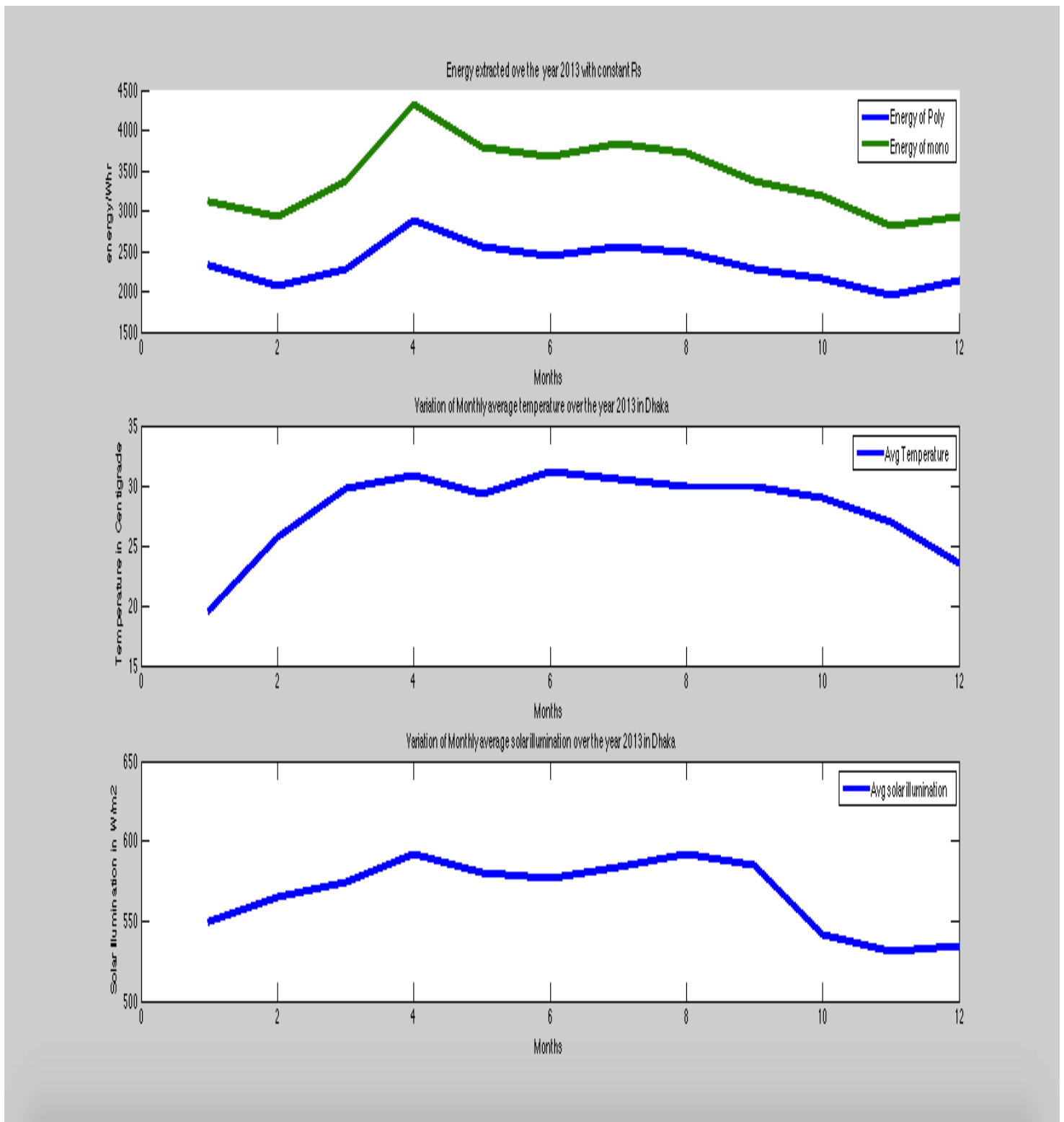

Figure-5.3: Variation of analytical energy with constant Rs with months, over the year of 2013 for Dhaka city.

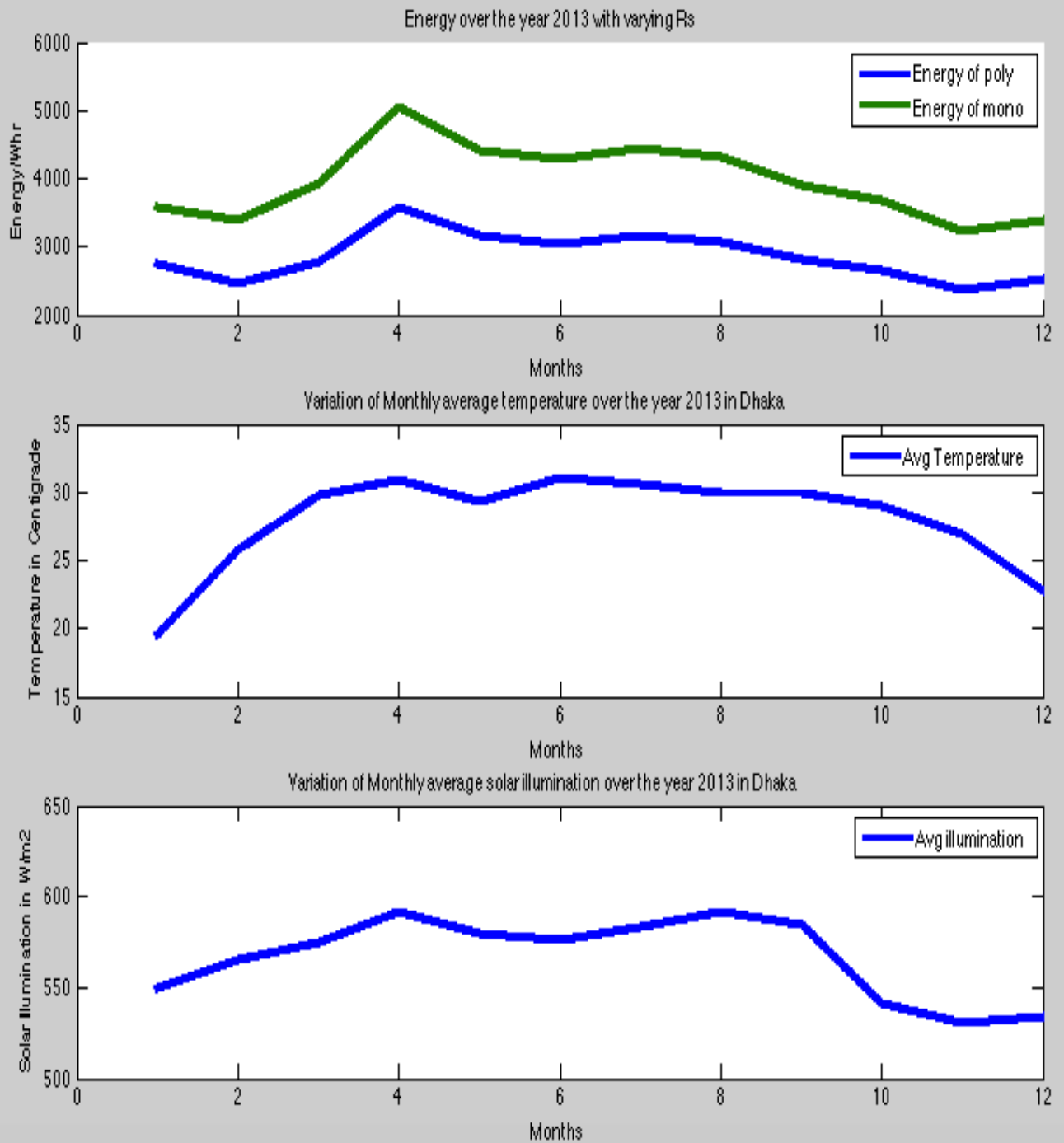

Figure-5.4: Analytical Energy comparison over the year of 2013 with varying Rs, for Dhaka city.

5.4.1 Variation of Energy with respect to Temperature and illumination:

In the above figures, we can see that Energy and Temperature graphs follows an opposite trend of changing, when temperature rises, energy falls, and vice-versa. Usually we think that, we can get greater output from solar panel in hot weather, but our calculation shows that, solar panel parameters changes with temperature, which in turn gives lower output in very high temperature. The energy falls during the hot summer season, and again start rising at the end of the year, when temperature decreases. The reason can be stated that the decrease in voltage per degree centigrade is more than the increase in current per degree centigrade, so ultimately the power decreases with increasing temperature.

The power curve usually resembles the illumination curve, so the maximum power is obtained when the intensity in maximum; but that is visible when calculating only for a single day, and here the graph shows the energy for a whole year, we cannot show a direct connection of illumination with energy.

5.4.2 Comparison of Energy obtained from both the panels:

In the energy curve, the top curve shows the energy obtained from the mono-crystalline solar module, and the lower one shows the energy obtained from the poly-crystalline solar module. Our calculation resembles with all the existing theory that mono-crystalline solar module is more efficient than poly-crystalline module, and the energy varies in similar manner for throughout the year.

5.4.3 Effect of panel parameters on the Energy calculation:

We obtained higher energy values, when we considered that R_s changes with temperature, as R_s decreases with increasing temperature, so the current flowing in the panel increases, so the power increases, resulting a higher energy than energy calculated by keeping R_s constant. We also considered

5.4.4 Theoretical energy extracted over the year 2013:

20W panels do calculations, and we obtained 41.1kWhr from the mono-crystalline module, and 28.1kWhr from the poly-crystalline module keeping the series resistance constant. When we varied the resistance, we obtained 47.7kWhr and 34.4kWhr for mono and poly modules respectively.

5.5 Outdoors experiment:

The outdoor experiment has been carried out over a week on the rooftop of our university building, but due to many limitations, we could not take data for longer time.

5.5.1 Circuit diagram of the outdoors experiment:

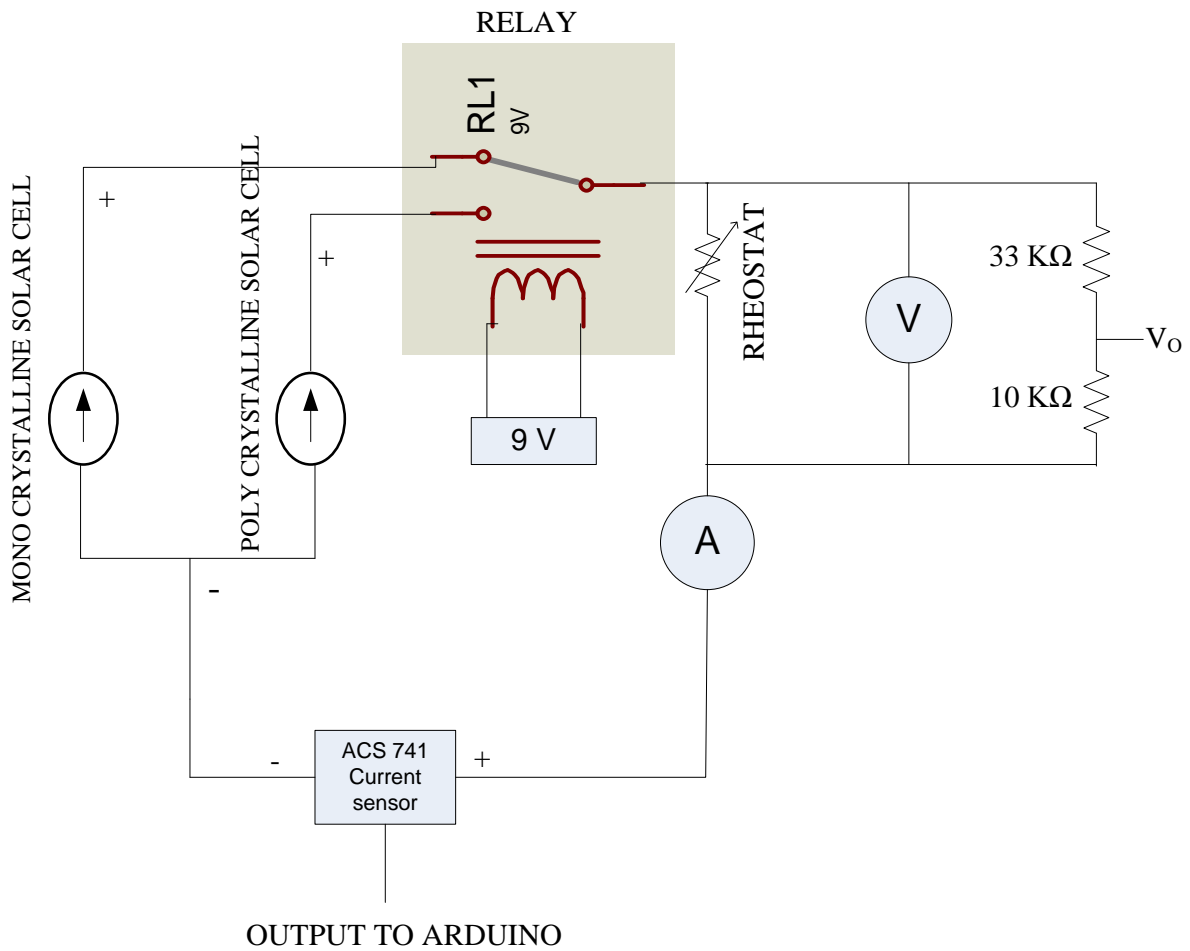

Figure- 5.5: Circuit diagram of the outdoor setup

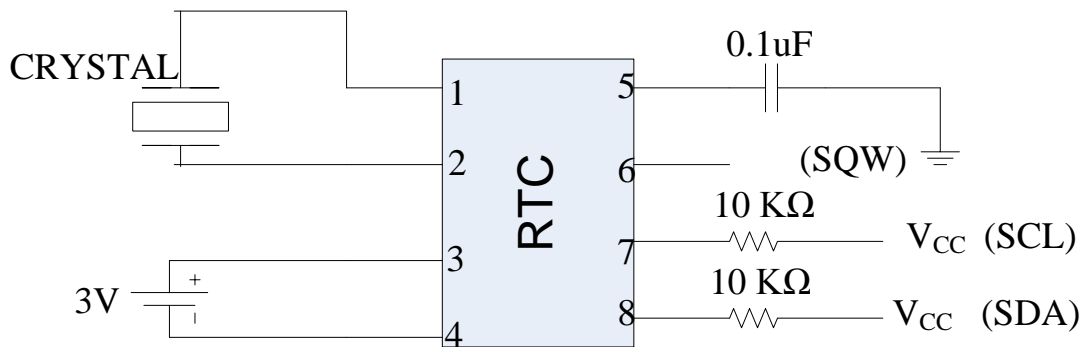

Figure-5.5: Circuit diagram of the real time clock.

5.5.2 Data collection method:

The solar panel is positioned just like in the figure given below, for Bangladesh, for maximum output the panel must have been south facing inclined with 23-degree angle to the horizontal. All the data are recorded just like the indoors-monitoring system; LM35 is used for recording panel surface temperature, voltage divider circuit is used for recording voltage, and ACS714 (current sensor), operated using relay is used for measuring the currents, and all these data are recorded with the help of Arduino Mega 2560. The illumination data has been taken from a reference paper.



5.5.3 Result of outdoor experiment and comparison with the theoretical analysis:

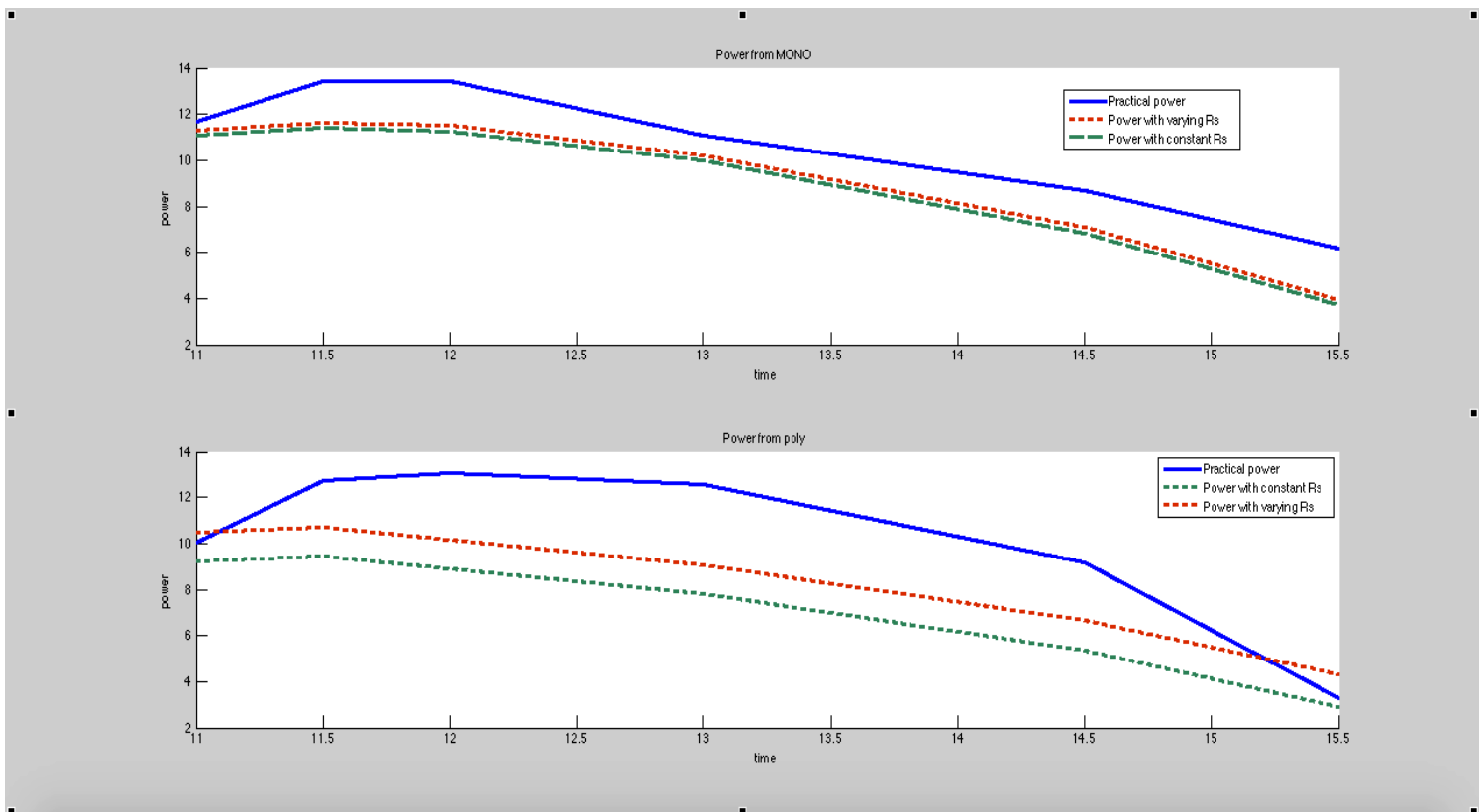

Figure-5.6: Comparing the practical data with the analytical calculation.

The lower most curve shows the power curve without including R_s and the middle curve shows the changing R_s with temperature which is justified by our experiment.

This curve can extract more power than the lower one which shows that the R_s has influence over the power extraction from the solar cell. The top most curve shows the experimental power obtained from the roof top and this shows much more power than the other curve, as it can be a reason of the influence of the other parameter which we have not included in our experiment.

CHAPTER 6

ECONOMIC ANALYSIS

6.1 Introduction

The economic analysis takes into account the opportunity cost of resources in establishing a solar household system and calculating the pros and cons according to our needs. We tried to analyze the social cost and the benefits of the solar PV system. The difference between the two types of solar panels and the cost in establishing three systems (solar with grid, solar with dc, solar with inverter) is described in extended manner for the benefits of the community.

6.2 Solar with grid tied system:

A grid connected photovoltaic power system is a electricity generating system connected with grid. A grid-connected PV system consists of solar panels, inverters, power connecting unit and grid connecting equipment. A simple figure of the solar grid system is given below

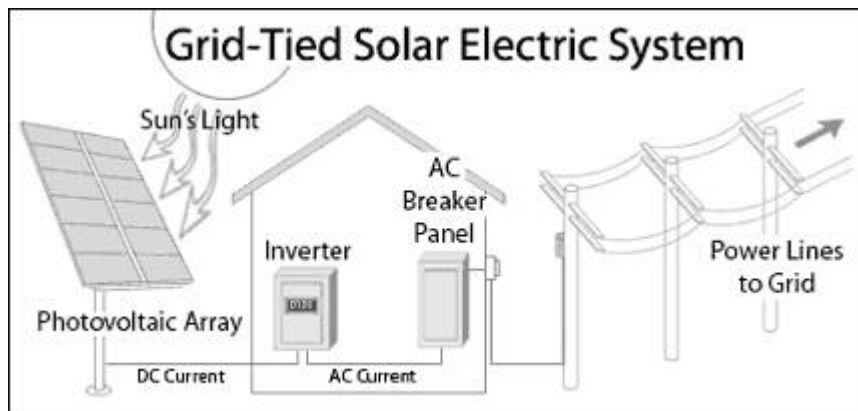

Figure-6.1: Grid-Tied Solar Electric System

6.3 Stand alone solar power system (solar with DC source):

The stand-alone system is completely independent from any electric grid system. During the day, electricity generated is used to power the homes and charge the batteries. A night the

electricity is provided by the batteries. A stand alone system consists of solar panels, batteries, inverters, controllers and metering devices.

The operating voltage of the solar panel in the system must be enough to charge the batteries. For example, a 12V battery needs 14.4V to charge it. The solar panels must be able to give this amount of energy after the power losses, voltage drop in wires and charge controllers.

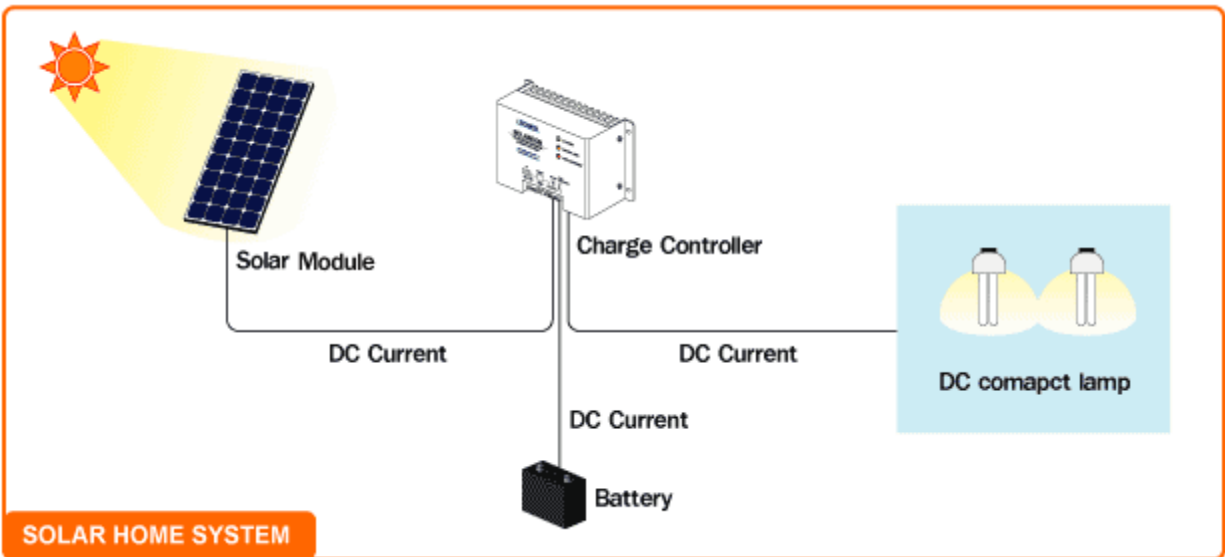

Figure-6.2: Stand alone Solar Power System

6.4 Solar energy system with inverter and charge controller (AC):

Solar power inverters are electrical device which converts the direct current (DC) from the photovoltaic cells to alternating current (AC). This current is then fed into the charge controller to get the required voltage and frequency.

The job of the charge controller is to prolong the lifespan of the battery bank. This is accomplished by stopping the battery from over charging. The controller monitors the battery voltage and reduces the current when the voltage rises. When the voltage drops it again increases the current to charge the battery again. Controllers are selected depending on how much current is required.

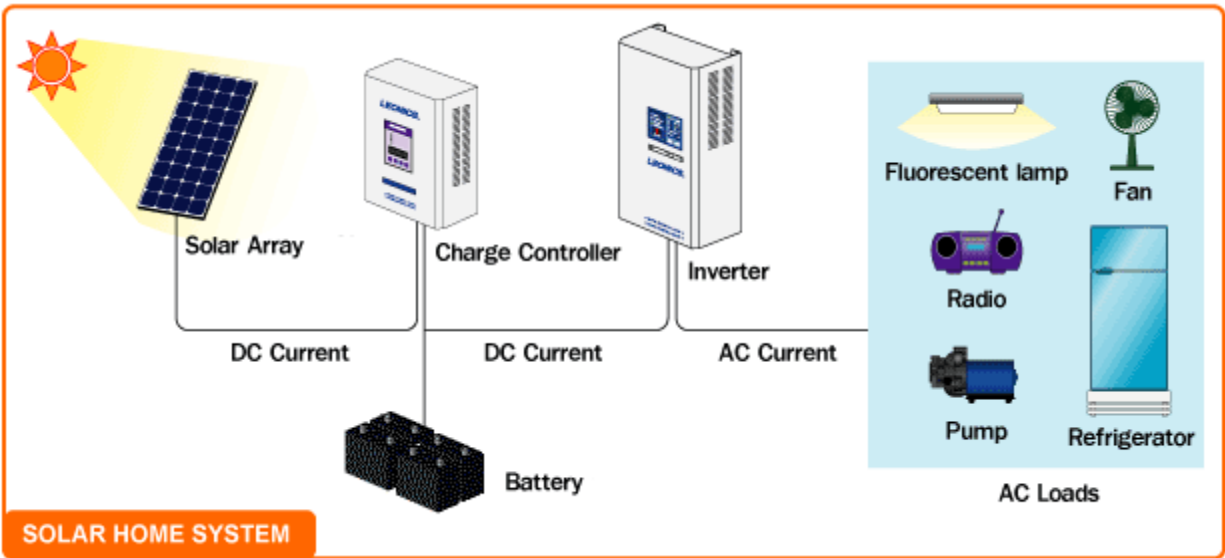

Figure-6.3: solar energy system with AC inverter and charge controller

After describing the three types of systems that can set up in a normal home system, the part which comes into consideration is that the total cost that will be required for setting the systems in a particular household.

We have taken into consideration the conditions of Dhaka city and taking reference from a solar company we were successful in coming to a conclusion of the average cost required.

6.5 Energy extracted:

We have carried out the experiment with two types of solar panels, mono-crystalline and polycrystalline silicon solar panels. When we executed the experiment theoretically as well as practically, we saw that there is a difference in the energy extraction calculated. We carried out those experiments varying and also not varying the series resistance. We finally took the total energy extraction that we got varying the series resistance. The resulting energy for the mono-crystalline was 47.659 kWhr and for polycrystalline panel was 34.386 kWhr from 20W panels. Therefore, for 600W panel energy extracted in 1 yr for mono will be 1429.77kWhr and 1031.58kWhr from poly.

6.6 Equations used for estimating the set up cost:

$$\text{Panel size} = \frac{\text{load} * \text{back up power} * 1.5}{4.5} \quad (6.1)$$

Here in the equation it is multiplied by 1.5 considering the safety factor, and also in the equation it is divided by 4.5 considering the Bangladesh hours and also depending on the sun location.

$$\text{Battery size} = \frac{\text{load} \times \text{back up power}}{0.6 \times \text{voltage}} \quad (6.2)$$

In this equation 0.6 is the depth of discharge (dod)

$$\text{Inverter size} = \text{load} \times 1.25 \quad (6.3)$$

Here also 1.25 is the safety factor.

$$\text{Charge controller size} = \frac{\text{panel size}}{\text{battery size}} \quad (6.4)$$

6.7 Set up cost:

We are trying to set up the solar energy system for a household consisting of three fans and lights. Using the above equations we calculated the amount of cost that will be spent in order to establish the system. We organized and calculated for three types of system.

Load = 380 W (3 lights, 3 fans)

$$\text{Panel size} = \frac{380 \text{ W} \times 4 \text{ hr} \times 1.5}{4.5 \text{ hr}} = 506 \text{ W}$$

$$\text{Battery size} = \frac{380 \text{ W} \times 4 \text{ hr}}{0.6 \times 24 \text{ V} \times 0.85 \times 0.85 \times 0.85} = 171.88 \text{ Ahr at 24V}$$

$$\text{Inverter size} = \frac{380 \text{ W} \times 1.25}{0.8} = 593.75 \text{ VA}$$

As we needed 506W we used the panel size 600W, hence

$$\text{Charge controller} = \frac{600 \text{ W}}{24 \text{ V}} = 25 \text{ A}$$

As there is no charge controller for 25A so we had to take 30A charge controller.

6.7.1 Solar with inverter and charge controller cost calculation (estimation for 20 years)

Item name	Lifespan	Quantity	Unit price	Amount in Tk(for 20 yrs)
Mono panel(300W)	20 yrs	2	70 tk/W	42,000
Poly panel(300W)	20 yrs	2	68 tk/W	40,800
Battery (90 Ahr @12V)	3 to 3.5 yrs	4	9100 per battery	2,18,400
Inverter	3 yrs	1	10,000tk	70,000
Charge controller	2 yr	1	2500tk	25,000
Angle	..			6000
Wire	..			2000
Total amount				3,63,400(mono) 3,62,200(poly)

Table-6.1 Cost calculation for Solar with inverter and charge controller.

6.6.2 Solar with DC cost calculation (estimation for 20 years):

Item name	Lifespan	Quantity	Unit price	Amount in Tk(for 20 yrs)
Mono panel(300W)	20 yrs	2	70 tk/W	42,000
Poly panel(300W)	20 yrs	2	68 tk/W	40,800
Battery (90 Ahr @12V)	6 to 7 yrs	4	9100 per battery	1,09,200
Angle	..			6000
Wire	..			2000
Total amount				1,59,200(mono) 1,58,000(poly)

Table-6.2: Cost calculation for Solar with DC

6.6.3 Solar with Grid system cost calculation (estimated for 20years):

Item name	Lifespan	Quantity	Unit price	Amount in Tk(for 20 yrs)
Mono panel(300W)	20 yrs	2	70 tk/W	42,000
Poly panel(300W)	20 yrs	2	68 tk/W	40,800
Inverter	5 yrs	1	10000	40,000
Angle	..			6000
Wire	..			2000
Total amount				90,000(mono) 88,800(poly)

Table-6.3: Cost calculation for Solar with Grid.

6.6.4 Cost of per kallowatt hour energy:

Total energy over 1 yr		
Mono-crystalline	1429.77 kWhr	
Polycrystalline	1031.588 kWhr	
Solar with inverter and charge controller(AC system)	18,170 Tk (mono) 18,110Tk(poly per yr)	12.71Tk/kWhr 17.56Tk/kWhr
Solar with DC system	7,960 Tk(mono per yr) 7,900 Tk(poly per yr)	5.56Tk/kWhr 7.66Tk/kWhr
Solar with Grid system	4,500 Tk(mono per yr) 4,440 Tk(poly per yr)	3.14Tk/kWhr 4.30Tk/kWhr

Table-6.4: Cost comparison between all systems and types of panel.

6.7 Conclusion:

In Bangladesh polycrystalline panel is widely used as its manufacturing cost is lower than mono-crystalline panel and also initial costing is less. Thinking in a short term basis people prefers polycrystalline panel but according to our calculation thinking in long term basis we get that mono-crystalline panel is more efficient than polycrystalline panel. After doing the above calculation we can estimate that the solar with grid system is more efficient with mono-crystalline panel than other systems. Without considering any system, costing for mono-crystalline panel is 1.4688Tk/kWhr for 600W panel and for polycrystalline panel its 1.97755 Tk/kWhr. So we can conclude that mono-crystalline panel is much more cost efficient than polycrystalline panel.

CHAPTER 7

CONCLUSION

We carried out the indoors-monitoring system experiment to calculate the parameters affecting the solar cells, after finding the parameters theoretically we see that there are other factors affecting as well.

After conducting the whole experiment and analysis to generate a comparative study between the two solar panels, we found that there is a difference in energy calculation in theoretical and experimental result. After conducting the experiment in outdoor monitoring system we got more energy than the theoretical result. Thus we can conclude that there may be some error in our calculation and also there must be some other factors affecting the behavior of solar cells not only temperature and illumination.

According to our calculation we see that there is temperature rise in summer so the energy we achieve falls, we can then deduce that the peak time of the year when we get maximum energy is in the month of March and April, that is, the solar panel acts more efficiently.

Our calculations suggest that mono-crystalline panel would be better for household purpose rather than polycrystalline. It is more cost efficient and energy extraction is more thinking in long term conditions.

Reference :

1. <http://aboutdigitalbangladesh.blogspot.com/2010/04/load-shedding-problem-in-bangladesh.html>
2. http://www.theindependentbd.com/index.php?option=com_content&view=article&id=212828:load-shedding-make-lives-miserable&catid=187:online-edition&Itemid=223
3. www.google.com.bd/url?sa=t&rct=j&q=&esrc=s&source=web&cd=3&cad=rja&uact=8&ved=0CCsQFjAC&url=http%3A%2F%2Fwww.dhakatribune.com%2Fbangladesh%2F2013%2Fjun%2F18%2Fload-shedding-doubles-five-years&ei=lu6TVL31DMiXuATVh4DICw&usg=AFQjCNF6luD7LTffGHU5_e5n-DjgEhyPdg&sig2=C0wQ9dfzGUWG_ZgwWlt7nQ&bvm=bv.82001339,d.c2E
4. <http://www.solarpoweristhefuture.com/why-is-solar-power-important.shtml>
5. http://greenliving.lovetoknow.com/Advantages_and_Disadvantages_of_Solar_Power
6. <http://www.solarpowernotes.com/why-solar-energy.html#.VJOhqV4CA>
7. Roger A. Messenger and Jerry Ventre, “The Sun”, Photovoltaic Systems Engineering, second edition, CRC Press , Boca Raton, Florida, 2003, pp.21-30
8. <http://freemeteo.gr/weather/dhaka/history/daily-history/?gid=1185241&date=2014-01-02&station=9660&language=english&country=bangladesh>
9. <http://www.imagesco.com/articles/photovoltaic/photovoltaic-pg4.html>
10. <http://www.alpstechnologyinc.com/products/5-inches-multicrystalline-silicon-solar-cell>
11. http://en.wikipedia.org/wiki/Solar_cell#mediaviewer/File:Solar_cell.png

APPENDIX

For calculation of illumination:

```
function [x,time] = illumination(n,lat,tr, ts)
trm = tr(1)*60+tr(2)+30;
tsm = ts(1)*60+ts(2)-30;
dif = (tsm - trm) / 19;
time = trm:dif:tsm;
%%latitude for bangladesh in 23.7
td=(ts(1)*60+ts(2)-tr(1)*60+tr(2))/60;
theta= 180/td;

a = length(time);

x = zeros(1,a);
dec= (23.45*pi/180) * sin(((360*(n-80))/365)*pi/180);
lat = (lat*pi)/180;
i = 1;
t = trm/60;
while (i<21);
w = 15* (12-t)*pi/180;
altitude =
asin((sin(dec)*sin(lat))+(cos(dec)*cos(lat)*cos(w)));
AM = 1/(sin(altitude));
p=((AM)^(0.678));
t1=(time(i)-tr(1)*60+tr(2))/60;
theta1=90-(t1*theta);
theta2=(theta1*pi)/180;
y= cos(theta2);
l = 1367*(0.7)^p;
x(1,i) = l*y;
i = i+1;
t = t + dif/60;
end
Lmax= max(x);
Lmin=min(x);
Lavg=sum(x)/20;
%figure();
%plot(time/60,x, 'Linewidth',4), title('Illumination vs
time'),xlabel('time/hr'), ylabel('Illumination W/m^2');
end
```

Reverse saturation current:

```
function [Io, T1]= reversesaturation(n,lat,tr,ts,T2)
q= 1.6e-19;
trm = tr(1)*60+tr(2)+30;
tsm = ts(1)*60+ts(2)-30;
dif = (tsm - trm) / 19;
time = trm:dif:tsm;
To=298;
```

```

n1=1.25;
k=1.38e-23;
Eg=1.12;
Io1= 1.31/(exp((q*.6)/(n1*k*To)));
b=length(T2);
[L]=illumination(n,lat,tr, ts);
for i=1:b;
T1(i)= T2(i) + 32.5*L(i)/1000;
Io(i)= Io1*(T1(i)/To)^3 * exp(-(Eg/(k/q))*(1/T1(i)-1/To));
end
%figure();
%stem(time/60,Io);
end

```

Short circuit current:

```

function [Isc] = shortcircuitcurrent(n,lat,tr, ts)

Isc_ref= 1.31;
trm = tr(1)*60+tr(2)+30;
tsm = ts(1)*60+ts(2)-30;
dif = (tsm - trm) / 19;
time = trm:dif:tsm;
l1= 1000;
[l2] = illumination(n,lat,tr, ts);
for i=1:20
Isc(i) = Isc_ref*(l2(i)/l1);
end

figure()
plot(time, Isc)
end
%mono- Isc=0.66A, Voc=.583, T=27C, Rs= 7.0624mohm.

```

P_{max} codes:

```

function [Pmax,Energy] = powermax(n, lat, tr, ts,T2)
%for mono

Isc = 1.31; %for 25 degree
q = 1.6*10^-19;
n1 = 1.25;
k = 1.38*10^-23;
To = 298;
Rs = 32.844e-3;
Voc = 0.6;
m=1;
max_iter=1000;
tol =1e-3;
p(1)=1.31;
trm = tr(1)*60+tr(2)+30;
tsm = ts(1)*60+ts(2)-30;
dif = (tsm - trm) / 19;

```

```

time = trm:dif:tsm;
a = length(time);

V=0:0.01:0.7;
l=length(V);
[Isc1]=shortcircuitcurrent(n,lat,tr,ts);

[Iol,T1]= reversesaturation(n,lat,tr,ts,T2);

for i=1:a
for m=1:l

    Vt=k*T1(i)/q;

    f=@(x) (Isc1(i)-(Iol(i)*(exp((V(m)+x*Rs)/(nl*Vt)))))-x;
    df=@(x) -(Rs*Iol(i)*exp((V(m) + Rs*x)/(Vt*nl)))/(Vt*nl) -
1;
for c=1:max_iter

    p(c+1)=p(c)-(f(p(c))/df(p(c)));
    err=abs((p(c)-p(c+1))/p(c));

if (err < tol)
break
end
end

I(m)=p(c+1);
p(1)= I(m);
end
figure()
plot(V,I)
%axis([0 1 0 1.5])
%axis([0 1 0 1.5])
for d=1:length(V)
if I(d)>0
    P(d)=V(d)*I(d);
elsebreak
end
end
Pmax(i)= max(P);
Imax(i)=max(I);
t=time/60;
end
figure()
stem(t, Pmax*36),title 'time vs Pmax'
pl=length(Pmax);
f2=2; b=1;
for f1=1:pl-1
    E(b) = 0.5*(Pmax(f1)+Pmax(f2))*(t(f2)-t(f1));
    f2=f2+1;

```

```

        b=b+1;
end

Energy = sum(E)*36;
end
 %[Pmax,Energy] = powermax(141,23.7,[5 14],[18
36],[300.8,300.5,300,301.5,302.5,304,304.5,305,307.8,309.1,310
.1,310.8,311.4,312,312,311.5,310.9,310.4,310,307.9])
%Energy=8.6992

```

Theoretical power mono:

```

function [Pmax,Energy] = theoreticalpowermono(n, lat, tr,
ts,T2)
%for mono

Isc = 1.31; %for 25 degree
q = 1.6*10^-19;
n1 = 1.25;
k = 1.32*10^-23;
To = 298;
Rs = 32.844e-3;
Voc = 0.6;
m=1;
max_iter=1000;
tol =1e-5;
trm = tr(1)*60+tr(2)+30;
tsm = ts(1)*60+ts(2)-30;
dif = (tsm - trm) / 19;
time = trm:dif:tsm;
a = length(time);

V=0:0.01:0.7;
l=length(V);
[Isc1]=shortcircuitcurrentmono(n,lat,tr,ts,T2);

[Io1,T1]= reversesaturationmono(n,lat,tr,ts,T2);
p(1)= 1.31;
for i=1:a
for m=1:l

    Vt=k*T1(i)/q;

    f=@(x) (Isc1(i)-(Io1(i)*(exp(((V(m)+x*Rs)/(n1*Vt))))))-x;
    df=@(x) -(Rs*Io1(i)*exp((V(m) + Rs*x)/(Vt*n1)))/(Vt*n1) -
1;
for c=1:max_iter

    p(c+1)=p(c)-(f(p(c))/df(p(c)));
    err=abs((p(c)-p(c+1))/p(c));

if (err < tol)

```

```

break
end
end

I(m)=p(c+1);
p(1)= I(m);

end
% figure()
% plot(V,I)
% axis([0 1 0 1.5])
for d=1:length(V)
if I(d)>0
    P(d)=V(d)*I(d);
else
break
end
end

Pmax(i)= max(P);
Imax(i)=max(I);
t=time/60;
end
% figure();
% stem(t, Pmax*36),title 'time vs Pmax';
pl=length(Pmax);
f2=2; b=1;
for f1=1:pl-1
    E(b) = 0.5*(Pmax(f1)+Pmax(f2))*(t(f2)-t(f1));
    f2=f2+1;
    b=b+1;
end

Energy = sum(E)*36;
end
%[Pmax,Energy] = powermax(141,23.7,[5 14],[18
36],[300.8,300.5,300,301.5,302.5,304,304.5,305,307.8,309.1,310
.1,310.8,311.4,312,312,311.5,310.9,310.4,310,307.9])
%Energy=8.6992

```

Theoretical power poly:

```

function[Pmax,Energy] = theoreticalpowerpoly(n, lat, tr,
ts,T2)
%for poly

Isc = 1.22; %for 25 degree
q = 1.6*10^-19;
n1 = 1.71;
k = 1.32*10^-23;
To = 298;
Rs = 11.3e-3;

```



```

Voc = 0.567;
m=1;
max_iter=1000;
tol =1e-5;
trm = tr(1)*60+tr(2)+30;
tsm = ts(1)*60+ts(2)-30;
dif = (tsm - trm) / 19;
time = trm:dif:tsm;
a = length(time);

V=0:0.01:0.7;
l=length(V);
[Isc]=shortcircuitcurrentpoly(n,lat,tr,ts,T2);

[Io,T1]= reversesaturationpoly(n,lat,tr,ts,T2);

for i=1:a
    p(1)=1.22;
    for m=1:l

        Vt=k*T1(i)/q;

        f=@(x) Isc(i) - (Io(i) * (exp(((V(m)+x*Rs) / (n1*Vt)))) - x;
        df=@(x) - (Io(i)*Rs*q*exp(((V(m) +
Rs*x)/(Vt*n1)))/(Vt*n1)) - 1;

        for c=1:max_iter

            p(c+1)= p(c) - (f(p(c))/df(p(c)));
            err=abs((p(c+1)-p(c))/p(c));

            if (err < tol)
                break
            end
        end

        I(m)=p(c+1);
        p(c)= I(m);
        end
        %figure()
        %plot(V,I)
        %axis([0 1 0 1.5])
        for d=1:length(V)
            if I(d)>0
                P(d)=V(d)*I(d);
            else
                break
            end
        end

        Pmax(i)= max(P);

```

```

Imax(i)=max(I);
t=time/60;
end
%figure();
%stem(t, Pmax*36),title 'time vs Pmax';
pl=length(Pmax);
f2=2; b=1;
for f1=1:pl-1
    E(b) = 0.5*(Pmax(f1)+Pmax(f2))*(t(f2)-t(f1));
    f2=f2+1;
    b=b+1;
end

Energy = sum(E)*36;
end
%[Pmax,Energy] = powermax(141,23.7,[5 14],[18
36],[300.8,300.5,300,301.5,302.5,304,304.5,305,307.8,309.1,310
.1,310.8,311.4,312,312,311.5,310.9,310.4,310,307.9])
%Energy=8.6992

```

I₀ of mono with experimental values:

```

function [Io, T1]= expreversemono(n,lat,tr,ts,T2)
q= 1.6e-19;
trm = tr(1)*60+tr(2)+30;
tsm = ts(1)*60+ts(2)-30;
dif = (tsm - trm) / 19;
time = trm:dif:tsm;
To=298;
n1=1.25;
k=1.38e-23;
Eg=1.12;
Io1= 0.41/(exp((q*.572)/(n1*k*To)));
b=length(T2);
[L]=illumination(n,lat,tr, ts);
for i=1:b;
T1(i)= T2(i) + 32.5*L(i)/1000;
Io(i)= Io1*(T1(i)/To)^3 * exp(-(Eg/(k/q))*(1/T1(i)-1/To));
end
%figure();
%stem(time/60,Io);
end

```

I₀ of ploy with experimental value:

```

function [Io, T1]= expreversepoly(n,lat,tr,ts,T2)
q= 1.6e-19;
trm = tr(1)*60+tr(2)+30;
tsm = ts(1)*60+ts(2)-30;
dif = (tsm - trm) / 19;
time = trm:dif:tsm;
To=298;
n1=1.71;

```

```

k=1.38e-23;
Eg=1.12;
Io1= 0.40/(exp((q*.567)/(n1*k*To)));
b=length(T2);
[L]=illumination(n,lat,tr, ts);
for i=1:b;
T1(i)= T2(i) + 32.5*L(i)/1000;
Io(i)= Io1*(T1(i)/To)^3 * exp(-(Eg/(k/q))*(1/T1(i)-1/To));
end
%figure();
%stem(time/60,Io);
End

```

I_{sc} experimental for mono:

```

function [Isc] = shortcircuitcurrentmono(n,lat,tr, ts,T2)
Isc_ref= 1.31;
l1= 1000;
[l2] = illumination(n,lat,tr, ts);
[Io, T1]= reversesaturationmono(n,lat,tr,ts,T2);
for i=1:20
Isc(i) = Isc_ref*(l2(i)/l1)*(1+0.0011*(T1(i)-298));
end
end
%mono- Isc=0.66A, Voc=.583, T=27C, Rs= 7.0624mohm.

```

I_{sc} experimental poly:

```

function [Isc] = shortcircuitcurrentpoly(n,lat,tr, ts)
Isc_ref= 1.22;
l1= 1000;
[l2] = illumination(n,lat,tr, ts);
for i=1:20
Isc(i) = Isc_ref*(l2(i)/l1);
end
end
%mono- Isc=0.66A, Voc=.583, T=27C, Rs= 7.0624mohm.

```

Iteration for analytical for varying R_s for mono:

```

function [Pmax,Energy] = expmono(n, lat, tr, ts,T2)
q = 1.6*10^-19;
n1 = 1.25;
k = 1.38*10^-23;
max_iter=1000;
tol =1e-3;
trm = tr(1)*60+tr(2)+30;
tsm = ts(1)*60+ts(2)-30;
dif = (tsm - trm) / 19;
time = trm:dif:tsm;
a = length(time);

[Io,T1] = expreversemono(n,lat,tr,ts,T2);
[Isc] = shortcircuitcurrentmono(n,lat,tr, ts,T2);
[L,time] = illumination(n,lat,tr, ts);

```

```

for b=1:length(T1)
%     Isc(b)= 0.0011*T1(b) +0.084;
%     Voc(b)= -0.0018*T1(b) + 1.1;
    Vt(b)=k*T1(b)/q;
end

%Rs=[1.768,1.3726,1.109,.7795,.77146,.76543,.7594,.67598,.5508
5,.50914,.46743,.55085,.50914,.59256,.67598,.76141,.76945,.777
49,1.0431,1.2408];
for i = 1:length(T1)
    t = T1(i);
    R(i)= (-3.4e-9 *t^4 + 2e-6 * t^3 + 0.00052* t^2 - 0.52 *t
+ 84)/84;
    Rs(i)=32.844e-3*(1000/L(i))*R(i);

%     if t<=298
%         Rs(i) = 1.109 + 65.9e-3*(298-t);
%     elseif t<=303
%         Rs(i) = 1.109 - 65.9e-3*(t-298);
%     elseif t<=313
%         Rs(i) = 0.7795 - 2.01e-3*(t-303);
%     elseif t<=323
%         Rs(i) = 0.7594 - 41.71e-3*(t-313);
%     else
%         Rs(i) = 0.3423 - 5.084e-3*(t-323);
%     end
end

p(1)=1.31;
for i=1:a
    I=0;
    V=0:0.001:0.7;
    l= length(V);

for m=1:l

    f=@(x) (Isc(i)-
(Io(i)*(exp(((V(m)+x*Rs(i))/(n1*Vt(i))))))-x;
    df=@(x) -(Rs(i)*Io(i)*exp((V(m) +
Rs(i)*x)/(Vt(i)*n1)))/(Vt(i)*n1) - 1;
for c=1:max_iter

    p(c+1)=p(c)-(f(p(c))/df(p(c)));
    err=abs((p(c)-p(c+1))/p(c));

if (err < tol)
break
end

```

```

end

I(m)=p(c+1);
p(1)= I(m);
end
% figure()
% plot(V,I)
% axis([0 0.7 0 1.5])

for d=1:length(V)
if I(d)>0
    P(d)=V(d)*I(d);
elsebreak
end
end

Pmax(i)= max(P);
Imax(i)=max(I);
end
t=time/60;
% figure()
% subplot(211)
% stem(t, Pmax*36),title 'time vs Pmax'
% subplot(212)
% stem(t, T1-273), title 'time vs Temperature in C'
pl=length(Pmax);
f2=2; b=1;
for f1=1:pl-1
    E(b) = 0.5*(Pmax(f1)+Pmax(f2))*(t(f2)-t(f1));
    f2=f2+1;
    b=b+1;
end

Energy = sum(E)*36;
end

```

Iteration for analytical for varying R_s for poly:

```

function[Pmax,Energy] = exppoly(n, lat, tr, ts,T2)
q = 1.6*10^-19;
n1 = 1.71;
k = 1.38*10^-23;
max_iter=1000;
tol =1e-3;
trm = tr(1)*60+tr(2)+30;
tsm = ts(1)*60+ts(2)-30;
dif = (tsm - trm) / 19;
time = trm:dif:tsm;
a = length(time);

[Io,T1] = expreversepoly(n,lat,tr,ts,T2);
[Isc] = shortcircuitcurrentpoly(n,lat,tr, ts,T2);

```

```

[L,time] = illumination(n,lat,tr, ts);

for b=1:length(T1)
%     Isc(b)= 0.00096*T1(b) +0.12;
%     Voc(b)= -0.0017*T1(b) + 1.1;
    Vt(b)=k*T1(b)/q;
end

%Rs=[1.768,1.3726,1.109,.7795,.77146,.76543,.7594,.67598,.5508
5,.50914,.46743,.55085,.50914,.59256,.67598,.76141,.76945,.777
49,1.0431,1.2408];
for i = 1:length(T1)
    t = T1(i);
%     if t<=298
%         Rs(i) = .8706 + 45.45e-3*(298-t);
%     elseif t<=308
%         Rs(i) = .8706 - 45.45e-3*(t-298);
%     elseif t<=348
%         Rs(i) = 0.4161 - 4.005e-3*(t-308);
%     elseif t<=358
%         Rs(i) = 0.2559 - 3e-3*(t-348);
%     elseif t<=363
%         Rs(i) = 0.2259 - 22.92e-3*(t-358);
%     else
%         Rs(i)=0.1113- 3.55e-3*(t-363);
%     end
R(i)= (-3.9e-9*t^5 - 6.8e-6*t^4 + 0.0047*t^3- 1.6*t^2 +
2.8e+2*t + 2e+4)/(2e+4);
Rs(i)=11.3e-3*(1000/L(i))*R(i);
end

p(1)=Isc(1);
for i=1:a
    I=0;
    V=0:0.001:0.7;
    l= length(V);

for m=1:l

    f=@(x) (Isc(i)-
(Io(i)*(exp(((V(m)+x*Rs(i))/(n1*Vt(i))))))-x;
    df=@(x) -(Rs(i)*Io(i)*exp((V(m) +
Rs(i)*x)/(Vt(i)*n1)))/(Vt(i)*n1) - 1;
for c=1:max_iter

    p(c+1)=p(c)-(f(p(c))/df(p(c)));
    err=abs((p(c)-p(c+1))/p(c));

```

```

if (err < tol)
break
end
end

I(m)=p(c+1);
p(1)= I(m);
end
% figure()
% plot(V,I)
% axis([0 0.7 0 1.2])
P = V.*I;

for d=1:length(V)
if I(d)>0
P(d)=V(d)*I(d);
elsebreak
end
end

Pmax(i)= max(P);
Imax(i)=max(I);
end
t=time/60;
% figure()
% subplot(211)
% stem(t, Pmax*36),title 'time vs Pmax'
% subplot(212)
% stem(t, T1-273), title 'time vs Temperature in C'
pl=length(Pmax);
f2=2; b=1;
for f1=1:pl-1
E(b) = 0.5*(Pmax(f1)+Pmax(f2))*(t(f2)-t(f1));
f2=f2+1;
b=b+1;
end

Energy = sum(E)*36;
end

```

Comparison of analytical energy with constant R_s :

```

clc;
close all;
clear all;

[jan1,ene1] = theoreticalpowermono(1,23.7,[6 41],[17
23],[12,12.03,12.35,12.68,13.35,13.68,14.875,15.708,17.375,18.
208,19.875,20.083,22.375,23.208,24.35,24.68,24.65,24.32,22.65,
22.32]+273);

```

```

[jan3,ene3] = theoreticalpowermono(3,23.7,[6 41],[17
24],[16,16.03,16.7,17.37,18.525,19.025,20.025,20.525,21.7,22.3
7,23.35,23.68,24.35,24.68,24.825,24.658,24.325,24.158,23.3,22.
63]+273);
[jan4,ene4] = theoreticalpowermono(4,23.7,[6 42],[17
25],[16.35,16.68,17.7,18.37,19.35,19.68,20.7,21.37,22.7,23.37,
24.35,24.68,25,25,25,25,24.65,24.32,23.97,23.65]+273);
[jan5,ene5] = theoreticalpowermono(5,23.7,[6 42],[17
26],[15.37,15.7,16,16,16.73,17.4,18.73,19.4,20.73,21.4,22.37,2
2.7,23.37,23.7,24.37,24.7,25,25,24.63,24.3]+273);
[jan6,ene6] = theoreticalpowermono(6,23.7,[6 42],[17
26],[15.37,15.7,16,16,16.73,17.4,18.73,19.4,20.37,20.7,21.73,2
2.4,23,23,23,23,22.27,21.6,21,21]+273);
[jan7,ene7] = theoreticalpowermono(7,23.7,[6 42],[17
27],[14.37,14.7,15.37,15.7,16,16,16.73,17.4,18.73,19.4,20,20,2
0,20,20,20,20,19.63,19.3]+273);
[jan8,ene8] = theoreticalpowermono(8,23.7,[6 42],[17
28],[10,10.03,10.37,10.7,11.37,11.7,13.1,14.1,15.37,15.7,16.37
,16.7,17,17,17,17,17,17,16.97,15.97]+273);
[jan9,ene9] = theoreticalpowermono(9,23.7,[6 42],[17
29],[8.27,7.93,8.1,9.1,10.73,11.4,12.37,12.7,13,13,13.37,13.7,
14.37,14.7,15.37,15.7,16,16,14.63,14.3]+273);
[jan10,ene10] = theoreticalpowermono(10,23.7,[6 43],[17
29],[7.38,7.72,8.38,8.72,9.38,9.72,10.77,11.43,12.77,13.43,14.
77,15.43,16.38,16.72,17.38,17.72,17.63,17.28,16.62,16.28]+273)
;
[jan15,ene15] = theoreticalpowermono(15,23.7,[6 43],[17
33],[13.38,13.72,14.77,15.43,17.15,18.15,19.7,20.43,21.77,22.4
3,25,25,25,25,25.38,25.72,25.62,25.28,24.62,24.28]+273);
[jan18,ene18] = theoreticalpowermono(18,23.7,[6 43],[17
35],[14.38,14.72,15.92,18.58,20.77,21.43,22.38,22.72,23.77,24.
43,25.77,26.43,27.38,27.72,28.38,28.72,28.23,27.57,26.23,25.57
]+273);
[jan20,ene20] = theoreticalpowermono(20,23.7,[6 42],[17
36],[17,17,17.38,17.72,18.77,19.43,20.38,20.72,21.38,21.72,22.
38,22.72,23.77,24.43,25.38,25.72,26,26,25.23,24.57]+273);
[jan23,ene23] = theoreticalpowermono(23,23.7,[6 42],[17
39],[15.63,15.3,15.73,16.4,17.73,18.4,19.73,20.4,21.73,22.4,23
.73,24.4,26.1,27.1,28,28,27.27,26.6,25.63,25.3]+273);
[jan25,ene25] = theoreticalpowermono(25,23.7,[6 41],[17
40],[12,12,12.4,12.74,14.2,15.2,16.4,16.73,17.4,17.73,19.2,20.
2,21.8,22.47,23,23,23,22.93,22.27,21.93]+273);
[jan27,ene27] = theoreticalpowermono(27,23.7,[6 41],[17
41],[12,12,12.4,12.75,14.35,15.4,16.5,16.85,17.55,17.9,19.8,20
.85,22.3,23,23,23,23,22.9,22.2,21.85]+273);
[jan29,ene29] = theoreticalpowermono(29,23.7,[6 40],[17
43],[12.65,12.3,12.4,12.75,14.8,16.2,18.5,19.55,21.1,21.8,23.2
,23.9,24.65,25,25,25,25,24.9,24.2,23.85]+273);
[jan31,ene31] = theoreticalpowermono(31,23.7,[6 40],[17
44],[15.35,15.7,16.4,16.75,17.45,17.8,19,19.7,21.65,22.7,24.8,
25.85,26.65,27,27.7,27.95,27.35,26.8,25.4,23.85]+273);

```



```

energy1=
(ene1+ene3+ene4+ene5+ene6+ene7+ene8+ene9+ene10+ene15+ene18+ene
20+ene23+ene25+ene27+ene29+ene31)/17;
total1=energy1*31;
Energy1=[ene1,ene3,ene4,ene5,ene6,ene7,ene8,ene9,ene10,ene15,e
ne18,ene20,ene23,ene25,ene27,ene29,ene31];
Jan=[1,3,4,5,6,7,8,9,10,15,18,20,23,25,27,29,31];
%figure()
%plot(Jan,Energy1,'Linewidth',3),title('Energy in
January'),xlabel('January'), ylabel('Energy /Whr')

%

[feb1,ene32] = theoreticalpowermono(32,23.7,[6 39],[17
45],[15.32,15.67,16.73,17.43,18.83,19.53,20.93,21.63,22,22,23.
13,23.83,23.38,23.03,23,22.98,22.28,22,22,22]+273);
[feb2,ene33] = theoreticalpowermono(33,23.7,[6 39],[17
46],[15.32,15.67,16.73,17.43,18.83,19.53,20.93,21.63,23.03,23.
73,25.13,26.08,26.62,26.97,27,26.98,26.28,25.93,25.23,24.88]+2
73);
[feb4,ene35] = theoreticalpowermono(35,23.7,[6 38],[17
47],[17.3,17.65,18.7,19.4,20.8,21.5,22.9,23.6,25.5,26.55,27.55
,27.9,28,28,28,28,27.3,26.95,26.25,25.9,]+273);
[feb9,ene40] = theoreticalpowermono(40,23.7,[6 35],[17
50],[18.25,18.6,19.3,19.65,21.05,22.1,23.4,23.75,24.45,24.8,26
.1,26.7,27,27,27.6,27.95,27.45,27,26.3,25.95]+273);
[feb13,ene44] = theoreticalpowermono(44,23.7,[6 33],[17
53],[19,19,19.53,20.23,21.63,22.33,23.73,24.43,25.83,26.53,28.
03,28.63,29.52,29.87,30,30,30,30,29.33,28.98]+273);
[feb21,ene52] = theoreticalpowermono(52,23.7,[6 27],[17
57],[19,19,19.43,20.17,21.63,22.37,23.83,24.57,26.03,26.77,28.
23,28.97,29.72,30,30,30,30,29.72,28.97,28.23]+273);
[feb22,ene53] = theoreticalpowermono(53,23.7,[6 26],[17
58],[21.2,21.6,22.1,22.6,23.5,24.6,25.4,25.8,26.5,26.8,27.4,27
.9,28.7,29.5,31.8,31.6,31.2,30.8,30,29.6]+273);
[feb23,ene54] = theoreticalpowermono(54,23.7,[6 26],[17
58],[19,19,19.4,20.5,21.5,22.3,24.2,25.3,27,27.73,29.2,29.93,3
1.4,32.13,32,32,32,31.8,31,29.9]+273);
[feb25,ene56] = theoreticalpowermono(56,23.7,[6 24],[17
59],[21.1,21.4,22.54,23.8,25.45,26.69,27.2,27.84,28.64,28.89,2
9,29,29.64,30.1,30.79,31.4,31.93,31.5,30.07,29.33]+273);
[feb27,ene58] = theoreticalpowermono(58,23.7,[6 22],[18
00],[20,20,20.8,23,26.23,26.6,27.33,28.4,29.43,29.8,30.53,30.9
,31.63,32,32.73,32.53,31.6,30.87,29.7,29.33]+273);
[feb28,ene59] = theoreticalpowermono(59,23.7,[6 21],[18
01],[20,20,20.35,21.45,23.65,24.35,25.3,25.79,26.35,27.65,29.0
3,29.77,31.23,31.97,32.72,32.92,32.18,31.82,31.08,30.72]+273);

energy2=(ene32+ene33+ene35+ene40+ene44+ene52+ene53+ene54+ene56
+ene58+ene59)/11;

```

```

total2= energy2*28;
Energy2=[ene32,ene33,ene35,ene40,ene44,ene52,ene53,ene54,ene56
,ene58,ene59];
Feb =[1,2,4,9,13,21,22,23,25,27,28];
%figure()
%plot(Feb,Energy2,'Linewidth',3),title('Energy in
February'),xlabel('February'), ylabel('Energy/Whr')

%

[mar1,ene60] = theoreticalpowermono(60,23.7,[6 21],[18
01],[20.03,20.38,21.23,21.97,23.43,24.17,25.63,26.37,25.83,26.
57,27.52,27.88,29.62,29.98,30.72,31,31,30.82,30.02,29.43]+273)
;
[mar3,ene62] = theoreticalpowermono(62,23.7,[6 19],[18
02],[18.99,19.65,21.33,22.73,24.18,24.55,25.65,26.75,27.72,28.
63,29.67,30.78,31.665,31.97,32,31.91,31.13,30.98,30.63,29.5]+2
73);
[mar5,ene64] = theoreticalpowermono(64,23.7,[6 17],[18
03],[21,21.32,22.15,23.25,25.45,26.55,28.5,29.23,30.35,30.72,3
1.45,31.82,32.55,32.92,33,32.98,32.35,32,32,31.57]+273);
[mar7,ene66] = theoreticalpowermono(66,23.7,[6 15],[18
04],[22,22.85,25.05,25.38,26.12,26.48,27.22,27.58,28.32,28.68,
29.83,30.57,32.03,32.77,32.42,32.12,32.28,31.98,31.12,28.63]+2
73);
[mar9,ene68] = theoreticalpowermono(68,23.7,[6 13],[18
05],[20,20,20,22.1,26.5,26.9,28.37,29.1,30.28,30.65,31.38,31.7
5,32.48,32.85,33,33,31.28,32,31.53,30.87]+273);
[mar11,ene70] = theoreticalpowermono(70,23.7,[6 11],[18
06],[24,24,24,24.35,25,25,25,25,25.35,25.88,27.05,28.5,29.33,2
9.69,31.34,32.98,32,32,31.35,31]+273);
[mar12,ene71] = theoreticalpowermono(71,23.7,[6 10],[18
06],[24.8,25.35,25.99,26,26.23,26.57,27.28,27.67,28.43,28.82,2
9.58,29.97,31.47,32.23,30.23,30,29.97,29.58,29,29]+273);
[mar13,ene72] = theoreticalpowermono(72,23.7,[6 09],[18
07],[24.88,25.31,25.98,26.23,27.13,28.35,30,30,31.65,31.88,32,
32,31.65,31,31,30.75,29.97,29.2,27.83,27.45]+273);
[mar15,ene74] = theoreticalpowermono(74,23.7,[6 08],[18
07],[25.2,25.37,26.9,26.67,29.1,29.48,30.25,30.63,31.4,31.78,3
2.55,32.93,33.7,34,34,34,34,34,33.7,32.93]+273);
[mar16,ene75] = theoreticalpowermono(75,23.7,[6 07],[18
08],[25.22,25.17,25.93,26.32,27.08,27.93,29.23,29.62,30.38,30.
77,31.53,31.92,32,32.2,34.5,34.88,34.12,34.27,32,32]+273);
[mar17,ene76] = theoreticalpowermono(76,23.7,[6 06],[18
08],[25,25.15,25.92,26.3,27.07,27.9,29.22,29.6,30.37,30.75,31,
31,32.33,33,33,32.8,32.03,30.95,28.65,27.5]+273);
[mar18,ene77] = theoreticalpowermono(77,23.7,[6 05],[18
09],[21.35,21.27,22.8,23.57,25.1,25.43,26.4,27.17,28.7,29.47,3
1,31.77,32.65,33,33,33,33,32.33,30.9,30.52]+273);

```

```

[mar20,ene79] = theoreticalpowermono(79,23.7,[6 03],[18
09],[24.28,24,24,24.5,26.02,26.4,27.17,27.55,28.95,30.1,31.93,
32.7,34.23,35,35,34.85,34.02,34,33.8,32.65]+273);
[mar22,ene81] = theoreticalpowermono(81,23.7,[6 01],[18
10],[25,25.06,25.83,26.22,26.98,27.37,28.17,29.03,30.57,31.33,
32,32,32.58,32.97,33,33,33,32.2,29.93,29.17]+273);
[mar23,ene82] = theoreticalpowermono(82,23.7,[6 00],[18
11],[24.67,25,25,25.4,26.93,27.9,29,29,27.8,28.95,32,32,32.57,
32.95,32.37,32.9,32.14,31.75,29.99,29.6]+273);
[mar24,ene83] = theoreticalpowermono(83,23.7,[05 59],[18
11],[25,25.02,25.76,26.35,28.3,29.22,29.95,30.32,31.05,31.42,3
2,32,32.5,32.62,33.35,33.72,34,33.98,33.02,32.43]+273);
[mar25,ene84] = theoreticalpowermono(84,23.7,[05 58],[18
11],[25,25.03,26.6,27.8,28.87,29.8,31.08,31.47,32.47,33.23,34.
3,34.77,35.53,35.92,36,35.93,35.17,34.78,34.02,34]+273);
[mar26,ene85] = theoreticalpowermono(85,23.7,[05 57],[18
12],[26.65,27,27.76,28.13,28.95,29.9,32.2,32.45,33.43,34.2,35,
35,35,35.67,36.05,36.82,35.8,34.04,33.3]+273);
[mar27,ene86] = theoreticalpowermono(86,23.7,[05 56],[18
12],[27,27,27.75,28.13,28.9,29.57,31.1,31.887,33.4,33.58,34.35
,34.73,35,34.73,34.27,34,34,33.82,33.04,32]+273);
[mar29,ene88] = theoreticalpowermono(88,23.7,[05 54],[18
13],[25,25,25,25.2,26.73,27.25,28.03,28.8,30,30,30.95,32.1,33.
93,34.7,35.62,36,34.47,34.98,32.17,32]+273);
[mar30,ene89] = theoreticalpowermono(89,23.7,[05 53],[18
13],[26.55,26.93,27.7,28.25,30.55,31.23,32,32,32,32,32,32,32,3
2,33.8,34.95,35,34.87,34.1,33.72]+273);
[mar31,ene90] = theoreticalpowermono(90,23.7,[05 52],[18
14],[26,26,26.68,27,27,27.22,27.98,28.73,30.133,30.52,31.28,31
.67,32,32,33.75,34.9,35,35,33.23,32.57]+273);

energy3=(ene60+ene62+ene64+ene66+ene68+ene70+ene71+ene72+ene74
+ene75+ene76+ene77+ene79+ene81+ene82+ene83+ene84+ene85+ene86+e
ne88+ene89+ene90)/22;
total3=energy3*31;
Energy3=[ene60,ene62,ene64,ene66,ene68,ene70,ene71,ene72,ene74
,ene75,ene76,ene77,ene79,ene81,ene82,ene83,ene84,ene85,ene86,e
ne88,ene89,ene90];
Mar=[1,3,5,7,9,11,12,13,15,16,17,18,20,22,23,24,25,26,27,29,30
,31];
%figure()
%plot(Mar,Energy3,'Linewidth',3),title('Energy in
March'),xlabel('March'),ylabel('Energy/Whr')

%

[apr3,ene93] = theoreticalpowermono(93,23.7,[05 49],[18
15],[25,24.72,24.42,24.25,26.65,27.85,30.25,30.48,31.28,32.37,
33.48,33.88,34.68,35.08,35.88,35.72,34.83,34.03,32.72,32.42]+2
73);

```

```

[apr4,ene94] = theoreticalpowermono(94,23.7,[05 48],[18
15],[26,26,26.65,27.15,28.55,30.5,32.1,32.9,34.25,34.65,35.25,
35.65,36,36.1,37.9,38,37.95,37.65,36.5,35.7]+273);
[apr5,ene95] = theoreticalpowermono(95,23.7,[05 47],[18
16],[26,26,27.9,29,29,29.23,30.07,30.87,32.47,33.67,34.43,34.8
3,35,35,35,34.77,33.97,33.57,32.77,32.37]+273);
[apr6,ene96] = theoreticalpowermono(96,23.7,[05 46],[18
16],[25.23,25.87,27.27,28.07,28.83,29.23,30.03,30.43,31.23,32.
27,33.43,33.83,34.63,35.03,35.83,36.03,34.97,34.47,33.53,32.73
]+273);
[apr7,ene97] = theoreticalpowermono(97,23.7,[05 45],[18
16],[27,27,28.23,28.03,29.63,30.43,32.03,32.42,33.22,33.62,34,
34,34,34.03,35.63,36,35.97,35.27,34.43,33.77]+273);
[apr9,ene99] = theoreticalpowermono(99,23.7,[05 43],[18
17],[27,27,27.58,27.98,29.57,30.37,31.97,32.38,33.37,34.17,35.
38,35.78,36.58,36.98,36.22,36,36,35.62,34.82,34.42]+273);
[apr10,ene100] = theoreticalpowermono(100,23.7,[05 42],[18
18],[27.37,27.77,28.57,28.97,29,29.17,29.97,30.37,31.33,32.13,
33,33,34.13,34.93,36.13,37,37,36.63,35.83,35.43]+273);
[apr11,ene101] = theoreticalpowermono(101,23.7,[05 41],[18
18],[27,27,27.55,27.95,28.75,29.15,29.95,30.35,31.15,31.55,32.
7,33.5,34.15,34.95,35,34.7,33.1,33,32.85,32.45]+273);
[apr12,ene102] = theoreticalpowermono(102,23.7,[05 40],[18
18],[27.33,27.73,29.07,29.87,30.73,31.13,32.87,33.67,35.27,35.
53,36.33,36.73,37,37,37,36.87,36.03,35.77,34.73,33.93]+273);
[apr13,ene103] = theoreticalpowermono(103,23.7,[05 39],[18
19],[26,26,28.07,29.67,30.72,31.12,31.92,32.32,33.12,33.73,35.
63,36.43,37,37,37,37,37,36.68,35.88,35.48]+273);
[apr14,ene104] = theoreticalpowermono(104,23.7,[05 38],[18
19],[27.6,28.4,29.5,29.9,30.7,31.1,32.8,33.6,35.2,35.5,35.7,35
.3,34.5,34.1,31.9,30.7,31.9,32,32,32]+273);
[apr15,ene105] = theoreticalpowermono(105,23.7,[05 37],[18
20],[26.28,26.68,27.48,27.88,29.37,30,30,30.28,31.08,31.28,32.
57,33.37,34.28,34.68,35,34.92,34.22,33.82,32.98,32.52]+273);
[apr16,ene106] = theoreticalpowermono(106,23.7,[05 37],[18
20],[24,24,24.48,24.88,25.68,26.08,27.77,28.28,29.08,29.48,30,
30,30,30,30.68,30.92,30.22,30,29.92,29.62]+273);
[apr17,ene107] = theoreticalpowermono(107,23.7,[05 36],[18
21],[23,23,21.13,19.53,19.67,20.07,21.73,22.5,24.13,25.4,27.8,
29,29.53,29.12,29.67,30,30,29.83,28.93,28.53]+273);
[apr18,ene108] = theoreticalpowermono(108,23.7,[05 35],[18
21],[25.25,25.65,26,26,26.65,27.05,27.85,28.23,29.05,29.45,30.
05,30.65,31.45,31.85,33,32.85,32.15,31.85,29.9,30.1]+273);
[apr19,ene109] = theoreticalpowermono(109,23.7,[05 34],[18
21],[25.23,25.63,26,26,27.27,28.07,28.83,29.43,31.07,31.43,32.
23,32.63,33,33,33.63,34,34,33.87,32.97,32.67]+273);
[apr20,ene110] = theoreticalpowermono(110,23.7,[05 33],[18
22],[22.23,22.62,23.83,24.63,26.85,28,28,28.2,29.02,29.42,30.2
2,30.62,31,31,32.23,33,33,32.88,31.98,31.88]+273);

```

```

[apr21,ene111] = theoreticalpowermono(111,23.7,[05 32],[18
22],[26,26,26.8,27.6,28.62,29,29.8,30,30,30.4,31.03,31.6,32,32
,32,31.97,30.4,30,30,29.6]+273);
[apr22,ene112] = theoreticalpowermono(112,23.7,[05 31],[18
23],[23.18,23.6,24,24,24.6,24.98,24.32,24.17,24.98,25.38,26.18
,26.58,27,27,27.58,28,28,28,28,28]+273);
[apr23,ene113] = theoreticalpowermono(113,23.7,[05 31],[18
23],[23.37,24.17,25.77,26.57,27.6,27.98,28.78,29.17,29.98,30.7
7,32,32,32,32,31.42,31,32.57,32.73,31.03,30.62]+273);
[apr24,ene114] = theoreticalpowermono(114,23.7,[05 30],[18
23],[24,24,24.73,25.53,27.17,27.93,29.53,30.3,31.93,32.73,33.8
3,33.43,33.73,34.53,34.43,34.02,33.34,32.83,32.04,32]+273);
[apr25,ene115] = theoreticalpowermono(115,23.7,[05 29],[18
24],[27,27,27.7,28.5,29.57,29.95,31.5,32.27,32.95,33.35,34.15,
34.55,35,35,33.9,33.02,33.75,34.15,34.95,32.75]+273);
[apr26,ene116] = theoreticalpowermono(116,23.7,[05 28],[18
24],[27.6,28.07,29.17,29.73,30,30,30.73,32.12,31.93,32.33,33.1
3,33.53,34,34,34.53,34.93,35.73,36.13,35.24,33.8]+273);
[apr27,ene117] = theoreticalpowermono(117,23.7,[05 27],[18
25],[27.12,27.52,28.32,28.72,29.53,29.92,31,31,31,31,31,31,29.
73,28.13,28.03,28.87,30.43,31,31,30.68]+273);
[apr28,ene118] = theoreticalpowermono(118,23.7,[05 27],[18
25],[25.12,25.52,26,26,26.52,26.92,27.52,27.92,28,28.32,29.12,
29.52,30.63,31.43,32.52,32.92,32.38,31.88,31.08,30.78]+273);
[apr29,ene119] = theoreticalpowermono(119,23.7,[05 26],[18
26],[26,26,26.12,26.7,28.03,28.8,29.7,30.08,30.9,31.6,33.1,33.
5,34.13,34.7,35,35,35.7,35.9,35.1,34.1]+273);
[apr30,ene120] = theoreticalpowermono(120,23.7,[05 25],[18
26],[26,26.48,27.28,27.68,28.5,28.88,29.68,30.13,31.77,32.28,3
3.1,33.48,34.28,34.68,35,35,34.42,34,34,33.82]+273);

energy4=
(ene93+ene94+ene95+ene96+ene97+ene99+ene100+ene101+ene102+ene1
03+ene104+ene105+ene106+ene107+ene108+ene109+ene110+ene111+ene
112+ene113+ene114+ene115+ene116+ene117+ene118+ene119+ene120)/2
2;
total4=energy4*30;
Energy4=[ene93,ene94,ene95,ene96,ene97,ene99,ene100,ene101,ene
102,ene103,ene104,ene105,ene106,ene107,ene108,ene109,ene110,en
e111,ene112,ene113,ene114,ene115,ene116,ene117,ene118,ene119,e
ne120];
Apr=[3,4,5,6,7,9,10,11,12,13,14,15,16,17,18,19,20,21,22,23,24,
25,26,27,28,29,30];
%figure()
%plot(Apr,Energy4,'Linewidth',3),title('Energy in
April'),xlabel('April'),ylabel('Energy/Whr')

%

```

```

[may1,ene121] = theoreticalpowermono(121,23.7,[05 25],[18
27],[29,29,29.28,29.68,30,30,30.68,31.1,32.77,33.27,35,35,35,3
5,35.97,36.98,36.62,35.9,35.62,34.82]+273);
[may2,ene122] = theoreticalpowermono(122,23.7,[05 24],[18
27],[29,29,29.26,29.67,30.97,31.73,32.68,33,33,33.27,34.13,34.
93,36,36,36,36,36,35.94,35.13,34.73]+273);
[may3,ene123] = theoreticalpowermono(123,23.7,[05 23],[18
28],[30,30,30.25,30.65,31.47,31.85,32.65,33.07,34.7,35.25,36,3
6,36,36,36,36,35.95,35.25,34.85]+273);
[may4,ene124] = theoreticalpowermono(124,23.7,[05 22],[18
28],[29,29,29,29,29.9,30.67,31.63,32.02,32.83,33.23,34.98,33.5
7,33,33,32.13,31.3,30.47,30,30,29.64]+273);
[may5,ene125] = theoreticalpowermono(125,23.7,[05 22],[18
29],[21.03,21.43,21.77,21.47,21.45,21.83,23.9,25.02,25.83,25.7
,29,29,29.23,29.63,30,30,30,29.94,28.33,27.77]+273);
[may6,ene126] = theoreticalpowermono(126,23.7,[05 21],[18
29],[25,25,25,25,24.57,24.18,22.77,22,21.17,21.23,22,22,22.43,
23.23,24.42,24.83,25,25,25,25]+273);
[may7,ene127] = theoreticalpowermono(127,23.7,[05 21],[18
29],[23,23,23.65,24.85,27.3,28.45,29,29,29.83,29.77,29,29,28.4
5,28.15,26.42,26.83,27.62,28,28,27.57]+273);
[may8,ene128] = theoreticalpowermono(128,23.7,[05 20],[18
30],[27,27.23,28.2,28.6,29.42,29.8,30.6,30.98,31.82,32.22,33,3
3,33,33,32.6,32.18,30,27,27,27.2]+273);
[may9,ene129] = theoreticalpowermono(129,23.7,[05 19],[18
30],[24.98,25.38,26.37,27.17,28,28,28,28,27.2,27,27,27.8,29,29
,29,29,29.58,29.98,30,29.63]+273);
[may10,ene130] = theoreticalpowermono(130,23.7,[05 19],[18
31],[26.98,27.38,28.18,28.58,29.23,29.78,30.58,30.98,31.8,32,3
2,32.4,33.18,33.32,34.38,34.8,34.42,33.02,32.22,32.82]+273);
[may11,ene131] = theoreticalpowermono(131,23.7,[05 18],[18
31],[29,28.63,28.5,29.7,31.38,31.77,32,32,32,32.18,32.97,33.38
,34.17,34.6,34.63,34.22,32.3,31.1,31.77,31.83]+273);
[may12,ene132] = theoreticalpowermono(132,23.7,[05 18],[18
32],[28,27.63,27,27,27.38,27.77,28.57,28.95,29.57,30.27,27.13,
27,27.17,27.6,28.73,29.57,30,30,30,30]+273);
[may16,ene136] = theoreticalpowermono(136,23.7,[05 16],[18
34],[25,25,25,25,25,25,24.47,24.08,24,24,24,24,24,24,24,24,
24,24,24.73,25]+273);
[may17,ene137] = theoreticalpowermono(137,23.7,[05 15],[18
34],[24.98,25.32,26.12,26.52,27.33,27.72,28.52,28.9,29,29.13,2
9.92,30.33,31.12,31.72,32,32,32,32,30.28,31]+273);
[may18,ene138] = theoreticalpowermono(138,23.7,[05 15],[18
35],[26,26.32,27.12,27.52,28.67,29.43,30,30,31.13,32,32,32.33,
33,33,31.73,30.07,28.48,28.02,28.72,28.88]+273);
[may19,ene139] = theoreticalpowermono(139,23.7,[05 15],[18
35],[26,26.63,28.12,28.52,29.67,30.43,31.52,31.9,32.57,33,33,3
3.33,34,34,34.32,34.73,35,35,34.33,33.77]+273);
[may20,ene140] = theoreticalpowermono(140,23.7,[05 14],[18
36],[28.98,29,29.1,29.5,30.32,30.7,31.5,31.88,32,31.77,30.2,28
.73,26,26,26,26,26,26,26.7,27]+273);

```

```

[may21,ene141] = theoreticalpowermono(141,23.7,[05 14],[18
36],[27,27,27.2,27.63,28,28,28.8,29,29,29,29,29,29,29.13,30,30
,29.7,29.27,28.4,28]+273);
[may22,ene142] = theoreticalpowermono(142,23.7,[05 13],[18
37],[24.22,24.32,25.18,25.62,26,26,26,26.28,27,27,27.38,27.82,
27.32,27,27,27,27.68,27.72,28,28]+273);
[may23,ene143] = theoreticalpowermono(143,23.7,[05 13],[18
37],[27,26.1,24,24,24.48,24.97,25,25,25,25,25,26,25,25.12,25.9
8,26.83,28,28,28,28]+273);
[may24,ene144] = theoreticalpowermono(144,23.7,[05 13],[18
38],[24,24,24,24,24.48,24.92,25,25.57,27.17,28.03,29,29,29,29,
29,28.17,26.72,26.28,26,25.98]+273);
[may25,ene145] = theoreticalpowermono(145,23.7,[05 13],[18
38],[27,27,27.18,27.62,28.48,28.92,29,29.23,30,30,30.77,31.63,
32,32,32,32,31.72,31.28,30.42,29.98]+273);
[may26,ene146] = theoreticalpowermono(146,23.7,[05 12],[18
39],[27,27,27.17,27.6,28.47,28.9,29.77,30.22,31.07,31.5,32.36,
32.8,33,33,33,33,33,33,33,33]+273);
[may27,ene147] = theoreticalpowermono(147,23.7,[05 12],[18
39],[28,28.3,29.17,29.6,30.93,31.8,32.77,33,33,33,33,33,29.65,
29.05,29.93,29.4,29.73,28.65,28.57,29]+273);
[may28,ene148] = theoreticalpowermono(148,23.7,[05 12],[18
40],[27,27,27.17,27.6,28.47,28.9,29.77,30.22,31,31,31.37,31.8,
32.67,32.9,32.03,31.6,30.73,30.3,30,30]+273);
[may29,ene149] = theoreticalpowermono(149,23.7,[05 12],[18
40],[28,28,28,28,28,28,28.77,29.43,31,31,31,31,31,30.9,30.03,3
0,30,30,30,30]+273);
[may30,ene150] = theoreticalpowermono(150,23.7,[05 11],[18
40],[26.85,27.28,28.3,29.17,30.45,30.88,29.5,29,29.05,29.48,29
.65,29.22,29,28.95,28.05,28,27.75,27.42,27,27]+273);
[may31,ene151] = theoreticalpowermono(151,23.7,[05 11],[18
41],[27,27,27,27,27.45,27.88,28.75,28.8,27.95,27.52,27,27,27.8
2,28,28,27.23,25.5,24.63,24,24]+273);

```

```

energy5=(ene121+ene122+ene123+ene124+ene125+ene126+ene127+ene1
28+ene129+ene130+ene131+ene132+ene136+ene137+ene138+ene139+ene
140+ene141+ene142+ene143+ene144+ene145+ene146+ene147+ene148+en
e149+ene150+ene151)/28;

```

```

total5=energy5*31;

```

```

Energy5=[ene121,ene122,ene123,ene124,ene125,ene126,ene127,ene1
28,ene129,ene130,ene131,ene132,ene136,ene137,ene138,ene139,ene
140,ene141,ene142,ene143,ene144,ene145,ene146,ene147,ene148,en
e149,ene150,ene151];

```

```

May=[1,2,3,4,5,6,7,8,9,10,11,12,16,17,18,19,20,21,22,23,24,25,
26,27,28,29,30,31];

```

```

%figure()

```

```

%plot(May,Energy5,'Linewidth',3),title('Energy in
May'),xlabel('May'),ylabel('Energy/Whr')

```

```

%
```

```

[june1,ene152] = theoreticalpowermono(152,23.7,[05 11],[18
41],[25,25.57,27.15,27.58,28.9,29.77,30.75,31.18,32.05,32.48,3
3,33,33,33,33,32.62,31.75,31.32,31,31]+273);
[june2,ene153] = theoreticalpowermono(153,23.7,[05 11],[18
42],[28,28,28.15,28.59,29.45,29.89,31.5,32,32.05,32.48,33,33,3
3,33.08,33.95,34.38,34.5,33.63,31.9,31.03]+273);
[june3,ene154] = theoreticalpowermono(154,23.7,[05 11],[18
42],[28.13,28.65,29.15,29.59,30.9,31.77,32.75,33,33.05,33.49,3
4.35,34.79,35,35.09,35.95,36,35.75,35.31,34.45,34.01]+273);
[june4,ene155] = theoreticalpowermono(155,23.7,[05 11],[18
43],[28.15,28.29,29.3,30.17,31,31,31,31.19,32,32,32.35,32.79,3
3.65,34,34,33.61,32,30.26,30.1,30.97]+273);
[june5,ene156] = theoreticalpowermono(156,23.7,[05 11],[18
43],[29.43,29.65,30.15,30.59,31,31,31.75,32.19,33,33,33,33,33,
32.83,31.1,31,31,31,31,31]+273);
[june6,ene157] = theoreticalpowermono(157,23.7,[05 11],[18
43],[27,27.57,29.15,29.59,30.45,30.89,31.75,32,31.95,31.51,31,
31,31.65,32,32,31.23,30,30,30.55,30.99]+273);
[june7,ene158] = theoreticalpowermono(158,23.7,[05 11],[18
44],[27,27,27,27,27.45,27.89,27.25,27,27,27,27,27,27.65,28,28,
28,28,28,28,28]+273);
[june8,ene159] = theoreticalpowermono(159,23.7,[05 11],[18
44],[27.43,27.65,28.15,28.59,29.9,30.77,31.75,32,32.05,32.49,3
3.35,33.79,34,34,34,33.23,31.75,31.31,31,31]+273);
[june9,ene160] = theoreticalpowermono(160,23.7,[05 11],[18
45],[28,28.29,29.15,29.59,30.45,30.89,31.75,32,31.95,31.51,31,
31,31.65,32.17,33.9,34,33.5,32.63,32,32]+273);
[june10,ene161] = theoreticalpowermono(161,23.7,[05 11],[18
45],[28.85,29,29.15,29.59,30,30,30.75,31.19,32,32,32.35,32.79,
33,32.95,32.52,32.3,31.87,31.65,31.22,31]+273);
[june11,ene162] = theoreticalpowermono(162,23.7,[05 11],[18
45],[29,29.43,30.73,31.38,32.45,32.89,33.75,34,34.05,34.49,35,
35,35,35,35,34.61,33.75,33.31,32.45,32.01]+273);
[june12,ene163] = theoreticalpowermono(163,23.7,[05 11],[18
46],[29.15,29,29,29,29.9,30.77,31.75,32.19,33.05,33.49,34,34,3
4,34.09,34.95,34.61,34,34,34,34]+273);
[june13,ene164] = theoreticalpowermono(164,23.7,[05 11],[18
46],[29,29,29,29,29.45,29.89,31.5,32.19,33.05,33.49,34,34,34.6
5,34.91,34.05,33.61,33,33,33,33]+273);
[june14,ene165] = theoreticalpowermono(165,23.7,[05 11],[18
46],[28.15,28.29,29.15,29.59,30,30,30.75,31,31.05,31.49,30.6,2
8.86,28.65,29,29,29.39,30.25,30.69,31,31]+273);
[june15,ene166] = theoreticalpowermono(166,23.7,[05 11],[18
47],[28,28.29,29.15,29.59,30.45,30.89,31,31.19,32.05,32.49,33,
33,33.65,34.09,34.95,34.23,33,33,33,33]+273);
[june16,ene167] = theoreticalpowermono(167,23.7,[05 11],[18
47],[29,29.29,30.15,30.59,31.45,31.89,32,32,32,32,32,32,32.65,
33.09,33.95,34,34,34,33.45,33.01]+273);

```



```

[june17,ene168] = theoreticalpowermono(168,23.7,[05 11],[18
47],[30.15,30.29,31,31,31.27,31.53,32.05,32.31,32.83,33.09,33.
61,33.87,33.35,33,33,33.39,33.75,33.31,33,33]+273);
[june18,ene169] = theoreticalpowermono(169,23.7,[05 12],[18
47],[31,31,31.15,31.59,32.45,32.89,33.5,33.79,34.37,34.66,35,3
5,35.65,36,36,36,35.5,34.63,34,34]+273);
[june19,ene170] = theoreticalpowermono(170,23.7,[05 12],[18
48],[30,30.29,31,31,31,31,31,31,31,31,31,31,31.65,32,32,31.61,
30,30,29.45,29.01]+273);
[june20,ene171] = theoreticalpowermono(171,23.7,[05 12],[18
48],[27,29.29,28.3,29.17,30,30,30.75,31.19,32,32,32.35,32.79,3
1.7,30.91,30.05,30.39,31.25,31.69,31.45,31.01]+273);
[june21,ene172] = theoreticalpowermono(172,23.7,[05 12],[18
48],[29,29.29,30.15,30.59,31.45,31.89,32.75,33.19,34.05,34.49,
35.35,35.79,36,36,36,36,35.75,35.31,34.45,34.01]+273);
[june22,ene173] = theoreticalpowermono(173,23.7,[05 12],[18
48],[27,27,27,27,28.8,30.54,31,31,31.08,31.73,33.03,33.68,34,3
4,34,33.61,32.75,32.31,32,32]+273);
[june23,ene174] = theoreticalpowermono(174,23.7,[05 13],[18
49],[29,29,29.15,29.59,30.9,31.77,32.75,33.19,34,34,34.35,34.7
9,35,35,35,35,34.75,34.31,34,34]+273);
[june24,ene175] = theoreticalpowermono(175,23.7,[05 13],[18
49],[28,28.29,29,29,29.45,29.89,32.25,33,33,33,33,33,33,33.09,
33.95,34.39,34.75,34.31,33.45,33.01]+273);
[june25,ene176] = theoreticalpowermono(176,23.7,[05 13],[18
49],[27,27.29,28.08,28.3,28.73,28.95,29,29,29,29,29,29,29,29.0
9,29.95,29.61,29,29,29,29]+273);
[june26,ene177] = theoreticalpowermono(177,23.7,[05 13],[18
49],[27.85,28,28.15,28.59,29.9,29.77,31,30.81,30.1,30.97,32,32
,30.05,29,29,29,29,29,29,29]+273);
[june27,ene178] = theoreticalpowermono(178,23.7,[05 14],[18
49],[28,28,28,28,28.9,28.77,39,30.37,31.8,30.07,28,28,29.3,29.
91,29.05,29.38,30,30,30,30]+273);
[june28,ene179] = theoreticalpowermono(179,23.7,[05 14],[18
49],[28,28.28,29,29,29.9,29.77,29.75,29,28.95,28.52,28,28,28,2
7.97,27.05,27,27,27,27,27]+273);
[june29,ene180] = theoreticalpowermono(180,23.7,[05 14],[18
49],[26.15,26,27.15,27.59,27,27,27.75,28,28,28,27.65,27.21,27,
27,27,27.77,28.5,27.63,27,27]+273);
[june30,ene181] = theoreticalpowermono(181,23.7,[05 15],[18
49],[27.85,28,28,28,28,28,28.75,29.18,30,30,30,30,30,30,30,30,
30,30,30,30]+273);

```

```

energy6=(ene152+ene153+ene154+ene155+ene156+ene157+ene158+ene1
59+ene160+ene161+ene162+ene163+ene164+ene165+ene166+ene167+ene
168+ene169+ene170+ene171+ene172+ene173+ene174+ene175+ene176+en
e177+ene178+ene179+ene180+ene181)/30;
total6=energy6*30;
Energy6=[ene152,ene153,ene154,ene155,ene156,ene157,ene158,ene1
59,ene160,ene161,ene162,ene163,ene164,ene165,ene166,ene167,ene

```

```

168,ene169,ene170,ene171,ene172,ene173,ene174,ene175,ene176,ene177,ene178,ene179,ene180,ene181];
June=[1,2,3,4,5,6,7,8,9,10,11,12,13,14,15,16,17,18,19,20,21,22,23,24,25,26,27,28,29,30];
%figure()
%plot(June,Energy6,'Linewidth',3),title('Energy in June'),xlabel('June'), ylabel('Energy/Whr')

%

[july1,ene182] = theoreticalpowermono(182,23.7,[05 15],[18 49],[27,27.43,28,28,28.86,29,29,29.43,30.72,31.58,31.58,30,30.86,30,30.86,31.43,31.98,32,31.43,31]+273);
[july2,ene183] = theoreticalpowermono(183,23.7,[05 15],[18 49],[28,28,28,28,28.86,29,30.72,31.15,32.33,32.76,33,33,31.83,29.57,31.86,32.72,34,33.95,32.66,31.8]+273);
[july3,ene184] = theoreticalpowermono(184,23.7,[05 16],[18 49],[28,28.43,29,29,29.86,30,30.28,30.42,30.7,30.84,31.41,31.84,31.96,31.57,31.04,31.47,31.93,31.96,31.04,31]+273);
[july4,ene185] = theoreticalpowermono(185,23.7,[05 16],[18 49],[28,28.43,29.29,29.58,30.87,31.73,29.99,28.69,29.55,29.65,29.85,29.95,29.23,28.66,28.57,28.14,28.49,28.92,28.92,29]+273);
;
[july5,ene186] = theoreticalpowermono(186,23.7,[05 16],[18 49],[27.86,28.07,28.7,28.91,29.55,29.98,30.84,31.27,32.13,32.06,32.86,33.72,33.832,33.888,34,33.584,32.758,32.345,31.502,31.089]+273);
[july6,ene187] = theoreticalpowermono(187,23.7,[05 17],[18 49],[27.96,28.39,29.25,29.68,31.4,31.86,31,31.43,32.29,32.72,32.72,32.29,31.9,31.93,32.02,31.77,31.2,31.1,30.6,29.96]+273);
[july7,ene188] = theoreticalpowermono(188,23.7,[05 17],[18 49],[28,28,28,28,29.72,30.58,32.3,32.73,32.73,31.87,31.87,32.73,33,33,33,33,32.57,32.14,32,31.57]+273);
[july8,ene189] = theoreticalpowermono(189,23.7,[05 17],[18 49],[28,28.21,28.63,28.84,29.91,30.77,31.63,32.06,32.92,32.94,33.39,33.82,34,34,34,34,34,34,33.14,32.71]+273);
[july9,ene190] = theoreticalpowermono(190,23.7,[05 18],[18 49],[29,29.43,30,30,28.28,28,30.6,31,31,31,31.86,32.29,33.15,33,33,33,33,33,33]+273);
[july10,ene191] = theoreticalpowermono(191,23.7,[05 18],[18 49],[29,29.43,30,30,30,30,30.86,31.29,32.15,32,32,32,32.86,32.43,32,32,31.57,31.14,31,31]+273);
[july11,ene192] = theoreticalpowermono(192,23.7,[05 19],[18 49],[28,28,28.43,28.86,30.58,31.44,31,31.86,33,33,33,33,33,33,32.57,32.14,31.57,31.14,31,31]+273);
[july12,ene193] = theoreticalpowermono(193,23.7,[05 19],[18 49],[27,27,27,27,27.86,28.29,28,28.43,29.15,29.58,30.87,31.73,32,32.43,33.29,32.86,32,31.57,30.74,30.28]+273);
[july13,ene194] = theoreticalpowermono(194,23.7,[05 20],[18 48],[27,27.43,27.86,27.43,27,27.43,28,28.86,29.29,28.86,29.29,31.01,30.15,30,30,30,30,30.43,31,31]+273);

```

```

[july14,ene195] = theoreticalpowermono(195,23.7,[05 20],[18
48],[28,28,28.43,28.86,28,28,28.86,29.29,30.58,31.44,32.73,33.
16,33,33,32.9,31.6,30,30,30,30]+273);
[july15,ene196] = theoreticalpowermono(196,23.7,[05 20],[18
48],[29,29,29,29,29.86,30,30,30.43,31.29,31.72,32.58,33.01,33.
87,33.44,31.72,32,32,32,31.14,31]+273);
[july16,ene197] = theoreticalpowermono(197,23.7,[05 21],[18
48],[28,28,28.43,28.86,29,29,29.86,30,30.43,30.86,31.72,32,32.
86,33,32.96,32.53,32,32,31.14,31]+273);
[july17,ene198] = theoreticalpowermono(198,23.7,[05 21],[18
48],[29,28.57,28.14,29,29.43,30,30,30.43,30.86,31.72,32.15,33.
01,33,33,33,33,32.43,31.57,31]+273);
[july18,ene199] = theoreticalpowermono(199,23.7,[05 22],[18
47],[28,28.56,27,27,27,27,28.72,29.58,31.3,30.87,31.43,31.86,3
2.43,32.86,33,33,32.86,32.43,31.14,31]+273);
[july19,ene200] = theoreticalpowermono(200,23.7,[05 22],[18
47],[28,28.43,28.43,28,28.43,28,28.86,29.29,30.15,30,30.43,30.
86,31.72,32,32,31.5,31,31,31,31]+273);
[july20,ene201] = theoreticalpowermono(201,23.7,[05 23],[18
47],[28,28,28.43,28.86,29,29.43,30,30,30,30,31.72,32,33.72,32.
42,30.26,29.4,29,29,29.86,30]+273);
[july21,ene202] = theoreticalpowermono(202,23.7,[05 23],[18
46],[29,29,29.43,29.86,30.72,31.15,32.01,32.44,33.3,33.73,34,3
4,34.86,35,34.57,34.14,33.28,32.85,31.99,32]+273);
[july22,ene203] = theoreticalpowermono(203,23.7,[05 23],[18
46],[28,28.43,28.43,28,28.43,28,28.86,29.29,30.15,30,30.43,30.
86,31.72,32,32,31.5,31,31,31,31]+273);
[july23,ene204] = theoreticalpowermono(204,23.7,[05 24],[18
46],[29,29.43,30,30,31.72,32.15,33.01,33,33.43,33.865,34,34,34
,34,34,34,34,34,33.57]+273);
[july24,ene205] = theoreticalpowermono(205,23.7,[05 24],[18
45],[29,29.43,30.29,30.72,30.96,31.06,31,31,31.43,31.86,32.72,
33.15,33,33.86,35,35,34.57,34.14,33.28,33]+273);
[july25,ene206] = theoreticalpowermono(206,23.7,[05 25],[18
45],[29,28.57,28.57,29,29.86,30,30,30.43,31.29,31.72,32.58,33.
01,33,33,33,33,32.86,32.43,31.14,31]+273);
[july26,ene207] = theoreticalpowermono(207,23.7,[05 25],[18
45],[28,28,28.43,28.86,28.33,28,28,28.43,29,29,29,29,29,29,29.
86,30.29,31.15,30.72,29.86,29.43]+273);
[july27,ene208] = theoreticalpowermono(208,23.7,[05 26],[18
44],[27,27,27,27,28.72,29,29.86,29.43,28.57,28.14,28.14,28.14,
28.14,28.14,28.14,28.14,28.14,28.14,28.14,28.14]+273);
[july28,ene209] = theoreticalpowermono(209,23.7,[05 26],[18
43],[27,27.43,28,28,28,27.14,27,27,27,27,27,28.72,29,29.86,
29.43,29,29,28.57,28.14]+273);
[july29,ene210] = theoreticalpowermono(210,23.7,[05 27],[18
43],[27,27,27.43,27.86,27.86,27.43,28,28,28.43,28.86,29.72,30.
15,31.01,31,31.86,31.43,31,31.43,31.43,31]+273);
[july30,ene211] = theoreticalpowermono(211,23.7,[05 27],[18
42],[28,28,28,28,28.86,29.32,29,29.86,31.58,31,31.43,31.86,32,
32,32,31.44,29.42,30,30,30]+273);

```

```

[july31,ene212] = theoreticalpowermono(212,23.7,[05 27],[18
42],[28,28,28.43,28.86,28.33,28,28,28.43,29,29,29,29,29,29,29.
86,30.29,31.15,30.72,29.86,29.43]+273);

energy7=(ene182+ene183+ene184+ene185+ene186+ene187+ene188+ene1
89+ene190+ene191+ene192+ene193+ene194+ene195+ene196+ene197+ene
198+ene199+ene200+ene201+ene202+ene203+ene204+ene205+ene206+en
e207+ene208+ene209+ene210+ene211+ene212)/31;
total7=energy7*31;
Energy7=[ene182,ene183,ene184,ene185,ene186,ene187,ene188,ene1
89,ene190,ene191,ene192,ene193,ene194,ene195,ene196,ene197,ene
198,ene199,ene200,ene201,ene202,ene203,ene204,ene205,ene206,en
e207,ene208,ene209,ene210,ene211,ene212];
July=[1,2,3,4,5,6,7,8,9,10,11,12,13,14,15,16,17,18,19,20,21,22
,23,24,25,26,27,28,29,30,31];
%figure()
%plot(July,Energy7,'Linewidth',3),title('Energy in
July'),xlabel('July'), ylabel('Energy/Whr');

%

[aug2,ene214] = theoreticalpowermono(214,23.7,[05 28],[18
41],[29,29,29,29,30.04,30.09,30.99,32,32.43,32.86,32.26,33.69,
32.83,33.05,33.91,33.79,33.43,33,32.57,32.14]+273);
[aug3,ene215] = theoreticalpowermono(215,23.7,[05 29],[18
40],[29.05,29.61,30,30,30,30.06,30.97,31,31.15,31.56,32,32,32,
32.06,32.9,33,32.86,32.45,32,32]+273);
[aug4,ene216] = theoreticalpowermono(216,23.7,[05 29],[18
40],[29,29,29.4,29.81,30.63,31,31,31,31,31,31.4,30.81,32,32,32
,31.7,31.13,31.55,32,32]+273);
[aug5,ene217] = theoreticalpowermono(217,23.7,[05 30],[18
39],[29,29,29,29,30.29,31.26,31.9,32.31,33,33,33.4,33.81,34,34
,34,33.4,32,32,31.4,30.57]+273);
[aug6,ene218] = theoreticalpowermono(218,23.7,[05 30],[18
38],[27,27,27,27,27,27,27,27,27.15,27.56,27.6,27.18,27,27,27,2
7,27,27,27.3,27.71]+273);
[aug7,ene219] = theoreticalpowermono(219,23.7,[05 31],[18
37],[27.18,27.58,28.41,28.83,30,30,30,30.33,30.16,30.58,31,31,
31,30.83,29.16,28.85,28,28,28,28]+273);
[aug8,ene220] = theoreticalpowermono(220,23.7,[05 31],[18
37],[28,28,28,28,28.65,29,29,29.33,30,30,30.41,30.83,31,30.83,
29.16,29.63,31,31,30.68,30.26]+273);
[aug9,ene221] = theoreticalpowermono(221,23.7,[05 31],[18
36],[28,28,28.41,28.83,29,29.09,29.99,30.33,31,31,31,31,31.66,
32,32,32,32,32,32,32]+273);
[aug10,ene222] = theoreticalpowermono(222,23.7,[05 32],[18
35],[28,28,28.41,28.83,29,29.09,29.99,30.33,31,31,30.81,32,32,
32,31.7,31.28,31.55,31.96,32,31.73]+273);

```

```

[aug11,ene223] = theoreticalpowermono(223,23.7,[05 32],[18
35],[27,27,27,27,26.31,26.11,26.91,27.73,29,29,29.45,29.86,30.
7,30.88,30.05,30,30,30,30,30]+273);
[aug12,ene224] = theoreticalpowermono(224,23.7,[05 33],[18
34],[27.21,27.61,28,28,28.67,29.11,29.91,30,29.77,29.53,29.45,
29.86,30.7,30.88,30.05,30,30,30,30,30]+273);
[aug13,ene225] = theoreticalpowermono(225,23.7,[05 33],[18
33],[29,29,29,29,30.04,30.09,30.99,32,32.43,32.86,32.26,33.69,
32.83,33.05,33.91,33.79,33.43,33,32.57,32.14]+273);
[aug14,ene226] = theoreticalpowermono(226,23.7,[05 33],[18
32],[27,27,27,27,27.34,28.09,28.94,29,29,29,29.37,29.91,30.61,
30.94,30.07,30,30,30,30,30]+273);
[aug15,ene227] = theoreticalpowermono(227,23.7,[05 34],[18
32],[29,29,29,29,30.04,30.09,30.99,32,32.43,32.86,32.26,33.69,
32.83,33.05,33.91,33.79,33.43,33,32.57,32.14]+273);
[aug16,ene228] = theoreticalpowermono(228,23.7,[05 34],[18
32],[26,26.31,27,27,27,27,27,27,27.41,27.64,28.29,28.91,29,29.
67,30.91,31,31,31,31,31]+273);
[aug17,ene229] = theoreticalpowermono(229,23.7,[05 35],[18
30],[28,28,28,28,28.29,28.91,29.45,29.86,31.2,32.45,32.26,33.6
9,32.83,33.05,33.91,33.79,33.43,33,32.57,32.14]+273);
[aug18,ene230] = theoreticalpowermono(230,23.7,[05 35],[18
29],[29,29,29,29,30.04,30.09,30.99,32,32.43,32.86,32,32,32,32,
32,32,31.77,31.35,30.77,30.65]+273);
[aug19,ene231] = theoreticalpowermono(231,23.7,[05 35],[18
28],[29,29,29,29,30.04,30.09,30.99,30,30,30,30,30,30,30,30.94,
31,31,31,30.5,30.32]+273);
[aug20,ene232] = theoreticalpowermono(232,23.7,[05 36],[18
27],[27,27.43,27.86,27.43,27,27.43,28,28.86,29.29,28.86,29.29,
31.01,30.15,30,30,30,30,30.43,31,31]+273);
[aug21,ene233] = theoreticalpowermono(233,23.7,[05 36],[18
27],[28,28,28.43,28.86,30.58,31.44,31,31.86,33,33,31.86,31.43,
31.43,31.86,32.72,33.15,32.29,31.86,31,31]+273);
[aug22,ene234] = theoreticalpowermono(234,23.7,[05 37],[18
26],[28,28.21,28.63,28.84,29.91,30.77,31.63,32.06,32.92,31.57,
31,31,31,30.77,30.27,30,30,30.43,31,31]+273);
[aug23,ene235] = theoreticalpowermono(235,23.7,[05 37],[18
25],[29,29.43,30,30,30,30,30.86,31.29,32.15,32,32,32,32.86,32.
43,32,32,31.57,31.14,31,31]+273);
[aug24,ene236] = theoreticalpowermono(236,23.7,[05 37],[18
24],[29,29.43,30,30,30,30,30.86,31.29,32.15,32,32,32,32.86,32.
43,32,32,31.57,31.14,31,31]+273);
[aug25,ene237] = theoreticalpowermono(237,23.7,[05 38],[18
23],[28,28.21,28.63,28.84,29.91,30.77,31.63,32.06,32.92,31.57,
31,31,31,30.77,30.27,30,30,30.43,31,31]+273);
[aug26,ene238] = theoreticalpowermono(238,23.7,[05 38],[18
22],[28.43,28.86,29.86,30.72,31.47,32.33,33,33,33.43,31.57,31,
31,31,30.77,30.27,30,30,30.43,29.31,29]+273);
[aug27,ene239] = theoreticalpowermono(239,23.7,[05 38],[18
21],[26,26.55,27.63,27.88,27.21,26,26,26,27,27.31,27.81,27.43,
27,27,26.34,26,26,26,26,26]+273);

```

```

[aug28,ene240] = theoreticalpowermono(240,23.7,[05 39],[18
20],[26,26.55,26,26,26,26.88,27.68,28,28,28.6,28.84,28.63,27.6
3,27.07,26.43,27,27,27.77,27.91,28]+273);
[aug29,ene241] = theoreticalpowermono(241,23.7,[05 39],[18
19],[28,28,28.43,28.86,30.58,31.44,31,31.86,33,33,33,33,33,33,
32.57,32.14,31.57,31.14,31,31]+273);
[aug30,ene242] = theoreticalpowermono(242,23.7,[05 39],[18
18],[28,28.21,28.63,28.84,29.91,30.77,31.63,32.06,32.92,31.57,
31,31,31,30.77,30.27,30,30,30.43,31,31]+273);
[aug31,ene243] = theoreticalpowermono(243,23.7,[05 40],[18
17],[29,29,29.43,29.86,30.72,31.15,32.01,32.44,33.3,33.73,34,3
4,34.86,35,34.57,34.14,33.28,31.77,31.14,31]+273);

```

```

energy8=(ene214+ene215+ene216+ene217+ene218+ene219+ene220+ene2
21+ene222+ene223+ene224+ene225+ene226+ene227+ene228+ene229+ene
230+ene231+ene232+ene233+ene234+ene235+ene236+ene237+ene238+en
e239+ene240+ene241+ene242+ene243)/30;

```

```

total8=energy8*31;

```

```

Energy8=[ene214,ene215,ene216,ene217,ene218,ene219,ene220,ene2
21,ene222,ene223,ene224,ene225,ene226,ene227,ene228,ene229,ene
230,ene231,ene232,ene233,ene234,ene235,ene236,ene237,ene238,en
e239,ene240,ene241,ene242,ene243];

```

```

Aug=[2,3,4,5,6,7,8,9,10,11,12,13,14,15,16,17,18,19,20,21,22,23
,24,25,26,27,28,29,30,31];

```

```

%figure()

```

```

%plot(Aug,Energy8,'Linewidth',3),title('Energy in
August'),xlabel('August'),ylabel('Energy/Whr')

```

```

%

```

```

[sept3,ene246] = theoreticalpowermono(246,23.7,[05 41],[18
14],[28,28,29.17,29.95,30,30.08,30.9,31.17,32,32,32,32,32,32,2
8.87,29.17,30,30,30,30]+273);

```

```

[sept4,ene247] = theoreticalpowermono(247,23.7,[05 41],[18
13],[27,27,27.35,27.88,28,28.1,28.93,29.77,31.27,31.6,32.3,32.
67,33.69,33.96,34,33.91,32.87,32.51,32,32]+273);

```

```

[sept5,ene248] = theoreticalpowermono(248,23.7,[05 41],[18
12],[27,28.13,28.07,27.37,27,27.37,28.93,29.43,32,32,32,32,32,
32,32.77,33,33,32.51,31.77,31.4]+273);

```

```

[sept9,ene252] = theoreticalpowermono(252,23.7,[05 43],[18
08],[27.21,28.2,29.43,29.86,30.72,31.15,31.91,32,31.66,30.77,2
9,29,30.88,31.92,29.56,29,28.87,28.41,28,28]+273);

```

```

[sept10,ene253] = theoreticalpowermono(253,23.7,[05 43],[18
07],[26,26.55,27.63,27.88,27.21,26,26,26,27,27.31,27.81,27.43,
27,27,26.34,26,26,26,26,26]+273);

```

```

[sept11,ene254] = theoreticalpowermono(254,23.7,[05 43],[18
06],[27,27,27.35,27.88,28,28.1,28.93,29.77,31.27,31.6,32.3,32.
67,31.92,30.88,29.68,29.27,28.41,28.06,28.55,28.93]+273);

```

```

[sept14,ene257] = theoreticalpowermono(257,23.7,[05 44],[18
03],[28,28,28.43,28.86,28.33,28,28,28.43,29,29,29,29,29,29,29.
86,30.29,31.15,30.72,29.86,29.43]+273);
[sept15,ene258] = theoreticalpowermono(258,23.7,[05 45],[18
02],[27.35,27.67,30,30,30.67,31,31,31.23,32,32,32.17,32.58,32.
87,32.25,29.86,30.29,31,31,31.06,31]+273);
[sept16,ene259] = theoreticalpowermono(259,23.7,[05 45],[18
01],[28,28,28,28,28.68,29.17,30.62,31.23,32.01,32.24,33.1,33.3
4,32.87,31.98,32.45,32.81,33,33,33,33]+273);
[sept19,ene262] = theoreticalpowermono(262,23.7,[05 46],[17
58],[27,27.43,28.43,28.86,29.58,30.01,31.73,32,32.43,32.86,32.
86,32.43,32.1,32.45,32.11,31.6,32.61,33,33,33]+273);
[sept20,ene263] = theoreticalpowermono(263,23.7,[05 46],[17
57],[29.05,29.61,30,30,30,30.06,30.97,31,31.15,31.56,32,32,32,
32.06,32.9,33,32.86,32.45,32,32]+273);
[sept23,ene266] = theoreticalpowermono(266,23.7,[05 47],[17
54],[28,28,28.43,28.86,29,29,29.86,30,30.43,30.86,31.72,32,32.
86,33,32.96,32.53,32,32,31.14,31]+273);
[sept24,ene267] = theoreticalpowermono(267,23.7,[05 48],[17
53],[28,28,28.43,28.86,30.58,31.44,31,31.86,33,33,33,33,33,33,
32.57,32.14,31.57,31.14,31,31]+273);
[sept25,ene268] = theoreticalpowermono(268,23.7,[05 48],[17
52],[27,27.43,28,28,28.86,29,29,29.43,30.72,31.58,32,32,31.77,
31.57,31.04,31.47,31.93,31.96,31.2,30.77]+273);
[sept28,ene271] = theoreticalpowermono(271,23.7,[05 49],[17
50],[26.55,26.06,26,26,26.88,27.1,28,28,28.6,28.94,28.63,27.88
,27.07,26.55,27,27,27.77,27.88,28,28]+273);
[sept29,ene272] = theoreticalpowermono(272,23.7,[05 49],[17
48],[27.65,28.88,29,29,29,29,29,29,29,29,29,29,29,29,29.33,29.
95,30,29.87,28.23,27.88]+273);
[sept30,ene273] = theoreticalpowermono(273,23.7,[05 50],[17
47],[26.45,26.88,27,27,27,27,27,27,27.15,27.77,29.15,29.52,30,
30,29.56,29.14,29,28.95,28.21,28]+273);

```

```

energy9=(ene246+ene247+ene248+ene252+ene253+ene254+ene257+ene2
58+ene259+ene262+ene263+ene266+ene267+ene268+ene271+ene272+ene
273)/17;

```

```

total9=energy9*30;

```

```

Energy9=[ene246,ene247,ene248,ene252,ene253,ene254,ene257,ene2
58,ene259,ene262,ene263,ene266,ene267,ene268,ene271,ene272,ene
273];

```

```

Sept=[3,4,5,9,10,11,14,15,16,19,20,23,24,25,28,29,30];

```

```

%figure()

```

```

%plot(Sept,Energy9,'Linewidth',3),title('Energy in
September'),xlabel('September'),ylabel('Energy/Whr')

```

```

%
```



```

[oct19,ene292] = theoreticalpowermono(292,23.7,[05 57],[17
29],[26.62,26.98,27.72,28.17,29.63,30,30,30.28,31,31,31.12,31.
48,32,32,32.32,32.68,33,33,31.97,31.23]+273);
[oct20,ene293] = theoreticalpowermono(293,23.7,[05 58],[17
28],[26,26,26.9,27.1,27.83,28.2,28.93,29.3,30.03,30.4,30.73,29
,29.23,29.6,29.67,29.3,29,29,29,29]+273);
[oct21,ene294] = theoreticalpowermono(294,23.7,[05 58],[17
27],[26,26,26,26.2,27.67,28.2,28.93,29,29,29,29,29,29,29,29,29
,28.57,28.2,27.47,27.1]+273);
[oct22,ene295] = theoreticalpowermono(295,23.7,[05 59],[17
27],[26.65,27,27,27.12,27.85,28.22,28.95,29,29,29,29.15,29.52,
30,30,29,27.85,26.55,26.18,25.45,25.08]+273);
[oct23,ene296] = theoreticalpowermono(296,23.7,[05 59],[17
26],[25,25.02,25.75,26,26,26.22,26.95,27,27.05,27.42,28,28,28,
28,28,28,27.55,27.18,27,27]+273);
[oct25,ene298] = theoreticalpowermono(298,23.7,[06 00],[17
24],[26.33,26.03,26.77,27,27,27,27,27,27,27,27,27,27,27,26.65,
26.27,26,26,26,26]+273);
[oct26,ene299] = theoreticalpowermono(299,23.7,[06 01],[17
24],[24.68,25,25,25.15,25.88,26,26,26,26,26,26,26,26,26,26,26,
25.52,25.15,25,25]+273);
[oct27,ene300] = theoreticalpowermono(300,23.7,[06 01],[17
23],[25,25,25,25,25,25.25,25.98,26.7,27.83,27.55,27,27,27,27,2
7.73,28.5,29,29,28.42,28.05]+273);
[oct28,ene301] = theoreticalpowermono(301,23.7,[06 02],[17
22],[24.3,24.07,24.8,25.17,25.9,26.27,27,27.37,28,28,28.2,28.5
7,29.6,30.33,31,31,30.5,30.13,26.4,29.03]+273);
[oct29,ene302] = theoreticalpowermono(302,23.7,[06 02],[17
21],[24.3,24.07,24.8,25.33,26.8,27.27,28,28.37,29.1,29.47,30.2
,30.57,31,31,31,31,30.5,30.13,29.4,29.03]+273);
[oct30,ene303] = theoreticalpowermono(303,23.7,[06 03],[17
21],[24,24.08,24.82,25.18,25.92,26.28,27.02,27.38,28.17,28.97,
30,30,30.32,30.68,30.6,30.22,29.48,29.12,29,29]+273);
[oct31,ene304] = theoreticalpowermono(304,23.7,[06 04],[17
20],[23.23,24,24,24.4,25.87,26.6,28.03,28.4,29.13,29.5,30.23,3
0.6,31.33,31.7,32,32,31.47,31.1,30.37,30]+273);

```

```

energy10=(ene275+ene276+ene277+ene278+ene279+ene280+ene281+ene
282+ene283+ene284+ene285+ene286+ene287+ene288+ene289+ene290+en
e291+ene292+ene293+ene294+ene295+ene296+ene298+ene299+ene300+e
ne301+ene302+ene303+ene304)/29;

```

```
total10=energy10*31;
```

```
Energy10=[ene275,ene276,ene277,ene278,ene279,ene280,ene281,ene
282,ene283,ene284,ene285,ene286,ene287,ene288,ene289,ene290,en
e291,ene292,ene293,ene294,ene295,ene296,ene298,ene299,ene300,e
ne301,ene302,ene303,ene304];

```

```
Oct=[2,3,4,5,6,7,8,9,10,11,12,13,14,15,16,17,18,19,20,21,22,23
,25,26,27,28,29,30,31];

```

```
%figure()
```

```
%plot(Oct,Energy10,'Linewidth',3),title('Energy in
October'),xlabel('October'),ylabel('Energy/Whr')
```

```

[nov1,ene305] = theoreticalpowermono(305,23.7,[06 04],[17
19],[24,24.08,24.78,25.27,26.67,27.18,27.88,28,28,28.28,28.98,
29.33,30.03,30.38,31,31,30.87,30.52,29.82,29.47]+273);
[nov2,ene306] = theoreticalpowermono(306,23.7,[06 05],[17
19],[24,24.1,24.8,25.15,25.85,26.2,26.9,27.25,27.95,28.3,29,29
.7,31,31,30.9,30.55,30,30,26.4,28.4]+273);
[nov3,ene307] = theoreticalpowermono(307,23.7,[06 05],[17
18],[24,24.1,24.8,25.3,26.7,27.2,27.9,28,28,28.3,29,29.35,30,3
0,29.9,29.55,29.85,29.5,27.8,27.45]+273);
[nov4,ene308] = theoreticalpowermono(308,23.7,[06 06],[17
18],[24,24,24,24.17,24.87,25.43,26.83,27.27,27.97,27.32,29.02,
29.37,30,30,29.88,29.53,29,28.48,27.78,27.43]+273);
[nov5,ene309] = theoreticalpowermono(309,23.7,[06 06],[17
17],[24,24.12,24.82,25.17,25.87,26.22,26.92,27.27,27.97,28.32,
28.98,28.63,28,28,28,28,28,28,28]+273);
[nov6,ene310] = theoreticalpowermono(310,23.7,[06 07],[17
17],[23,23.13,23.83,24.18,24.88,25.23,25.93,26,26,26.33,27.03,
27.38,28,28,28.13,28.48,29,29,28.75,28.42]+273);
[nov7,ene311] = theoreticalpowermono(311,23.7,[06 08],[17
16],[23,23.15,23.85,24.2,24.9,25.25,25.95,26,26,26.35,27.05,24
.4,28.1,28.45,29,29,29,29,29,29]+273);
[nov8,ene312] = theoreticalpowermono(312,23.7,[06 08],[17
16],[23,23.15,23.85,25.15,25.85,26.5,27.9,28.5,30,30,30,30,30,
30,30,30,29.85,29.45,28.75,28.4]+273);
[nov9,ene313] = theoreticalpowermono(313,23.7,[06 09],[17
15],[20.37,20.33,21.73,22.43,23.83,24.53,25.93,26.63,28.03,28.
73,30,30,30.12,30.47,30.83,30.48,30,30,29.47,28.77]+273);
[nov10,ene314] = theoreticalpowermono(314,23.7,[06 10],[17
15],[23.83,24,24,24.47,25.87,26.57,27.97,28.33,29,29,29.08,29.
43,30.13,30.48,30.82,30.47,29.93,29.42,28.72,28.37]+273);
[nov11,ene315] = theoreticalpowermono(315,23.7,[06 10],[17
14],[22,22.18,22.88,23.23,24.93,28.13,26.93,27.67,29.03,29.38,
30,30,30,30,30,30,29.94,29.42,28.73,28.37]+273);
[nov12,ene316] = theoreticalpowermono(316,23.7,[06 11],[17
14],[21.37,21.53,22.25,22.6,23.6,24.3,25.37,26.4,26.47,27.17,2
8.45,28.8,29.5,29.85,30,30,28.8,28.1,28.45,28]+273);
[nov13,ene317] = theoreticalpowermono(317,23.7,[06 11],[17
14],[20,20.2,20.9,21.75,23.85,24.3,25,25.7,27.05,24.4,28.1,28.
45,29,29,29,29,28.72,28.4,27.7,27.45]+273);
[nov14,ene318] = theoreticalpowermono(318,23.7,[06 12],[17
13],[18.27,18.43,19.83,21.07,23.87,24.63,26.02,26.37,27.13,27.
83,29,29,29,29,29.22,29.57,29.7,29.38,29,29]+273);
[nov15,ene319] = theoreticalpowermono(319,23.7,[06 13],[17
13],[20,20.23,20.93,21.85,23.95,24.67,26.07,26.77,28.17,28.87,
30,30,30,30,30.23,30.57,31.32,31.63,29.72,29.32]+273);
[nov16,ene320] = theoreticalpowermono(320,23.7,[06 13],[17
13],[22,22.47,23.87,24.28,24.98,25.33,26.03,26.38,27.08,27.43,
28.13,28.48,30,30,30.23,30.58,30.68,30.37,29.43,28.63]+273);

```

```

[nov17,ene321] = theoreticalpowermono(321,23.7,[06 14],[17
12],[20.9,21.25,21.95,22.3,23,23.35,24.02,24.4,25.1,25.45,26.3
,27,28.4,29.07,29.5,28.8,27.67,27.45,26.4,26.6]+273);
[nov18,ene322] = theoreticalpowermono(322,23.7,[06 15],[17
12],[19.08,19.53,20.93,21.95,23.02,23.37,25.03,25.42,26.23,26.
93,28.67,29.03,30,30,30,30,29.5,29.33,28.68,28.28]+273);
[nov19,ene323] = theoreticalpowermono(323,23.7,[06 15],[17
12],[19.17,19.53,20.93,21.95,24.03,24.73,26.03,26.42,27.23,27.
93,29.17,29.52,30.22,30.57,30.47,29.77,29,29,28.68,28.28]+273)
;
[nov20,ene324] = theoreticalpowermono(324,23.7,[06 16],[17
12],[20,20.28,20.98,21.67,23.07,23.77,25.1,25.87,27.27,27.97,2
9,29,29.23,29.58,29.43,28.73,28,28,27.33,26.53]+273);
[nov21,ene325] = theoreticalpowermono(325,23.7,[06 17],[17
11],[20,20.6,22,22.7,25.05,25.4,26.07,26.45,27.15,27.5,28,28,2
8,28,28.3,28.65,28.75,28.3,28,28]+273);
[nov22,ene326] = theoreticalpowermono(326,23.7,[06 18],[17
11],[19,19.95,22.02,22.37,23.07,23.42,24.17,24.93,26.33,27.03,
28,28,28,28,28.32,28.67,28.63,28.28,27.63,27.23]+273);
[nov23,ene327] = theoreticalpowermono(327,23.7,[06 18],[17
11],[19.97,20.32,21.05,22.1,24.13,24.83,26.08,26.47,27.17,27.5
2,28.22,28.57,29.27,29.62,30,30,29.63,29.28,28.63,28.23]+273);
[nov24,ene328] = theoreticalpowermono(328,23.7,[06 19],[17
11],[19,19.33,20.1,21.15,23.17,23.87,25.1,25.48,26.18,26.53,27
.23,27.58,28,28,28,28,27.662,27.27,26.62,26.22]+273);
[nov25,ene329] = theoreticalpowermono(329,23.7,[06 20],[17
11],[20,20.18,21.15,22.2,24.2,24.9,26.23,27,28.2,28.55,29.25,2
9.6,29.7,29.45,29,29,28.2,27.5,26.2,25.4]+273);
[nov26,ene330] = theoreticalpowermono(330,23.7,[06 20],[17
11],[20,20.7,22.1,22.8,24.2,24.9,26.23,27,28,28,28.25,28.6,29.
3,29.65,29.75,29.3,28.6,28.35,27.6,27.2]+273);
[nov27,ene331] = theoreticalpowermono(331,23.7,[06 21],[17
11],[21.02,21.37,22.07,22.42,23.12,23.47,24.27,25.03,26.22,26.
57,27.27,27.61,28.32,28.67,28.63,28.28,27.17,26.47,25.58,25.18
]+273);
[nov30,ene334] = theoreticalpowermono(334,23.7,[06 23],[17
11],[20.05,25.4,21.3,22.35,24.15,24.5,25.33,26.1,27.25,27.6,28
.3,28.65,29,29,29,29,28.1,27.4,26.55,26.15]+273);

energy11=(ene305+ene306+ene307+ene308+ene309+ene310+ene311+ene
312+ene313+ene314+ene315+ene316+ene317+ene318+ene319+ene320+en
e321+ene322+ene323+ene324+ene325+ene326+ene327+ene328+ene329+e
ne330+ene331+ene334)/28;
total11=energy11*30;
Energy11=[ene305,ene306,ene307,ene308,ene309,ene310,ene311,ene
312,ene313,ene314,ene315,ene316,ene317,ene31,ene319,ene320,ene
321,ene322,ene323,ene324,ene325,ene326,ene327,ene328,ene329,en
e330,ene331,ene334];
Nov=[1,2,3,4,5,6,7,8,9,10,11,12,13,14,15,16,17,18,19,20,21,22,
23,24,25,26,27,30];
%figure()

```

```
%plot(Nov,Energy11,'Linewidth',3),title('Energy in  
November'),xlabel('November'),ylabel('Energy/Whr')
```

```
%
```

```
[dec1,ene335] = theoreticalpowermono(335,23.7,[06 24],[17  
11],[20.07,20.4,21.13,21.8,23.13,23.8,25.07,25.4,26.13,26.8,11  
.07,11.4,29.07,29.4,30,30,30,29.93,28.87,28.2]+273);  
[dec2,ene336] = theoreticalpowermono(336,23.7,[06 24],[17  
11],[20.07,20.4,21.07,21.4,22.2,23.2,25.07,25.4,26.07,26.4,27.  
07,27.4,28.07,28.4,29,29,28.93,28.6,27.87,27.2]+273);  
[dec3,ene337] = theoreticalpowermono(337,23.7,[06 25],[17  
11],[20.17,20.83,22.17,22.83,24.08,24.42,25.17,25.83,27.25,28.  
25,30,30,30,30,29.92,29.58,29,29,28.83,28.17]+273);  
[dec4,ene338] = theoreticalpowermono(338,23.7,[06 26],[17  
11],[20.2,20.87,22.2,22.87,24.2,24.87,26.1,26.43,27.1,27.43,28  
.1,28.43,29,29,29.1,29.43,29.8,29.13,27.9,27.67]+273);  
[dec6,ene340] = theoreticalpowermono(340,23.7,[06 27],[17  
11],[20.23,20.9,22.12,22.45,23.23,23.9,25.23,25.9,27.12,27.45,  
28.12,28.45,29,29,29,29,28.77,28.1,27,27]+273);  
[dec7,ene341] = theoreticalpowermono(341,23.7,[06 28],[17  
12],[20.27,20.93,22.13,22.47,23.27,23.93,25.13,25.47,26.13,26.  
47,27.13,27.47,28,28,27.87,27.63,26.87,26.63,25.87,25.63]+273)  
;  
[dec8,ene342] = theoreticalpowermono(342,23.7,[06 28],[17  
12],[20,20,20.23,20.9,22.23,22.9,24.23,24.9,26.13,26.47,27.23,  
27.9,29,29,29,29,28.87,28.63,27.87,27.53]+273);  
[dec9,ene343] = theoreticalpowermono(343,23.7,[06 29],[17  
12],[18.3,18.97,20.3,20.97,24,24,24,24,24.3,24.97,26.15,26.48,  
27,27,27.15,27.48,28.15,28.48,26.85,26.62]+273);  
[dec10,ene344] = theoreticalpowermono(344,23.7,[06 30],[17  
12],[20.17,20.5,21.33,22,23.33,24,25.17,25.5,26.33,27,28.17,28  
.5,29,29,28.83,28.5,27.83,27.5,26.83,26.5]+273);  
[dec11,ene345] = theoreticalpowermono(345,23.7,[06 30],[17  
13],[21.17,21.5,22.17,22.5,23.33,24,25.17,25.5,26.17,26.5,27,2  
7,27.17,27.5,28,28,27.83,27.5,26.83,26.5]+273);  
[dec12,ene346] = theoreticalpowermono(346,23.7,[06 31],[17  
13],[18.18,18.52,19.37,20.03,21.37,22.03,23.18,23.52,24.18,24.  
52,25,25,25.18,25.52,26,26,25.88,25.47,25,25]+273);  
[dec13,ene347] = theoreticalpowermono(347,23.7,[06 32],[17  
13],[16.2,16.53,17.6,18.6,20.2,20.53,23.2,23.53,24.4,25.07,26,  
26,26.2,26.53,27,27,26.8,26.47,25.6,24.93]+273);  
[dec14,ene348] = theoreticalpowermono(348,23.7,[06 32],[17  
14],[17.8,17.43,17.6,18.6,20.4,21.07,22.4,23.07,24.4,25.07,26.  
2,26.53,27,27,26.8,26.47,25.8,25.47,24.8,24.47]+273);  
[dec15,ene349] = theoreticalpowermono(349,23.7,[06 33],[17  
14],[16,16,16.65,17.65,19.43,20.1,21.43,22.1,23.43,24.1,25.43,  
26.1,27,27,26.78,26.45,25.78,25.45,23.78,23.45]+273);  
[dec16,ene350] = theoreticalpowermono(350,23.7,[06 33],[17  
14],[16.22,16.55,17.22,17.55,18.87,20.2,22.43,23.1,24.22,24.55  
,25.22,25.55,26.22,26.55,27,27,26.88,26.45,25.57,24.9]+273);
```

```

[dec17,ene351] = theoreticalpowermono(351,23.7,[06 34],[17
15],[17.47,18.13,19.23,19.57,20.23,20.57,21.23,21.57,22.23,22.
57,23.47,24.13,25.23,25.57,25.77,25.43,24.77,24.43,25,25]+273)
;
[dec18,ene352] = theoreticalpowermono(352,23.7,[06 35],[17
15],[15.25,15.42,17,18.33,20.5,21.17,22.25,22.58,23.5,24.17,25
,25,25.25,25.58,25.75,25.42,25,25,24.75,24.42]+273);
[dec19,ene353] = theoreticalpowermono(353,23.7,[06 35],[17
16],[16.25,16.42,17.5,18.17,19.5,20.17,21.25,21.42,22.5,23.17,
24,24,24.25,24.42,24.75,24.48,24.25,24.42,24.5,23.83]+273);
[dec20,ene354] = theoreticalpowermono(354,23.7,[06 36],[17
16],[15.27,15.6,16.53,17.2,18.53,19.2,20.53,21.2,22.53,23.2,24
.27,24.6,25,25,24.73,24.4,23.73,23.4,23,23]+273);
[dec21,ene355] = theoreticalpowermono(355,23.7,[06 36],[17
17],[19,19,19,19,19,19,19.27,19.6,20.27,20.6,21.53,22.2,23,23,
23.27,23.6,24,24,23.73,23.4]+273);
[dec22,ene356] = theoreticalpowermono(356,23.7,[06 37],[17
17],[18,18,18.28,18.62,19.28,19.62,20.28,20.62,21.28,21.62,22.
28,22.62,23,23,23,23,22.82,22.48,21.82,21.48]+273);
[dec23,ene357] = theoreticalpowermono(357,23.7,[06 37],[17
18],[19.28,19.62,20,20,20.57,21.23,22.57,23.23,24.28,24.62,25,
25,25.28,25.62,26,26,25.43,24.77,23.82,23.48]+273);
[dec24,ene358] = theoreticalpowermono(358,23.7,[06 38],[17
18],[17.7,17.37,17.6,18.27,19.6,20.27,21.6,22.27,23.6,24.27,25
.6,26.27,27,27,27,27,26.7,26.67,25.7,25.67]+273);
[dec25,ene359] = theoreticalpowermono(359,23.7,[06 38],[17
18],[17.3,17.63,18,18,18.3,18.63,19.3,19.63,20.3,20.63,21.6,22
.27,23,23,23,23,22.4,21.73,20.7,20.37]+273);
[dec26,ene360] = theoreticalpowermono(360,23.7,[06 38],[17
19],[15.3,15.63,16,16,16.3,16.63,17.3,17.63,18.6,19.27,20.3,20
.63,21,21,21.3,21.63,22,22,22,22]+273);
[dec27,ene361] = theoreticalpowermono(361,23.7,[06 39],[17
20],[14,14,14,14,14.32,14.65,15.32,15.65,16.32,16.65,17.32,17.
65,18.32,18.65,19.32,19.65,18.68,19.45,19,19]+273);
[dec28,ene362] = theoreticalpowermono(362,23.7,[06 39],[17
20],[15,15,15.32,15.65,16.63,17.3,18.32,18.65,19.32,19.65,20.3
2,20.65,21.63,22.3,23,23,22.78,22.45,19.47,20.7]+273);
[dec29,ene363] = theoreticalpowermono(363,23.7,[06 40],[17
21],[14.33,14.67,15.67,16.33,17,17,17.33,17.67,18.33,18.67,19.
67,20.33,21.33,21.67,22.67,23.33,23.77,23.37,22.77,22.37]+273)
;
[dec30,ene364] = theoreticalpowermono(364,23.7,[06 40],[17
22],[14,14,14.67,15.33,16.67,17.33,18.67,19.33,21,22,23.33,23.
67,24.33,24.67,24.77,24.33,24,24,23.33,22.67]+273);
[dec31,ene365] = theoreticalpowermono(365,23.7,[06 40],[17
22],[13.67,14.33,15,15,15.33,15.67,16.67,16.33,18.33,18.67,19.
67,20.33,21.33,21.67,21.33,21.33,21.33,21.33,21.33,21.77,21.43]+273)
;

```

```

energy12=(ene335+ene336+ene337+ene338+ene340+ene341+ene342+ene
343+ene344+ene345+ene346+ene347+ene348+ene349+ene350+ene351+en
e352+ene353+ene354+ene355+ene356+ene357+ene358+ene359+ene360+e
ne361+ene362+ene363+ene364+ene365)/30;
total12=energy12*31;
Energy12=[ene335,ene336,ene337,ene338,ene340,ene341,ene342,ene
343,ene344,ene345,ene346,ene347,ene348,ene349,ene350,ene351,en
e352,ene353,ene354,ene355,ene356,ene357,ene358,ene359,ene360,e
ne361,ene362,ene363,ene364,ene365];
Dec=[1,2,3,4,6,7,8,9,10,11,12,13,14,15,16,17,18,19,20,21,22,23
,24,25,26,27,28,29,30,31];
%figure()
%plot(Dec,Energy12,'Linewidth',3),title('Energy in
December'),xlabel('December'),ylabel('Energy/Whr')

Month=[1,2,3,4,5,6,7,8,9,10,11,12];
TotalEnergy=[total1,
total2,total3,total4,total5,total6,total7,total8,total9,total11
0,total111,total12];

%figure()
%plot(Month, TotalEnergy, 'Linewidth',3),title('Energy over
the year 2013'),xlabel('Months'),ylabel('Energy/Whr')

%%%%%%%%%%poly calculation starts:

[janp1,enepl1] = theoreticalpowerpoly(1,23.7,[6 41],[17
23],[12,12.03,12.35,12.68,13.35,13.68,14.875,15.708,17.375,18.
208,19.875,20.083,22.375,23.208,24.35,24.68,24.65,24.32,22.65,
22.32]+273);
[janp3,enepl3] = theoreticalpowerpoly(3,23.7,[6 41],[17
24],[16,16.03,16.7,17.37,18.525,19.025,20.025,20.525,21.7,22.3
7,23.35,23.68,24.35,24.68,24.825,24.658,24.325,24.158,23.3,22.
63]+273);
[janp4,enepl4] = theoreticalpowerpoly(4,23.7,[6 42],[17
25],[16.35,16.68,17.7,18.37,19.35,19.68,20.7,21.37,22.7,23.37,
24.35,24.68,25,25,25,25,24.65,24.32,23.97,23.65]+273);
[janp5,enepl5] = theoreticalpowerpoly(5,23.7,[6 42],[17
26],[15.37,15.7,16,16,16.73,17.4,18.73,19.4,20.73,21.4,22.37,2
2.7,23.37,23.7,24.37,24.7,25,25,24.63,24.3]+273);
[janp6,enepl6] = theoreticalpowerpoly(6,23.7,[6 42],[17
26],[15.37,15.7,16,16,16.73,17.4,18.73,19.4,20.37,20.7,21.73,2
2.4,23,23,23,23,22.27,21.6,21,21]+273);

```

```

[janp7, enep7] = theoreticalpowerpoly(7, 23.7, [6 42], [17
27], [14.37, 14.7, 15.37, 15.7, 16, 16, 16.73, 17.4, 18.73, 19.4, 20, 20, 2
0, 20, 20, 20, 20, 19.63, 19.3]+273);
[janp8, enep8] = theoreticalpowerpoly(8, 23.7, [6 42], [17
28], [10, 10.03, 10.37, 10.7, 11.37, 11.7, 13.1, 14.1, 15.37, 15.7, 16.37
, 16.7, 17, 17, 17, 17, 17, 16.97, 15.97]+273);
[janp9, enep9] = theoreticalpowerpoly(9, 23.7, [6 42], [17
29], [8.27, 7.93, 8.1, 9.1, 10.73, 11.4, 12.37, 12.7, 13, 13, 13.37, 13.7,
14.37, 14.7, 15.37, 15.7, 16, 16, 14.63, 14.3]+273);
[janp10, enep10] = theoreticalpowerpoly(10, 23.7, [6 43], [17
29], [7.38, 7.72, 8.38, 8.72, 9.38, 9.72, 10.77, 11.43, 12.77, 13.43, 14.
77, 15.43, 16.38, 16.72, 17.38, 17.72, 17.63, 17.28, 16.62, 16.28]+273)
;
[janp15, enep15] = theoreticalpowerpoly(15, 23.7, [6 43], [17
33], [13.38, 13.72, 14.77, 15.43, 17.15, 18.15, 19.7, 20.43, 21.77, 22.4
3, 25, 25, 25, 25, 25.38, 25.72, 25.62, 25.28, 24.62, 24.28]+273);
[janp18, enep18] = theoreticalpowerpoly(18, 23.7, [6 43], [17
35], [14.38, 14.72, 15.92, 18.58, 20.77, 21.43, 22.38, 22.72, 23.77, 24.
43, 25.77, 26.43, 27.38, 27.72, 28.38, 28.72, 28.23, 27.57, 26.23, 25.57
]+273);
[janp20, enep20] = theoreticalpowerpoly(20, 23.7, [6 42], [17
36], [17, 17, 17.38, 17.72, 18.77, 19.43, 20.38, 20.72, 21.38, 21.72, 22.
38, 22.72, 23.77, 24.43, 25.38, 25.72, 26, 26, 25.23, 24.57]+273);
[janp23, enep23] = theoreticalpowerpoly(23, 23.7, [6 42], [17
39], [15.63, 15.3, 15.73, 16.4, 17.73, 18.4, 19.73, 20.4, 21.73, 22.4, 23
.73, 24.4, 26.1, 27.1, 28, 28, 27.27, 26.6, 25.63, 25.3]+273);
[janp25, enep25] = theoreticalpowerpoly(25, 23.7, [6 41], [17
40], [12, 12, 12.4, 12.74, 14.2, 15.2, 16.4, 16.73, 17.4, 17.73, 19.2, 20.
2, 21.8, 22.47, 23, 23, 23, 22.93, 22.27, 21.93]+273);
[janp27, enep27] = theoreticalpowerpoly(27, 23.7, [6 41], [17
41], [12, 12, 12.4, 12.75, 14.35, 15.4, 16.5, 16.85, 17.55, 17.9, 19.8, 20
.85, 22.3, 23, 23, 23, 23, 22.9, 22.2, 21.85]+273);
[janp29, enep29] = theoreticalpowerpoly(29, 23.7, [6 40], [17
43], [12.65, 12.3, 12.4, 12.75, 14.8, 16.2, 18.5, 19.55, 21.1, 21.8, 23.2
, 23.9, 24.65, 25, 25, 25, 25, 24.9, 24.2, 23.85]+273);
[janp31, enep31] = theoreticalpowerpoly(31, 23.7, [6 40], [17
44], [15.35, 15.7, 16.4, 16.75, 17.45, 17.8, 19, 19.7, 21.65, 22.7, 24.8,
25.85, 26.65, 27, 27.7, 27.95, 27.35, 26.8, 25.4, 23.85]+273);

energyp1=
(enep1+enep3+enep4+enep5+enep6+enep7+enep8+enep9+enep10+enep15
+enep18+enep20+enep23+enep25+enep27+enep29+enep31)/17;
totalp1=energyp1*31;
energyp1=[enep1, enep3, enep4, enep5, enep6, enep7, enep8, enep9, enep
10, enep15, enep18, enep20, enep23, enep25, enep27, enep29, enep31];
janp=[1, 3, 4, 5, 6, 7, 8, 9, 10, 15, 18, 20, 23, 25, 27, 29, 31];

```

⊘

```

[febp1,enep32] = theoreticalpowerpoly(32,23.7,[6 39],[17
45],[15.32,15.67,16.73,17.43,18.83,19.53,20.93,21.63,22,22,23.
13,23.83,23.38,23.03,23,22.98,22.28,22,22,22]+273);
[febp2,enep33] = theoreticalpowerpoly(33,23.7,[6 39],[17
46],[15.32,15.67,16.73,17.43,18.83,19.53,20.93,21.63,23.03,23.
73,25.13,26.08,26.62,26.97,27,26.98,26.28,25.93,25.23,24.88]+2
73);
[febp4,enep35] = theoreticalpowerpoly(35,23.7,[6 38],[17
47],[17.3,17.65,18.7,19.4,20.8,21.5,22.9,23.6,25.5,26.55,27.55
,27.9,28,28,28,28,27.3,26.95,26.25,25.9,]+273);
[febp9,enep40] = theoreticalpowerpoly(40,23.7,[6 35],[17
50],[18.25,18.6,19.3,19.65,21.05,22.1,23.4,23.75,24.45,24.8,26
.1,26.7,27,27,27.6,27.95,27.45,27,26.3,25.95]+273);
[febp13,enep44] = theoreticalpowerpoly(44,23.7,[6 33],[17
53],[19,19,19.53,20.23,21.63,22.33,23.73,24.43,25.83,26.53,28.
03,28.63,29.52,29.87,30,30,30,30,29.33,28.98]+273);
[febp21,enep52] = theoreticalpowerpoly(52,23.7,[6 27],[17
57],[19,19,19.43,20.17,21.63,22.37,23.83,24.57,26.03,26.77,28.
23,28.97,29.72,30,30,30,30,29.72,28.97,28.23]+273);
[febp22,enep53] = theoreticalpowerpoly(53,23.7,[6 26],[17
58],[21.2,21.6,22.1,22.6,23.5,24.6,25.4,25.8,26.5,26.8,27.4,27
.9,28.7,29.5,31.8,31.6,31.2,30.8,30,29.6]+273);
[febp23,enep54] = theoreticalpowerpoly(54,23.7,[6 26],[17
58],[19,19,19.4,20.5,21.5,22.3,24.2,25.3,27,27.73,29.2,29.93,3
1.4,32.13,32,32,32,31.8,31,29.9]+273);
[febp25,enep56] = theoreticalpowerpoly(56,23.7,[6 24],[17
59],[21.1,21.4,22.54,23.8,25.45,26.69,27.2,27.84,28.64,28.89,2
9,29,29.64,30.1,30.79,31.4,31.93,31.5,30.07,29.33]+273);
[febp27,enep58] = theoreticalpowerpoly(58,23.7,[6 22],[18
00],[20,20,20.8,23,26.23,26.6,27.33,28.4,29.43,29.8,30.53,30.9
,31.63,32,32.73,32.53,31.6,30.87,29.7,29.33]+273);
[febp28,enep59] = theoreticalpowerpoly(59,23.7,[6 21],[18
01],[20,20,20.35,21.45,23.65,24.35,25.3,25.79,26.35,27.65,29.0
3,29.77,31.23,31.97,32.72,32.92,32.18,31.82,31.08,30.72]+273);

energyp2=(enep32+enep33+enep35+enep40+enep44+enep52+enep53+ene
p54+enep56+enep58+enep59)/11;
totalp2= energyp2*28;
energyp2=[enep32,enep33,enep35,enep40,enep44,enep52,enep53,ene
p54,enep56,enep58,enep59];
febp =[1,2,4,9,13,21,22,23,25,27,28];

```

⌘

```

[marp1,enep60] = theoreticalpowerpoly(60,23.7,[6 21],[18
01],[20.03,20.38,21.23,21.97,23.43,24.17,25.63,26.37,25.83,26.
57,27.52,27.88,29.62,29.98,30.72,31,31,30.82,30.02,29.43]+273)
;
[marp3,enep62] = theoreticalpowerpoly(62,23.7,[6 19],[18
02],[18.99,19.65,21.33,22.73,24.18,24.55,25.65,26.75,27.72,28.

```



```

63,29.67,30.78,31.665,31.97,32,31.91,31.13,30.98,30.63,29.5]+2
73);
[marp5, enep64] = theoreticalpowerpoly(64,23.7,[6 17],[18
03],[21,21.32,22.15,23.25,25.45,26.55,28.5,29.23,30.35,30.72,3
1.45,31.82,32.55,32.92,33,32.98,32.35,32,32,31.57]+273);
[marp7, enep66] = theoreticalpowerpoly(66,23.7,[6 15],[18
04],[22,22.85,25.05,25.38,26.12,26.48,27.22,27.58,28.32,28.68,
29.83,30.57,32.03,32.77,32.42,32.12,32.28,31.98,31.12,28.63]+2
73);
[marp9, enep68] = theoreticalpowerpoly(68,23.7,[6 13],[18
05],[20,20,20,22.1,26.5,26.9,28.37,29.1,30.28,30.65,31.38,31.7
5,32.48,32.85,33,33,31.28,32,31.53,30.87]+273);
[marp11, enep70] = theoreticalpowerpoly(70,23.7,[6 11],[18
06],[24,24,24,24.35,25,25,25,25,25.35,25.88,27.05,28.5,29.33,2
9.69,31.34,32.98,32,32,31.35,31]+273);
[marp12, enep71] = theoreticalpowerpoly(71,23.7,[6 10],[18
06],[24.8,25.35,25.99,26,26.23,26.57,27.28,27.67,28.43,28.82,2
9.58,29.97,31.47,32.23,30.23,30,29.97,29.58,29,29]+273);
[marp13, enep72] = theoreticalpowerpoly(72,23.7,[6 09],[18
07],[24.88,25.31,25.98,26.23,27.13,28.35,30,30,31.65,31.88,32,
32,31.65,31,31,30.75,29.97,29.2,27.83,27.45]+273);
[marp15, enep74] = theoreticalpowerpoly(74,23.7,[6 08],[18
07],[25.2,25.37,26.9,26.67,29.1,29.48,30.25,30.63,31.4,31.78,3
2.55,32.93,33.7,34,34,34,34,34,33.7,32.93]+273);
[marp16, enep75] = theoreticalpowerpoly(75,23.7,[6 07],[18
08],[25.22,25.17,25.93,26.32,27.08,27.93,29.23,29.62,30.38,30.
77,31.53,31.92,32,32.2,34.5,34.88,34.12,34.27,32,32]+273);
[marp17, enep76] = theoreticalpowerpoly(76,23.7,[6 06],[18
08],[25,25.15,25.92,26.3,27.07,27.9,29.22,29.6,30.37,30.75,31,
31,32.33,33,33,32.8,32.03,30.95,28.65,27.5]+273);
[marp18, enep77] = theoreticalpowerpoly(77,23.7,[6 05],[18
09],[21.35,21.27,22.8,23.57,25.1,25.43,26.4,27.17,28.7,29.47,3
1,31.77,32.65,33,33,33,33,32.33,30.9,30.52]+273);
[marp20, enep79] = theoreticalpowerpoly(79,23.7,[6 03],[18
09],[24.28,24,24,24.5,26.02,26.4,27.17,27.55,28.95,30.1,31.93,
32.7,34.23,35,35,34.85,34.02,34,33.8,32.65]+273);
[marp22, enep81] = theoreticalpowerpoly(81,23.7,[6 01],[18
10],[25,25.06,25.83,26.22,26.98,27.37,28.17,29.03,30.57,31.33,
32,32,32.58,32.97,33,33,33,32.2,29.93,29.17]+273);
[marp23, enep82] = theoreticalpowerpoly(82,23.7,[6 00],[18
11],[24.67,25,25,25.4,26.93,27.9,29,29,27.8,28.95,32,32,32.57,
32.95,32.37,32.9,32.14,31.75,29.99,29.6]+273);
[marp24, enep83] = theoreticalpowerpoly(83,23.7,[05 59],[18
11],[25,25.02,25.76,26.35,28.3,29.22,29.95,30.32,31.05,31.42,3
2,32,32.5,32.62,33.35,33.72,34,33.98,33.02,32.43]+273);
[marp25, enep84] = theoreticalpowerpoly(84,23.7,[05 58],[18
11],[25,25.03,26.6,27.8,28.87,29.8,31.08,31.47,32.47,33.23,34.
3,34.77,35.53,35.92,36,35.93,35.17,34.78,34.02,34]+273);
[marp26, enep85] = theoreticalpowerpoly(85,23.7,[05 57],[18
12],[26.65,27,27.76,28.13,28.95,29.9,32.2,32.45,33.43,34.2,35,
35,35,35,35.67,36.05,36.82,35.8,34.04,33.3]+273);

```

```

[marp27, enep86] = theoreticalpowerpoly(86, 23.7, [05 56], [18
12], [27, 27, 27.75, 28.13, 28.9, 29.57, 31.1, 31.887, 33.4, 33.58, 34.35
, 34.73, 35, 34.73, 34.27, 34, 34, 33.82, 33.04, 32]+273);
[marp29, enep88] = theoreticalpowerpoly(88, 23.7, [05 54], [18
13], [25, 25, 25, 25.2, 26.73, 27.25, 28.03, 28.8, 30, 30, 30.95, 32.1, 33.
93, 34.7, 35.62, 36, 34.47, 34.98, 32.17, 32]+273);
[marp30, enep89] = theoreticalpowerpoly(89, 23.7, [05 53], [18
13], [26.55, 26.93, 27.7, 28.25, 30.55, 31.23, 32, 32, 32, 32, 32, 32, 32, 3
2, 33.8, 34.95, 35, 34.87, 34.1, 33.72]+273);
[marp31, enep90] = theoreticalpowerpoly(90, 23.7, [05 52], [18
14], [26, 26, 26.68, 27, 27, 27.22, 27.98, 28.73, 30.133, 30.52, 31.28, 31
.67, 32, 32, 33.75, 34.9, 35, 35, 33.23, 32.57]+273);

```

```

energyp3=(enep60+enep62+enep64+enep66+enep68+enep70+enep71+ene
p72+enep74+enep75+enep76+enep77+enep79+enep81+enep82+enep83+en
ep84+enep85+enep86+enep88+enep89+enep90)/22;
totalp3=energyp3*31;
energyp3=[enep60, enep62, enep64, enep66, enep68, enep70, enep71, ene
p72, enep74, enep75, enep76, enep77, enep79, enep81, enep82, enep83, en
ep84, enep85, enep86, enep88, enep89, enep90];
marp=[1, 3, 5, 7, 9, 11, 12, 13, 15, 16, 17, 18, 20, 22, 23, 24, 25, 26, 27, 29, 3
0, 31];

```

⌘

```

[aprp3, enep93] = theoreticalpowerpoly(93, 23.7, [05 49], [18
15], [25, 24.72, 24.42, 24.25, 26.65, 27.85, 30.25, 30.48, 31.28, 32.37,
33.48, 33.88, 34.68, 35.08, 35.88, 35.72, 34.83, 34.03, 32.72, 32.42]+2
73);
[aprp4, enep94] = theoreticalpowerpoly(94, 23.7, [05 48], [18
15], [26, 26, 26.65, 27.15, 28.55, 30.5, 32.1, 32.9, 34.25, 34.65, 35.25,
35.65, 36, 36.1, 37.9, 38, 37.95, 37.65, 36.5, 35.7]+273);
[aprp5, enep95] = theoreticalpowerpoly(95, 23.7, [05 47], [18
16], [26, 26, 27.9, 29, 29, 29.23, 30.07, 30.87, 32.47, 33.67, 34.43, 34.8
3, 35, 35, 35, 34.77, 33.97, 33.57, 32.77, 32.37]+273);
[aprp6, enep96] = theoreticalpowerpoly(96, 23.7, [05 46], [18
16], [25.23, 25.87, 27.27, 28.07, 28.83, 29.23, 30.03, 30.43, 31.23, 32.
27, 33.43, 33.83, 34.63, 35.03, 35.83, 36.03, 34.97, 34.47, 33.53, 32.73
]+273);
[aprp7, enep97] = theoreticalpowerpoly(97, 23.7, [05 45], [18
16], [27, 27, 28.23, 28.03, 29.63, 30.43, 32.03, 32.42, 33.22, 33.62, 34,
34, 34, 34.03, 35.63, 36, 35.97, 35.27, 34.43, 33.77]+273);
[aprp9, enep99] = theoreticalpowerpoly(99, 23.7, [05 43], [18
17], [27, 27, 27.58, 27.98, 29.57, 30.37, 31.97, 32.38, 33.37, 34.17, 35.
38, 35.78, 36.58, 36.98, 36.22, 36, 36, 35.62, 34.82, 34.42]+273);
[aprp10, enep100] = theoreticalpowerpoly(100, 23.7, [05 42], [18
18], [27.37, 27.77, 28.57, 28.97, 29, 29.17, 29.97, 30.37, 31.33, 32.13,
33, 33, 34.13, 34.93, 36.13, 37, 37, 36.63, 35.83, 35.43]+273);
[aprp11, enep101] = theoreticalpowerpoly(101, 23.7, [05 41], [18
18], [27, 27, 27.55, 27.95, 28.75, 29.15, 29.95, 30.35, 31.15, 31.55, 32.
7, 33.5, 34.15, 34.95, 35, 34.7, 33.1, 33, 32.85, 32.45]+273);

```

```

[aprp12, enep102] = theoreticalpowerpoly(102, 23.7, [05 40], [18
18], [27.33, 27.73, 29.07, 29.87, 30.73, 31.13, 32.87, 33.67, 35.27, 35.
53, 36.33, 36.73, 37, 37, 37, 36.87, 36.03, 35.77, 34.73, 33.93]+273);
[aprp13, enep103] = theoreticalpowerpoly(103, 23.7, [05 39], [18
19], [26, 26, 28.07, 29.67, 30.72, 31.12, 31.92, 32.32, 33.12, 33.73, 35.
63, 36.43, 37, 37, 37, 37, 37, 36.68, 35.88, 35.48]+273);
[aprp14, enep104] = theoreticalpowerpoly(104, 23.7, [05 38], [18
19], [27.6, 28.4, 29.5, 29.9, 30.7, 31.1, 32.8, 33.6, 35.2, 35.5, 35.7, 35
.3, 34.5, 34.1, 31.9, 30.7, 31.9, 32, 32, 32]+273);
[aprp15, enep105] = theoreticalpowerpoly(105, 23.7, [05 37], [18
20], [26.28, 26.68, 27.48, 27.88, 29.37, 30, 30, 30.28, 31.08, 31.28, 32.
57, 33.37, 34.28, 34.68, 35, 34.92, 34.22, 33.82, 32.98, 32.52]+273);
[aprp16, enep106] = theoreticalpowerpoly(106, 23.7, [05 37], [18
20], [24, 24, 24.48, 24.88, 25.68, 26.08, 27.77, 28.28, 29.08, 29.48, 30,
30, 30, 30, 30.68, 30.92, 30.22, 30, 29.92, 29.62]+273);
[aprp17, enep107] = theoreticalpowerpoly(107, 23.7, [05 36], [18
21], [23, 23, 21.13, 19.53, 19.67, 20.07, 21.73, 22.5, 24.13, 25.4, 27.8,
29, 29.53, 29.12, 29.67, 30, 30, 29.83, 28.93, 28.53]+273);
[aprp18, enep108] = theoreticalpowerpoly(108, 23.7, [05 35], [18
21], [25.25, 25.65, 26, 26, 26.65, 27.05, 27.85, 28.23, 29.05, 29.45, 30.
05, 30.65, 31.45, 31.85, 33, 32.85, 32.15, 31.85, 29.9, 30.1]+273);
[aprp19, enep109] = theoreticalpowerpoly(109, 23.7, [05 34], [18
21], [25.23, 25.63, 26, 26, 27.27, 28.07, 28.83, 29.43, 31.07, 31.43, 32.
23, 32.63, 33, 33, 33.63, 34, 34, 33.87, 32.97, 32.67]+273);
[aprp20, enep110] = theoreticalpowerpoly(110, 23.7, [05 33], [18
22], [22.23, 22.62, 23.83, 24.63, 26.85, 28, 28, 28.2, 29.02, 29.42, 30.2
2, 30.62, 31, 31, 32.23, 33, 33, 32.88, 31.98, 31.88]+273);
[aprp21, enep111] = theoreticalpowerpoly(111, 23.7, [05 32], [18
22], [26, 26, 26.8, 27.6, 28.62, 29, 29.8, 30, 30, 30.4, 31.03, 31.6, 32, 32
, 32, 31.97, 30.4, 30, 30, 29.6]+273);
[aprp22, enep112] = theoreticalpowerpoly(112, 23.7, [05 31], [18
23], [23.18, 23.6, 24, 24, 24.6, 24.98, 24.32, 24.17, 24.98, 25.38, 26.18
, 26.58, 27, 27, 27.58, 28, 28, 28, 28, 28]+273);
[aprp23, enep113] = theoreticalpowerpoly(113, 23.7, [05 31], [18
23], [23.37, 24.17, 25.77, 26.57, 27.6, 27.98, 28.78, 29.17, 29.98, 30.7
7, 32, 32, 32, 32, 31.42, 31, 32.57, 32.73, 31.03, 30.62]+273);
[aprp24, enep114] = theoreticalpowerpoly(114, 23.7, [05 30], [18
23], [24, 24, 24.73, 25.53, 27.17, 27.93, 29.53, 30.3, 31.93, 32.73, 33.8
3, 33.43, 33.73, 34.53, 34.43, 34.02, 33.34, 32.83, 32.04, 32]+273);
[aprp25, enep115] = theoreticalpowerpoly(115, 23.7, [05 29], [18
24], [27, 27, 27.7, 28.5, 29.57, 29.95, 31.5, 32.27, 32.95, 33.35, 34.15,
34.55, 35, 35, 33.9, 33.02, 33.75, 34.15, 34.95, 32.75]+273);
[aprp26, enep116] = theoreticalpowerpoly(116, 23.7, [05 28], [18
24], [27.6, 28.07, 29.17, 29.73, 30, 30, 30.73, 32.12, 31.93, 32.33, 33.1
3, 33.53, 34, 34, 34.53, 34.93, 35.73, 36.13, 35.24, 33.8]+273);
[aprp27, enep117] = theoreticalpowerpoly(117, 23.7, [05 27], [18
25], [27.12, 27.52, 28.32, 28.72, 29.53, 29.92, 31, 31, 31, 31, 31, 31, 29.
73, 28.13, 28.03, 28.87, 30.43, 31, 31, 30.68]+273);
[aprp28, enep118] = theoreticalpowerpoly(118, 23.7, [05 27], [18
25], [25.12, 25.52, 26, 26, 26.52, 26.92, 27.52, 27.92, 28, 28.32, 29.12,
29.52, 30.63, 31.43, 32.52, 32.92, 32.38, 31.88, 31.08, 30.78]+273);

```

```
[aprp29, enep119] = theoreticalpowerpoly(119, 23.7, [05 26], [18
26], [26, 26, 26.12, 26.7, 28.03, 28.8, 29.7, 30.08, 30.9, 31.6, 33.1, 33.
5, 34.13, 34.7, 35, 35, 35.7, 35.9, 35.1, 34.1]+273);
[aprp30, enep120] = theoreticalpowerpoly(120, 23.7, [05 25], [18
26], [26, 26.48, 27.28, 27.68, 28.5, 28.88, 29.68, 30.13, 31.77, 32.28, 3
3.1, 33.48, 34.28, 34.68, 35, 35, 34.42, 34, 34, 33.82]+273);
```

```
energyp4=
```

```
(enep93+enep94+enep95+enep96+enep97+enep99+enep100+enep101+ene
p102+enep103+enep104+enep105+enep106+enep107+enep108+enep109+e
nep110+enep111+enep112+enep113+enep114+enep115+enep116+enep117
+enep118+enep119+enep120)/22;
```

```
totalp4=energyp4*30;
```

```
energyp4=[enep93, enep94, enep95, enep96, enep97, enep99, enep100, en
ep101, enep102, enep103, enep104, enep105, enep106, enep107, enep108,
enep109, enep110, enep111, enep112, enep113, enep114, enep115, enep11
6, enep117, enep118, enep119, enep120];
```

```
aprp=[3, 4, 5, 6, 7, 9, 10, 11, 12, 13, 14, 15, 16, 17, 18, 19, 20, 21, 22, 23, 24
, 25, 26, 27, 28, 29, 30];
```

```
%
```

```
[mayp1, enep121] = theoreticalpowerpoly(121, 23.7, [05 25], [18
27], [29, 29, 29.28, 29.68, 30, 30, 30.68, 31.1, 32.77, 33.27, 35, 35, 35, 3
5, 35.97, 36.98, 36.62, 35.9, 35.62, 34.82]+273);
```

```
[mayp2, enep122] = theoreticalpowerpoly(122, 23.7, [05 24], [18
27], [29, 29, 29.26, 29.67, 30.97, 31.73, 32.68, 33, 33, 33.27, 34.13, 34.
93, 36, 36, 36, 36, 36, 35.94, 35.13, 34.73]+273);
```

```
[mayp3, enep123] = theoreticalpowerpoly(123, 23.7, [05 23], [18
28], [30, 30, 30.25, 30.65, 31.47, 31.85, 32.65, 33.07, 34.7, 35.25, 36, 3
6, 36, 36, 36, 36, 35.95, 35.25, 34.85]+273);
```

```
[mayp4, enep124] = theoreticalpowerpoly(124, 23.7, [05 22], [18
28], [29, 29, 29, 29, 29.9, 30.67, 31.63, 32.02, 32.83, 33.23, 34.98, 33.5
7, 33, 33, 32.13, 31.3, 30.47, 30, 30, 29.64]+273);
```

```
[mayp5, enep125] = theoreticalpowerpoly(125, 23.7, [05 22], [18
29], [21.03, 21.43, 21.77, 21.47, 21.45, 21.83, 23.9, 25.02, 25.83, 25.7
, 29, 29, 29.23, 29.63, 30, 30, 30, 29.94, 28.33, 27.77]+273);
```

```
[mayp6, enep126] = theoreticalpowerpoly(126, 23.7, [05 21], [18
29], [25, 25, 25, 25, 24.57, 24.18, 22.77, 22, 21.17, 21.23, 22, 22, 22.43,
23.23, 24.42, 24.83, 25, 25, 25, 25]+273);
```

```
[mayp7, enep127] = theoreticalpowerpoly(127, 23.7, [05 21], [18
29], [23, 23, 23.65, 24.85, 27.3, 28.45, 29, 29, 29.83, 29.77, 29, 29, 28.4
5, 28.15, 26.42, 26.83, 27.62, 28, 28, 27.57]+273);
```

```
[mayp8, enep128] = theoreticalpowerpoly(128, 23.7, [05 20], [18
30], [27, 27.23, 28.2, 28.6, 29.42, 29.8, 30.6, 30.98, 31.82, 32.22, 33, 3
3, 33, 33, 32.6, 32.18, 30, 27, 27, 27.2]+273);
```

```
[mayp9, enep129] = theoreticalpowerpoly(129, 23.7, [05 19], [18
30], [24.98, 25.38, 26.37, 27.17, 28, 28, 28, 28, 27.2, 27, 27, 27.8, 29, 29
, 29, 29, 29.58, 29.98, 30, 29.63]+273);
```

```

[mayp10, enep130] = theoreticalpowerpoly(130, 23.7, [05 19], [18
31], [26.98, 27.38, 28.18, 28.58, 29.23, 29.78, 30.58, 30.98, 31.8, 32, 3
2, 32.4, 33.18, 33.32, 34.38, 34.8, 34.42, 33.02, 32.22, 32.82]+273);
[mayp11, enep131] = theoreticalpowerpoly(131, 23.7, [05 18], [18
31], [29, 28.63, 28.5, 29.7, 31.38, 31.77, 32, 32, 32, 32.18, 32.97, 33.38
, 34.17, 34.6, 34.63, 34.22, 32.3, 31.1, 31.77, 31.83]+273);
[mayp12, enep132] = theoreticalpowerpoly(132, 23.7, [05 18], [18
32], [28, 27.63, 27, 27, 27.38, 27.77, 28.57, 28.95, 29.57, 30.27, 27.13,
27, 27.17, 27.6, 28.73, 29.57, 30, 30, 30, 30]+273);
[mayp16, enep136] = theoreticalpowerpoly(136, 23.7, [05 16], [18
34], [25, 25, 25, 25, 25, 25, 24.47, 24.08, 24, 24, 24, 24, 24, 24, 24,
24, 24.73, 25]+273);
[mayp17, enep137] = theoreticalpowerpoly(137, 23.7, [05 15], [18
34], [24.98, 25.32, 26.12, 26.52, 27.33, 27.72, 28.52, 28.9, 29, 29.13, 2
9.92, 30.33, 31.12, 31.72, 32, 32, 32, 32, 30.28, 31]+273);
[mayp18, enep138] = theoreticalpowerpoly(138, 23.7, [05 15], [18
35], [26, 26.32, 27.12, 27.52, 28.67, 29.43, 30, 30, 31.13, 32, 32, 32.33,
33, 33, 31.73, 30.07, 28.48, 28.02, 28.72, 28.88]+273);
[mayp19, enep139] = theoreticalpowerpoly(139, 23.7, [05 15], [18
35], [26, 26.63, 28.12, 28.52, 29.67, 30.43, 31.52, 31.9, 32.57, 33, 33, 3
3.33, 34, 34, 34.32, 34.73, 35, 35, 34.33, 33.77]+273);
[mayp20, enep140] = theoreticalpowerpoly(140, 23.7, [05 14], [18
36], [28.98, 29, 29.1, 29.5, 30.32, 30.7, 31.5, 31.88, 32, 31.77, 30.2, 28
.73, 26, 26, 26, 26, 26, 26, 26.7, 27]+273);
[mayp21, enep141] = theoreticalpowerpoly(141, 23.7, [05 14], [18
36], [27, 27, 27.2, 27.63, 28, 28, 28.8, 29, 29, 29, 29, 29, 29, 29.13, 30, 30
, 29.7, 29.27, 28.4, 28]+273);
[mayp22, enep142] = theoreticalpowerpoly(142, 23.7, [05 13], [18
37], [24.22, 24.32, 25.18, 25.62, 26, 26, 26.28, 27, 27, 27.38, 27.82,
27.32, 27, 27, 27, 27.68, 27.72, 28, 28]+273);
[mayp23, enep143] = theoreticalpowerpoly(143, 23.7, [05 13], [18
37], [27, 26.1, 24, 24, 24.48, 24.97, 25, 25, 25, 25, 25, 26, 25, 25.12, 25.9
8, 26.83, 28, 28, 28, 28]+273);
[mayp24, enep144] = theoreticalpowerpoly(144, 23.7, [05 13], [18
38], [24, 24, 24, 24, 24.48, 24.92, 25, 25.57, 27.17, 28.03, 29, 29, 29, 29,
29, 28.17, 26.72, 26.28, 26, 25.98]+273);
[mayp25, enep145] = theoreticalpowerpoly(145, 23.7, [05 13], [18
38], [27, 27, 27.18, 27.62, 28.48, 28.92, 29, 29.23, 30, 30, 30.77, 31.63,
32, 32, 32, 32, 31.72, 31.28, 30.42, 29.98]+273);
[mayp26, enep146] = theoreticalpowerpoly(146, 23.7, [05 12], [18
39], [27, 27, 27.17, 27.6, 28.47, 28.9, 29.77, 30.22, 31.07, 31.5, 32.36,
32.8, 33, 33, 33, 33, 33, 33, 33, 33]+273);
[mayp27, enep147] = theoreticalpowerpoly(147, 23.7, [05 12], [18
39], [28, 28.3, 29.17, 29.6, 30.93, 31.8, 32.77, 33, 33, 33, 33, 33, 29.65,
29.05, 29.93, 29.4, 29.73, 28.65, 28.57, 29]+273);
[mayp28, enep148] = theoreticalpowerpoly(148, 23.7, [05 12], [18
40], [27, 27, 27.17, 27.6, 28.47, 28.9, 29.77, 30.22, 31, 31, 31.37, 31.8,
32.67, 32.9, 32.03, 31.6, 30.73, 30.3, 30, 30]+273);
[mayp29, enep149] = theoreticalpowerpoly(149, 23.7, [05 12], [18
40], [28, 28, 28, 28, 28, 28, 28.77, 29.43, 31, 31, 31, 31, 31, 30.9, 30.03, 3
0, 30, 30, 30, 30]+273);

```

```
[mayp30, enep150] = theoreticalpowerpoly(150, 23.7, [05 11], [18
40], [26.85, 27.28, 28.3, 29.17, 30.45, 30.88, 29.5, 29, 29.05, 29.48, 29
.65, 29.22, 29, 28.95, 28.05, 28, 27.75, 27.42, 27, 27]+273);
[mayp31, enep151] = theoreticalpowerpoly(151, 23.7, [05 11], [18
41], [27, 27, 27, 27, 27.45, 27.88, 28.75, 28.8, 27.95, 27.52, 27, 27, 27.8
2, 28, 28, 27.23, 25.5, 24.63, 24, 24]+273);
```

```
energyp5=(enep121+enep122+enep123+enep124+enep125+enep126+enep
127+enep128+enep129+enep130+enep131+enep132+enep136+enep137+en
ep138+enep139+enep140+enep141+enep142+enep143+enep144+enep145+
enep146+enep147+enep148+enep149+enep150+enep151)/28;
```

```
totalp5=energyp5*31;
```

```
energyp5=[enep121, enep122, enep123, enep124, enep125, enep126, enep
127, enep128, enep129, enep130, enep131, enep132, enep136, enep137, en
ep138, enep139, enep140, enep141, enep142, enep143, enep144, enep145,
enep146, enep147, enep148, enep149, enep150, enep151];
```

```
mayp=[1, 2, 3, 4, 5, 6, 7, 8, 9, 10, 11, 12, 16, 17, 18, 19, 20, 21, 22, 23, 24, 25
, 26, 27, 28, 29, 30, 31];
```

⌘

```
[junep1, enep152] = theoreticalpowerpoly(152, 23.7, [05 11], [18
41], [25, 25.57, 27.15, 27.58, 28.9, 29.77, 30.75, 31.18, 32.05, 32.48, 3
3, 33, 33, 33, 32.62, 31.75, 31.32, 31, 31]+273);
```

```
[junep2, enep153] = theoreticalpowerpoly(153, 23.7, [05 11], [18
42], [28, 28, 28.15, 28.59, 29.45, 29.89, 31.5, 32, 32.05, 32.48, 33, 33, 3
3, 33.08, 33.95, 34.38, 34.5, 33.63, 31.9, 31.03]+273);
```

```
[junep3, enep154] = theoreticalpowerpoly(154, 23.7, [05 11], [18
42], [28.13, 28.65, 29.15, 29.59, 30.9, 31.77, 32.75, 33, 33.05, 33.49, 3
4.35, 34.79, 35, 35.09, 35.95, 36, 35.75, 35.31, 34.45, 34.01]+273);
```

```
[junep4, enep155] = theoreticalpowerpoly(155, 23.7, [05 11], [18
43], [28.15, 28.29, 29.3, 30.17, 31, 31, 31, 31.19, 32, 32, 32.35, 32.79, 3
3.65, 34, 34, 33.61, 32, 30.26, 30.1, 30.97]+273);
```

```
[junep5, enep156] = theoreticalpowerpoly(156, 23.7, [05 11], [18
43], [29.43, 29.65, 30.15, 30.59, 31, 31, 31.75, 32.19, 33, 33, 33, 33, 33,
32.83, 31.1, 31, 31, 31, 31, 31]+273);
```

```
[junep6, enep157] = theoreticalpowerpoly(157, 23.7, [05 11], [18
43], [27, 27.57, 29.15, 29.59, 30.45, 30.89, 31.75, 32, 31.95, 31.51, 31,
31, 31.65, 32, 32, 31.23, 30, 30, 30.55, 30.99]+273);
```

```
[junep7, enep158] = theoreticalpowerpoly(158, 23.7, [05 11], [18
44], [27, 27, 27, 27, 27.45, 27.89, 27.25, 27, 27, 27, 27, 27, 27, 27.65, 28, 28,
28, 28, 28, 28]+273);
```

```
[junep8, enep159] = theoreticalpowerpoly(159, 23.7, [05 11], [18
44], [27.43, 27.65, 28.15, 28.59, 29.9, 30.77, 31.75, 32, 32.05, 32.49, 3
3.35, 33.79, 34, 34, 34, 33.23, 31.75, 31.31, 31, 31]+273);
```

```
[junep9, enep160] = theoreticalpowerpoly(160, 23.7, [05 11], [18
45], [28, 28.29, 29.15, 29.59, 30.45, 30.89, 31.75, 32, 31.95, 31.51, 31,
31, 31.65, 32.17, 33.9, 34, 33.5, 32.63, 32, 32]+273);
```

```

[junep10, enep161] = theoreticalpowerpoly(161,23.7,[05 11],[18
45],[28.85,29,29.15,29.59,30,30,30.75,31.19,32,32,32.35,32.79,
33,32.95,32.52,32.3,31.87,31.65,31.22,31]+273);
[junep11, enep162] = theoreticalpowerpoly(162,23.7,[05 11],[18
45],[29,29.43,30.73,31.38,32.45,32.89,33.75,34,34.05,34.49,35,
35,35,35,34.61,33.75,33.31,32.45,32.01]+273);
[junep12, enep163] = theoreticalpowerpoly(163,23.7,[05 11],[18
46],[29.15,29,29,29,29.9,30.77,31.75,32.19,33.05,33.49,34,34,3
4,34.09,34.95,34.61,34,34,34,34]+273);
[junep13, enep164] = theoreticalpowerpoly(164,23.7,[05 11],[18
46],[29,29,29,29,29.45,29.89,31.5,32.19,33.05,33.49,34,34,34.6
5,34.91,34.05,33.61,33,33,33,33]+273);
[junep14, enep165] = theoreticalpowerpoly(165,23.7,[05 11],[18
46],[28.15,28.29,29.15,29.59,30,30,30.75,31,31.05,31.49,30.6,2
8.86,28.65,29,29,29.39,30.25,30.69,31,31]+273);
[junep15, enep166] = theoreticalpowerpoly(166,23.7,[05 11],[18
47],[28,28.29,29.15,29.59,30.45,30.89,31,31.19,32.05,32.49,33,
33,33.65,34.09,34.95,34.23,33,33,33,33]+273);
[junep16, enep167] = theoreticalpowerpoly(167,23.7,[05 11],[18
47],[29,29.29,30.15,30.59,31.45,31.89,32,32,32,32,32,32,32.65,
33.09,33.95,34,34,34,33.45,33.01]+273);
[junep17, enep168] = theoreticalpowerpoly(168,23.7,[05 11],[18
47],[30.15,30.29,31,31,31.27,31.53,32.05,32.31,32.83,33.09,33.
61,33.87,33.35,33,33,33.39,33.75,33.31,33,33]+273);
[junep18, enep169] = theoreticalpowerpoly(169,23.7,[05 12],[18
47],[31,31,31.15,31.59,32.45,32.89,33.5,33.79,34.37,34.66,35,3
5,35.65,36,36,36,35.5,34.63,34,34]+273);
[junep19, enep170] = theoreticalpowerpoly(170,23.7,[05 12],[18
48],[30,30.29,31,31,31,31,31,31,31,31,31,31,31.65,32,32,31.61,
30,30,29.45,29.01]+273);
[junep20, enep171] = theoreticalpowerpoly(171,23.7,[05 12],[18
48],[27,29.29,28.3,29.17,30,30,30.75,31.19,32,32,32.35,32.79,3
1.7,30.91,30.05,30.39,31.25,31.69,31.45,31.01]+273);
[junep21, enep172] = theoreticalpowerpoly(172,23.7,[05 12],[18
48],[29,29.29,30.15,30.59,31.45,31.89,32.75,33.19,34.05,34.49,
35.35,35.79,36,36,36,36,35.75,35.31,34.45,34.01]+273);
[junep22, enep173] = theoreticalpowerpoly(173,23.7,[05 12],[18
48],[27,27,27,27,28.8,30.54,31,31,31.08,31.73,33.03,33.68,34,3
4,34,33.61,32.75,32.31,32,32]+273);
[junep23, enep174] = theoreticalpowerpoly(174,23.7,[05 13],[18
49],[29,29,29.15,29.59,30.9,31.77,32.75,33.19,34,34,34.35,34.7
9,35,35,35,35,34.75,34.31,34,34]+273);
[junep24, enep175] = theoreticalpowerpoly(175,23.7,[05 13],[18
49],[28,28.29,29,29,29.45,29.89,32.25,33,33,33,33,33,33,33.09,
33.95,34.39,34.75,34.31,33.45,33.01]+273);
[junep25, enep176] = theoreticalpowerpoly(176,23.7,[05 13],[18
49],[27,27.29,28.08,28.3,28.73,28.95,29,29,29,29,29,29,29,29.0
9,29.95,29.61,29,29,29,29]+273);
[junep26, enep177] = theoreticalpowerpoly(177,23.7,[05 13],[18
49],[27.85,28,28.15,28.59,29.9,29.77,31,30.81,30.1,30.97,32,32
,30.05,29,29,29,29,29,29,29]+273);

```

```
[junep27, enep178] = theoreticalpowerpoly(178, 23.7, [05 14], [18
49], [28, 28, 28, 28, 28.9, 28.77, 39, 30.37, 31.8, 30.07, 28, 28, 29.3, 29.
91, 29.05, 29.38, 30, 30, 30, 30]+273);
[junep28, enep179] = theoreticalpowerpoly(179, 23.7, [05 14], [18
49], [28, 28.28, 29, 29, 29.9, 29.77, 29.75, 29, 28.95, 28.52, 28, 28, 28, 2
7.97, 27.05, 27, 27, 27, 27, 27]+273);
[junep29, enep180] = theoreticalpowerpoly(180, 23.7, [05 14], [18
49], [26.15, 26, 27.15, 27.59, 27, 27, 27.75, 28, 28, 28, 27.65, 27.21, 27,
27, 27, 27.77, 28.5, 27.63, 27, 27]+273);
[junep30, enep181] = theoreticalpowerpoly(181, 23.7, [05 15], [18
49], [27.85, 28, 28, 28, 28, 28, 28.75, 29.18, 30, 30, 30, 30, 30, 30, 30,
30, 30, 30, 30]+273);
```

```
energyp6=(enep152+enep153+enep154+enep155+enep156+enep157+enep
158+enep159+enep160+enep161+enep162+enep163+enep164+enep165+en
ep166+enep167+enep168+enep169+enep170+enep171+enep172+enep173+
enep174+enep175+enep176+enep177+enep178+enep179+enep180+enep18
1)/30;
```

```
totalp6=energyp6*30;
```

```
energyp6=[enep152, enep153, enep154, enep155, enep156, enep157, enep
158, enep159, enep160, enep161, enep162, enep163, enep164, enep165, en
ep166, enep167, enep168, enep169, enep170, enep171, enep172, enep173,
enep174, enep175, enep176, enep177, enep178, enep179, enep180, enep18
1];
```

```
junep=[1, 2, 3, 4, 5, 6, 7, 8, 9, 10, 11, 12, 13, 14, 15, 16, 17, 18, 19, 20, 21, 2
2, 23, 24, 25, 26, 27, 28, 29, 30];
```

```
%
```

```
[julyp1, enep182] = theoreticalpowerpoly(182, 23.7, [05 15], [18
49], [27, 27.43, 28, 28, 28.86, 29, 29, 29.43, 30.72, 31.58, 31.58, 30, 30.
86, 30, 30.86, 31.43, 31.98, 32, 31.43, 31]+273);
```

```
[julyp2, enep183] = theoreticalpowerpoly(183, 23.7, [05 15], [18
49], [28, 28, 28, 28, 28.86, 29, 30.72, 31.15, 32.33, 32.76, 33, 33, 31.83,
29.57, 31.86, 32.72, 34, 33.95, 32.66, 31.8]+273);
```

```
[julyp3, enep184] = theoreticalpowerpoly(184, 23.7, [05 16], [18
49], [28, 28.43, 29, 29, 29.86, 30, 30.28, 30.42, 30.7, 30.84, 31.41, 31.8
4, 31.96, 31.57, 31.04, 31.47, 31.93, 31.96, 31.04, 31]+273);
```

```
[julyp4, enep185] = theoreticalpowerpoly(185, 23.7, [05 16], [18
49], [28, 28.43, 29.29, 29.58, 30.87, 31.73, 29.99, 28.69, 29.55, 29.65,
29.85, 29.95, 29.23, 28.66, 28.57, 28.14, 28.49, 28.92, 28.92, 29]+273)
```

```
;
```

```
[julyp5, enep186] = theoreticalpowerpoly(186, 23.7, [05 16], [18
49], [27.86, 28.07, 28.7, 28.91, 29.55, 29.98, 30.84, 31.27, 32.13, 32.0
6, 32.86, 33.72, 33.832, 33.888, 34, 33.584, 32.758, 32.345, 31.502, 31.
089]+273);
```

```
[julyp6, enep187] = theoreticalpowerpoly(187, 23.7, [05 17], [18
49], [27.96, 28.39, 29.25, 29.68, 31.4, 31.86, 31, 31.43, 32.29, 32.72, 3
2.72, 32.29, 31.9, 31.93, 32.02, 31.77, 31.2, 31.1, 30.6, 29.96]+273);
```



```

[julyp7, enep188] = theoreticalpowerpoly(188, 23.7, [05 17], [18
49], [28, 28, 28, 28, 29.72, 30.58, 32.3, 32.73, 32.73, 31.87, 31.87, 32.7
3, 33, 33, 33, 33, 32.57, 32.14, 32, 31.57]+273);
[julyp8, enep189] = theoreticalpowerpoly(189, 23.7, [05 17], [18
49], [28, 28.21, 28.63, 28.84, 29.91, 30.77, 31.63, 32.06, 32.92, 32.94,
33.39, 33.82, 34, 34, 34, 34, 34, 34, 33.14, 32.71]+273);
[julyp9, enep190] = theoreticalpowerpoly(190, 23.7, [05 18], [18
49], [29, 29.43, 30, 30, 28.28, 28, 30.6, 31, 31, 31, 31.86, 32.29, 33.15, 3
3, 33, 33, 33, 33]+273);
[julyp10, enep191] = theoreticalpowerpoly(191, 23.7, [05 18], [18
49], [29, 29.43, 30, 30, 30, 30, 30.86, 31.29, 32.15, 32, 32, 32, 32.86, 32.
43, 32, 32, 31.57, 31.14, 31, 31]+273);
[julyp11, enep192] = theoreticalpowerpoly(192, 23.7, [05 19], [18
49], [28, 28, 28.43, 28.86, 30.58, 31.44, 31, 31.86, 33, 33, 33, 33, 33, 33,
32.57, 32.14, 31.57, 31.14, 31, 31]+273);
[julyp12, enep193] = theoreticalpowerpoly(193, 23.7, [05 19], [18
49], [27, 27, 27, 27, 27.86, 28.29, 28, 28.43, 29.15, 29.58, 30.87, 31.73,
32, 32.43, 33.29, 32.86, 32, 31.57, 30.74, 30.28]+273);
[julyp13, enep194] = theoreticalpowerpoly(194, 23.7, [05 20], [18
48], [27, 27.43, 27.86, 27.43, 27, 27.43, 28, 28.86, 29.29, 28.86, 29.29,
31.01, 30.15, 30, 30, 30, 30, 30.43, 31, 31]+273);
[julyp14, enep195] = theoreticalpowerpoly(195, 23.7, [05 20], [18
48], [28, 28, 28.43, 28.86, 28, 28, 28.86, 29.29, 30.58, 31.44, 32.73, 33.
16, 33, 33, 32.9, 31.6, 30, 30, 30, 30]+273);
[julyp15, enep196] = theoreticalpowerpoly(196, 23.7, [05 20], [18
48], [29, 29, 29, 29, 29.86, 30, 30, 30.43, 31.29, 31.72, 32.58, 33.01, 33.
87, 33.44, 31.72, 32, 32, 32, 31.14, 31]+273);
[julyp16, enep197] = theoreticalpowerpoly(197, 23.7, [05 21], [18
48], [28, 28, 28.43, 28.86, 29, 29, 29.86, 30, 30.43, 30.86, 31.72, 32, 32.
86, 33, 32.96, 32.53, 32, 32, 31.14, 31]+273);
[julyp17, enep198] = theoreticalpowerpoly(198, 23.7, [05 21], [18
48], [29, 28.57, 28.14, 29, 29.43, 30, 30, 30.43, 30.86, 31.72, 32.15, 33.
01, 33, 33, 33, 33, 33, 32.43, 31.57, 31]+273);
[julyp18, enep199] = theoreticalpowerpoly(199, 23.7, [05 22], [18
47], [28, 28.56, 27, 27, 27, 27, 28.72, 29.58, 31.3, 30.87, 31.43, 31.86, 3
2.43, 32.86, 33, 33, 32.86, 32.43, 31.14, 31]+273);
[julyp19, enep200] = theoreticalpowerpoly(200, 23.7, [05 22], [18
47], [28, 28.43, 28.43, 28, 28.43, 28, 28.86, 29.29, 30.15, 30, 30.43, 30.
86, 31.72, 32, 32, 31.5, 31, 31, 31, 31]+273);
[julyp20, enep201] = theoreticalpowerpoly(201, 23.7, [05 23], [18
47], [28, 28, 28.43, 28.86, 29, 29.43, 30, 30, 30, 30, 31.72, 32, 33.72, 32.
42, 30.26, 29.4, 29, 29, 29.86, 30]+273);
[julyp21, enep202] = theoreticalpowerpoly(202, 23.7, [05 23], [18
46], [29, 29, 29.43, 29.86, 30.72, 31.15, 32.01, 32.44, 33.3, 33.73, 34, 3
4, 34.86, 35, 34.57, 34.14, 33.28, 32.85, 31.99, 32]+273);
[julyp22, enep203] = theoreticalpowerpoly(203, 23.7, [05 23], [18
46], [28, 28.43, 28.43, 28, 28.43, 28, 28.86, 29.29, 30.15, 30, 30.43, 30.
86, 31.72, 32, 32, 31.5, 31, 31, 31, 31]+273);
[julyp23, enep204] = theoreticalpowerpoly(204, 23.7, [05 24], [18
46], [29, 29.43, 30, 30, 31.72, 32.15, 33.01, 33, 33.43, 33.865, 34, 34, 34
, 34, 34, 34, 34, 34, 33.57]+273);

```

```

[julyp24, enep205] = theoreticalpowerpoly(205, 23.7, [05 24], [18
45], [29, 29.43, 30.29, 30.72, 30.96, 31.06, 31, 31, 31.43, 31.86, 32.72,
33.15, 33, 33.86, 35, 35, 34.57, 34.14, 33.28, 33]+273);
[julyp25, enep206] = theoreticalpowerpoly(206, 23.7, [05 25], [18
45], [29, 28.57, 28.57, 29, 29.86, 30, 30, 30.43, 31.29, 31.72, 32.58, 33.
01, 33, 33, 33, 33, 32.86, 32.43, 31.14, 31]+273);
[julyp26, enep207] = theoreticalpowerpoly(207, 23.7, [05 25], [18
45], [28, 28, 28.43, 28.86, 28.33, 28, 28, 28.43, 29, 29, 29, 29, 29, 29.
86, 30.29, 31.15, 30.72, 29.86, 29.43]+273);
[julyp27, enep208] = theoreticalpowerpoly(208, 23.7, [05 26], [18
44], [27, 27, 27, 27, 28.72, 29, 29.86, 29.43, 28.57, 28.14, 28.14, 28.14,
28.14, 28.14, 28.14, 28.14, 28.14, 28.14, 28.14]+273);
[julyp28, enep209] = theoreticalpowerpoly(209, 23.7, [05 26], [18
43], [27, 27.43, 28, 28, 28, 28, 27.14, 27, 27, 27, 27, 27, 28.72, 29, 29.86,
29.43, 29, 29, 28.57, 28.14]+273);
[julyp29, enep210] = theoreticalpowerpoly(210, 23.7, [05 27], [18
43], [27, 27, 27.43, 27.86, 27.86, 27.43, 28, 28, 28.43, 28.86, 29.72, 30.
15, 31.01, 31, 31.86, 31.43, 31, 31.43, 31.43, 31]+273);
[julyp30, enep211] = theoreticalpowerpoly(211, 23.7, [05 27], [18
42], [28, 28, 28, 28, 28.86, 29.32, 29, 29.86, 31.58, 31, 31.43, 31.86, 32,
32, 32, 31.44, 29.42, 30, 30, 30]+273);
[julyp31, enep212] = theoreticalpowerpoly(212, 23.7, [05 27], [18
42], [28, 28, 28.43, 28.86, 28.33, 28, 28, 28.43, 29, 29, 29, 29, 29, 29, 29.
86, 30.29, 31.15, 30.72, 29.86, 29.43]+273);

```

```

energyp7=(enep182+enep183+enep184+enep185+enep186+enep187+enep
188+enep189+enep190+enep191+enep192+enep193+enep194+enep195+en
ep196+enep197+enep198+enep199+enep200+enep201+enep202+enep203+
enep204+enep205+enep206+enep207+enep208+enep209+enep210+enep21
1+enep212)/31;

```

```
totalp7=energyp7*31;
```

```

energyp7=[enep182, enep183, enep184, enep185, enep186, enep187, enep
188, enep189, enep190, enep191, enep192, enep193, enep194, enep195, en
ep196, enep197, enep198, enep199, enep200, enep201, enep202, enep203,
enep204, enep205, enep206, enep207, enep208, enep209, enep210, enep21
1, enep212];

```

```

julyp=[1, 2, 3, 4, 5, 6, 7, 8, 9, 10, 11, 12, 13, 14, 15, 16, 17, 18, 19, 20, 21, 2
2, 23, 24, 25, 26, 27, 28, 29, 30, 31];

```

```
%
```

```

[augp2, enep214] = theoreticalpowerpoly(214, 23.7, [05 28], [18
41], [29, 29, 29, 29, 30.04, 30.09, 30.99, 32, 32.43, 32.86, 32.26, 33.69,
32.83, 33.05, 33.91, 33.79, 33.43, 33, 32.57, 32.14]+273);

```

```

[augp3, enep215] = theoreticalpowerpoly(215, 23.7, [05 29], [18
40], [29.05, 29.61, 30, 30, 30, 30.06, 30.97, 31, 31.15, 31.56, 32, 32, 32,
32.06, 32.9, 33, 32.86, 32.45, 32, 32]+273);

```

```

[augp4, enep216] = theoreticalpowerpoly(216, 23.7, [05 29], [18
40], [29, 29, 29.4, 29.81, 30.63, 31, 31, 31, 31, 31, 31.4, 30.81, 32, 32, 32
, 31.7, 31.13, 31.55, 32, 32]+273);

```

```

[augp5, enep217] = theoreticalpowerpoly(217, 23.7, [05 30], [18
39], [29, 29, 29, 29, 30.29, 31.26, 31.9, 32.31, 33, 33, 33.4, 33.81, 34, 34
, 34, 33.4, 32, 32, 31.4, 30.57]+273);
[augp6, enep218] = theoreticalpowerpoly(218, 23.7, [05 30], [18
38], [27, 27, 27, 27, 27, 27, 27, 27, 27.15, 27.56, 27.6, 27.18, 27, 27, 27, 2
7, 27, 27, 27.3, 27.71]+273);
[augp7, enep219] = theoreticalpowerpoly(219, 23.7, [05 31], [18
37], [27.18, 27.58, 28.41, 28.83, 30, 30, 30, 30.33, 30.16, 30.58, 31, 31,
31, 30.83, 29.16, 28.85, 28, 28, 28, 28]+273);
[augp8, enep220] = theoreticalpowerpoly(220, 23.7, [05 31], [18
37], [28, 28, 28, 28, 28.65, 29, 29, 29.33, 30, 30, 30.41, 30.83, 31, 30.83,
29.16, 29.63, 31, 31, 30.68, 30.26]+273);
[augp9, enep221] = theoreticalpowerpoly(221, 23.7, [05 31], [18
36], [28, 28, 28.41, 28.83, 29, 29.09, 29.99, 30.33, 31, 31, 31, 31, 31.66,
32, 32, 32, 32, 32, 32, 32]+273);
[augp10, enep222] = theoreticalpowerpoly(222, 23.7, [05 32], [18
35], [28, 28, 28.41, 28.83, 29, 29.09, 29.99, 30.33, 31, 31, 30.81, 32, 32,
32, 31.7, 31.28, 31.55, 31.96, 32, 31.73]+273);
[augp11, enep223] = theoreticalpowerpoly(223, 23.7, [05 32], [18
35], [27, 27, 27, 27, 26.31, 26.11, 26.91, 27.73, 29, 29, 29.45, 29.86, 30.
7, 30.88, 30.05, 30, 30, 30, 30, 30]+273);
[augp12, enep224] = theoreticalpowerpoly(224, 23.7, [05 33], [18
34], [27.21, 27.61, 28, 28, 28.67, 29.11, 29.91, 30, 29.77, 29.53, 29.45,
29.86, 30.7, 30.88, 30.05, 30, 30, 30, 30, 30]+273);
[augp13, enep225] = theoreticalpowerpoly(225, 23.7, [05 33], [18
33], [29, 29, 29, 29, 30.04, 30.09, 30.99, 32, 32.43, 32.86, 32.26, 33.69,
32.83, 33.05, 33.91, 33.79, 33.43, 33, 32.57, 32.14]+273);
[augp14, enep226] = theoreticalpowerpoly(226, 23.7, [05 33], [18
32], [27, 27, 27, 27, 27.34, 28.09, 28.94, 29, 29, 29, 29.37, 29.91, 30.61,
30.94, 30.07, 30, 30, 30, 30, 30]+273);
[augp15, enep227] = theoreticalpowerpoly(227, 23.7, [05 34], [18
32], [29, 29, 29, 29, 30.04, 30.09, 30.99, 32, 32.43, 32.86, 32.26, 33.69,
32.83, 33.05, 33.91, 33.79, 33.43, 33, 32.57, 32.14]+273);
[augp16, enep228] = theoreticalpowerpoly(228, 23.7, [05 34], [18
32], [26, 26.31, 27, 27, 27, 27, 27, 27, 27.41, 27.64, 28.29, 28.91, 29, 29.
67, 30.91, 31, 31, 31, 31, 31]+273);
[augp17, enep229] = theoreticalpowerpoly(229, 23.7, [05 35], [18
30], [28, 28, 28, 28, 28.29, 28.91, 29.45, 29.86, 31.2, 32.45, 32.26, 33.6
9, 32.83, 33.05, 33.91, 33.79, 33.43, 33, 32.57, 32.14]+273);
[augp18, enep230] = theoreticalpowerpoly(230, 23.7, [05 35], [18
29], [29, 29, 29, 29, 30.04, 30.09, 30.99, 32, 32.43, 32.86, 32, 32, 32, 32,
32, 32, 31.77, 31.35, 30.77, 30.65]+273);
[augp19, enep231] = theoreticalpowerpoly(231, 23.7, [05 35], [18
28], [29, 29, 29, 29, 30.04, 30.09, 30.99, 30, 30, 30, 30, 30, 30, 30, 30.94,
31, 31, 31, 30.5, 30.32]+273);
[augp20, enep232] = theoreticalpowerpoly(232, 23.7, [05 36], [18
27], [27, 27.43, 27.86, 27.43, 27, 27.43, 28, 28.86, 29.29, 28.86, 29.29,
31.01, 30.15, 30, 30, 30, 30, 30.43, 31, 31]+273);
[augp21, enep233] = theoreticalpowerpoly(233, 23.7, [05 36], [18
27], [28, 28, 28.43, 28.86, 30.58, 31.44, 31, 31.86, 33, 33, 31.86, 31.43,
31.43, 31.86, 32.72, 33.15, 32.29, 31.86, 31, 31]+273);

```

```

[augp22, enep234] = theoreticalpowerpoly(234, 23.7, [05 37], [18
26], [28, 28.21, 28.63, 28.84, 29.91, 30.77, 31.63, 32.06, 32.92, 31.57,
31, 31, 31, 30.77, 30.27, 30, 30, 30.43, 31, 31]+273);
[augp23, enep235] = theoreticalpowerpoly(235, 23.7, [05 37], [18
25], [29, 29.43, 30, 30, 30, 30, 30.86, 31.29, 32.15, 32, 32, 32, 32.86, 32.
43, 32, 32, 31.57, 31.14, 31, 31]+273);
[augp24, enep236] = theoreticalpowerpoly(236, 23.7, [05 37], [18
24], [29, 29.43, 30, 30, 30, 30, 30.86, 31.29, 32.15, 32, 32, 32, 32.86, 32.
43, 32, 32, 31.57, 31.14, 31, 31]+273);
[augp25, enep237] = theoreticalpowerpoly(237, 23.7, [05 38], [18
23], [28, 28.21, 28.63, 28.84, 29.91, 30.77, 31.63, 32.06, 32.92, 31.57,
31, 31, 31, 30.77, 30.27, 30, 30, 30.43, 31, 31]+273);
[augp26, enep238] = theoreticalpowerpoly(238, 23.7, [05 38], [18
22], [28.43, 28.86, 29.86, 30.72, 31.47, 32.33, 33, 33, 33.43, 31.57, 31,
31, 31, 30.77, 30.27, 30, 30, 30.43, 29.31, 29]+273);
[augp27, enep239] = theoreticalpowerpoly(239, 23.7, [05 38], [18
21], [26, 26.55, 27.63, 27.88, 27.21, 26, 26, 26, 27, 27.31, 27.81, 27.43,
27, 27, 26.34, 26, 26, 26, 26, 26]+273);
[augp28, enep240] = theoreticalpowerpoly(240, 23.7, [05 39], [18
20], [26, 26.55, 26, 26, 26, 26.88, 27.68, 28, 28, 28.6, 28.84, 28.63, 27.6
3, 27.07, 26.43, 27, 27, 27.77, 27.91, 28]+273);
[augp29, enep241] = theoreticalpowerpoly(241, 23.7, [05 39], [18
19], [28, 28, 28.43, 28.86, 30.58, 31.44, 31, 31.86, 33, 33, 33, 33, 33, 33,
32.57, 32.14, 31.57, 31.14, 31, 31]+273);
[augp30, enep242] = theoreticalpowerpoly(242, 23.7, [05 39], [18
18], [28, 28.21, 28.63, 28.84, 29.91, 30.77, 31.63, 32.06, 32.92, 31.57,
31, 31, 31, 30.77, 30.27, 30, 30, 30.43, 31, 31]+273);
[augp31, enep243] = theoreticalpowerpoly(243, 23.7, [05 40], [18
17], [29, 29, 29.43, 29.86, 30.72, 31.15, 32.01, 32.44, 33.3, 33.73, 34, 3
4, 34.86, 35, 34.57, 34.14, 33.28, 31.77, 31.14, 31]+273);

```

```

energyp8=(enep214+enep215+enep216+enep217+enep218+enep219+enep
220+enep221+enep222+enep223+enep224+enep225+enep226+enep227+en
ep228+enep229+enep230+enep231+enep232+enep233+enep234+enep235+
enep236+enep237+enep238+enep239+enep240+enep241+enep242+enep24
3)/30;
totalp8=energyp8*31;
energyp8=[enep214, enep215, enep216, enep217, enep218, enep219, enep
220, enep221, enep222, enep223, enep224, enep225, enep226, enep227, en
ep228, enep229, enep230, enep231, enep232, enep233, enep234, enep235,
enep236, enep237, enep238, enep239, enep240, enep241, enep242, enep24
3];
augp=[2, 3, 4, 5, 6, 7, 8, 9, 10, 11, 12, 13, 14, 15, 16, 17, 18, 19, 20, 21, 22, 2
3, 24, 25, 26, 27, 28, 29, 30, 31];

```

⊘

```

[seftp3, enep246] = theoreticalpowerpoly(246, 23.7, [05 41], [18
14], [28, 28, 29.17, 29.95, 30, 30.08, 30.9, 31.17, 32, 32, 32, 32, 32, 32, 2
8.87, 29.17, 30, 30, 30, 30]+273);
[seftp4, enep247] = theoreticalpowerpoly(247, 23.7, [05 41], [18
13], [27, 27, 27.35, 27.88, 28, 28.1, 28.93, 29.77, 31.27, 31.6, 32.3, 32.
67, 33.69, 33.96, 34, 33.91, 32.87, 32.51, 32, 32]+273);
[seftp5, enep248] = theoreticalpowerpoly(248, 23.7, [05 41], [18
12], [27, 28.13, 28.07, 27.37, 27, 27.37, 28.93, 29.43, 32, 32, 32, 32, 32,
32, 32.77, 33, 33, 32.51, 31.77, 31.4]+273);
[seftp9, enep252] = theoreticalpowerpoly(252, 23.7, [05 43], [18
08], [27.21, 28.2, 29.43, 29.86, 30.72, 31.15, 31.91, 32, 31.66, 30.77, 2
9, 29, 30.88, 31.92, 29.56, 29, 28.87, 28.41, 28, 28]+273);
[seftp10, enep253] = theoreticalpowerpoly(253, 23.7, [05 43], [18
07], [26, 26.55, 27.63, 27.88, 27.21, 26, 26, 26, 27, 27.31, 27.81, 27.43,
27, 27, 26.34, 26, 26, 26, 26, 26]+273);
[seftp11, enep254] = theoreticalpowerpoly(254, 23.7, [05 43], [18
06], [27, 27, 27.35, 27.88, 28, 28.1, 28.93, 29.77, 31.27, 31.6, 32.3, 32.
67, 31.92, 30.88, 29.68, 29.27, 28.41, 28.06, 28.55, 28.93]+273);
[seftp14, enep257] = theoreticalpowerpoly(257, 23.7, [05 44], [18
03], [28, 28, 28.43, 28.86, 28.33, 28, 28, 28.43, 29, 29, 29, 29, 29, 29, 29.
86, 30.29, 31.15, 30.72, 29.86, 29.43]+273);
[seftp15, enep258] = theoreticalpowerpoly(258, 23.7, [05 45], [18
02], [27.35, 27.67, 30, 30, 30.67, 31, 31, 31.23, 32, 32, 32.17, 32.58, 32.
87, 32.25, 29.86, 30.29, 31, 31, 31.06, 31]+273);
[seftp16, enep259] = theoreticalpowerpoly(259, 23.7, [05 45], [18
01], [28, 28, 28, 28, 28.68, 29.17, 30.62, 31.23, 32.01, 32.24, 33.1, 33.3
4, 32.87, 31.98, 32.45, 32.81, 33, 33, 33, 33]+273);
[seftp19, enep262] = theoreticalpowerpoly(262, 23.7, [05 46], [17
58], [27, 27.43, 28.43, 28.86, 29.58, 30.01, 31.73, 32, 32.43, 32.86, 32.
86, 32.43, 32.1, 32.45, 32.11, 31.6, 32.61, 33, 33, 33]+273);
[seftp20, enep263] = theoreticalpowerpoly(263, 23.7, [05 46], [17
57], [29.05, 29.61, 30, 30, 30, 30, 30.06, 30.97, 31, 31.15, 31.56, 32, 32, 32,
32.06, 32.9, 33, 32.86, 32.45, 32, 32]+273);
[seftp23, enep266] = theoreticalpowerpoly(266, 23.7, [05 47], [17
54], [28, 28, 28.43, 28.86, 29, 29, 29.86, 30, 30.43, 30.86, 31.72, 32, 32.
86, 33, 32.96, 32.53, 32, 32, 31.14, 31]+273);
[seftp24, enep267] = theoreticalpowerpoly(267, 23.7, [05 48], [17
53], [28, 28, 28.43, 28.86, 30.58, 31.44, 31, 31.86, 33, 33, 33, 33, 33, 33,
32.57, 32.14, 31.57, 31.14, 31, 31]+273);
[seftp25, enep268] = theoreticalpowerpoly(268, 23.7, [05 48], [17
52], [27, 27.43, 28, 28, 28.86, 29, 29, 29.43, 30.72, 31.58, 32, 32, 31.77,
31.57, 31.04, 31.47, 31.93, 31.96, 31.2, 30.77]+273);
[seftp28, enep271] = theoreticalpowerpoly(271, 23.7, [05 49], [17
50], [26.55, 26.06, 26, 26, 26.88, 27.1, 28, 28, 28.6, 28.94, 28.63, 27.88
, 27.07, 26.55, 27, 27, 27.77, 27.88, 28, 28]+273);
[seftp29, enep272] = theoreticalpowerpoly(272, 23.7, [05 49], [17
48], [27.65, 28.88, 29, 29, 29, 29, 29, 29, 29, 29, 29, 29, 29, 29, 29, 29.33, 29.
95, 30, 29.87, 28.23, 27.88]+273);
[seftp30, enep273] = theoreticalpowerpoly(273, 23.7, [05 50], [17
47], [26.45, 26.88, 27, 27, 27, 27, 27, 27, 27.15, 27.77, 29.15, 29.52, 30,
30, 29.56, 29.14, 29, 28.95, 28.21, 28]+273);

```

```

energyp9=(enep246+enep247+enep248+enep252+enep253+enep254+enep
257+enep258+enep259+enep262+enep263+enep266+enep267+enep268+en
ep271+enep272+enep273)/17;
totalp9=energyp9*30;
energyp9=[enep246,enep247,enep248,enep252,enep253,enep254,enep
257,enep258,enep259,enep262,enep263,enep266,enep267,enep268,en
ep271,enep272,enep273];
septp=[3,4,5,9,10,11,14,15,16,19,20,23,24,25,28,29,30];

```

⌘

```

[octp2,enep275] = theoreticalpowerpoly(275,23.7,[05 50],[17
45],[28,28,28.65,29.03,29.8,30.18,30.95,31,31.3,32.45,34,34,34
.4,34.78,34.45,34.07,34,33.92,33.15,32.53]+273);
[octp3,enep276] = theoreticalpowerpoly(276,23.7,[05 51],[17
41],[27,27,27.67,28.05,28.82,29,29,29.35,30.12,30.5,31.53,32.3
,32.17,29.4,29.3,28.15,28.72,29.1,29.87,30]+273);
[octp4,enep277] = theoreticalpowerpoly(277,23.7,[05 51],[17
43],[26,26,26.67,27,27,27,27,27,27,27,27,27,27,27,27,27,27,27,27,27,27]+273);
[octp5,enep278] = theoreticalpowerpoly(278,23.7,[05 52],[17
42],[25,25,25.68,26,26,26,26,26.37,27,27,27.28,27.67,28.43,28.
82,29,29,29,29,29,29]+273);
[octp6,enep279] = theoreticalpowerpoly(279,23.7,[05 52],[17
41],[27,27,27,27,27,27,27,27,27.37,28,28,28.28,28.67,29,29,27.83,
27.07,27.73,27.88,27.12,27]+273);
[octp7,enep280] = theoreticalpowerpoly(280,23.7,[05 52],[17
40],[25,25,25.68,26,26,26.22,26.98,27.37,28.13,28.52,29.28,29.
67,30.43,30.82,30.42,30.03,30,30,30,29.47]+273);
[octp8,enep281] = theoreticalpowerpoly(281,23.7,[05 53],[17
39],[27,27,27.7,28.08,28.85,29.23,30,30.38,31,31,31.3,31.68,32
,32,32,30.5,29.65,27.3,27]+273);
[octp9,enep282] = theoreticalpowerpoly(282,23.7,[05 53],[17
38],[26.55,26.93,27.7,28,28,28.23,29,29.38,30.15,30.53,31.3,31
.58,32,32,32,32,30.25,30.87,30.1,30]+273);
[octp10,enep283] = theoreticalpowerpoly(283,23.7,[05 53],[17
37],[26.55,26.93,27.7,28.08,28.85,29.23,30,30.22,31.15,31.53,3
2.3,32.68,33,33,32.4,32.02,32.75,32.87,32.1,32]+273);
[octp11,enep284] = theoreticalpowerpoly(284,23.7,[05 54],[17
36],[27,27,27.67,28.07,29.53,30.27,31.73,32.23,32.97,33.33,33.
93,33.57,33,33,33,33,33,33,32.53,32.17]+273);
[octp12,enep285] = theoreticalpowerpoly(285,23.7,[05 54],[17
35],[27.57,27.93,28.67,29.03,29.77,30.13,30.87,31.23,31.97,32.
33,33,33,33,33,33.27,32.63,33.63,33.27,32.53,32.17]+273);
[octp13,enep286] = theoreticalpowerpoly(286,23.7,[05 55],[17
34],[27.58,27.95,28,28,28,28,28.25,28.98,29.35,30.08,30.45,
31.18,31.55,32,32,32,32,31.03,30.3]+273);

```

```

[octp14, enep287] = theoreticalpowerpoly(287, 23.7, [05 55], [17
33], [27.58, 27.95, 28, 28.1, 29.57, 30.15, 30.88, 31, 31, 31.35, 32, 32, 3
2, 32, 32, 32, 32, 31.52, 31.15]+273);
[octp15, enep288] = theoreticalpowerpoly(288, 23.7, [05 56], [17
32], [26.6, 26.97, 28.4, 29.07, 29.8, 30.17, 30.9, 31.27, 32, 32.37, 32.9
, 32.53, 32, 32, 31.7, 31.33, 30.6, 30.23, 28.5, 27.4]+273);
[octp16, enep289] = theoreticalpowerpoly(289, 23.7, [05 56], [17
32], [26, 26, 26.7, 27.07, 27.8, 28.17, 28.9, 29.27, 30, 30, 30, 30, 30, 30,
30, 30, 30, 30, 29, 28.27]+273);
[octp17, enep290] = theoreticalpowerpoly(290, 23.7, [05 56], [17
31], [26.6, 26.97, 27.7, 28.07, 28.8, 29.17, 29.9, 30.27, 31, 31, 31.1, 31
.47, 32, 32, 31.7, 31.33, 30.6, 30.23, 30, 30]+273);
[octp18, enep291] = theoreticalpowerpoly(291, 23.7, [05 57], [17
30], [27, 27, 27.72, 28.08, 28.82, 29.37, 30.83, 31.28, 32, 32, 32, 32, 32,
32, 32, 32, 31.58, 31.22, 31, 31]+273);
[octp19, enep292] = theoreticalpowerpoly(292, 23.7, [05 57], [17
29], [26.62, 26.98, 27.72, 28.17, 29.63, 30, 30, 30.28, 31, 31, 31.12, 31.
48, 32, 32, 32.32, 32.68, 33, 33, 31.97, 31.23]+273);
[octp20, enep293] = theoreticalpowerpoly(293, 23.7, [05 58], [17
28], [26, 26, 26.9, 27.1, 27.83, 28.2, 28.93, 29.3, 30.03, 30.4, 30.73, 29
, 29.23, 29.6, 29.67, 29.3, 29, 29, 29, 29]+273);
[octp21, enep294] = theoreticalpowerpoly(294, 23.7, [05 58], [17
27], [26, 26, 26, 26.2, 27.67, 28.2, 28.93, 29, 29, 29, 29, 29, 29, 29, 29, 29
, 28.57, 28.2, 27.47, 27.1]+273);
[octp22, enep295] = theoreticalpowerpoly(295, 23.7, [05 59], [17
27], [26.65, 27, 27, 27.12, 27.85, 28.22, 28.95, 29, 29, 29, 29.15, 29.52,
30, 30, 29, 27.85, 26.55, 26.18, 25.45, 25.08]+273);
[octp23, enep296] = theoreticalpowerpoly(296, 23.7, [05 59], [17
26], [25, 25.02, 25.75, 26, 26, 26.22, 26.95, 27, 27.05, 27.42, 28, 28, 28,
28, 28, 28, 27.55, 27.18, 27, 27]+273);
[octp25, enep298] = theoreticalpowerpoly(298, 23.7, [06 00], [17
24], [26.33, 26.03, 26.77, 27, 27, 27, 27, 27, 27, 27, 27, 27, 27, 27, 26.65,
26.27, 26, 26, 26, 26]+273);
[octp26, enep299] = theoreticalpowerpoly(299, 23.7, [06 01], [17
24], [24.68, 25, 25, 25.15, 25.88, 26, 26, 26, 26, 26, 26, 26, 26, 26, 26, 26,
25.52, 25.15, 25, 25]+273);
[octp27, enep300] = theoreticalpowerpoly(300, 23.7, [06 01], [17
23], [25, 25, 25, 25, 25, 25.25, 25.98, 26.7, 27.83, 27.55, 27, 27, 27, 27, 2
7.73, 28.5, 29, 29, 28.42, 28.05]+273);
[octp28, enep301] = theoreticalpowerpoly(301, 23.7, [06 02], [17
22], [24.3, 24.07, 24.8, 25.17, 25.9, 26.27, 27, 27.37, 28, 28, 28.2, 28.5
7, 29.6, 30.33, 31, 31, 30.5, 30.13, 26.4, 29.03]+273);
[octp29, enep302] = theoreticalpowerpoly(302, 23.7, [06 02], [17
21], [24.3, 24.07, 24.8, 25.33, 26.8, 27.27, 28, 28.37, 29.1, 29.47, 30.2
, 30.57, 31, 31, 31, 31, 30.5, 30.13, 29.4, 29.03]+273);
[octp30, enep303] = theoreticalpowerpoly(303, 23.7, [06 03], [17
21], [24, 24.08, 24.82, 25.18, 25.92, 26.28, 27.02, 27.38, 28.17, 28.97,
30, 30, 30.32, 30.68, 30.6, 30.22, 29.48, 29.12, 29, 29]+273);
[octp31, enep304] = theoreticalpowerpoly(304, 23.7, [06 04], [17
20], [23.23, 24, 24, 24.4, 25.87, 26.6, 28.03, 28.4, 29.13, 29.5, 30.23, 3
0.6, 31.33, 31.7, 32, 32, 31.47, 31.1, 30.37, 30]+273);

```

```

energyp10=(enep275+enep276+enep277+enep278+enep279+enep280+enep281+enep282+enep283+enep284+enep285+enep286+enep287+enep288+enep289+enep290+enep291+enep292+enep293+enep294+enep295+enep296+enep298+enep299+enep300+enep301+enep302+enep303+enep304)/29;
totalp10=energyp10*31;
energyp10=[enep275, enep276, enep277, enep278, enep279, enep280, enep281, enep282, enep283, enep284, enep285, enep286, enep287, enep288, enep289, enep290, enep291, enep292, enep293, enep294, enep295, enep296, enep298, enep299, enep300, enep301, enep302, enep303, enep304];
octp=[2, 3, 4, 5, 6, 7, 8, 9, 10, 11, 12, 13, 14, 15, 16, 17, 18, 19, 20, 21, 22, 23, 25, 26, 27, 28, 29, 30, 31];

```

⌘

```

[novp1, enep305] = theoreticalpowerpoly(305, 23.7, [06 04], [17 19], [24, 24.08, 24.78, 25.27, 26.67, 27.18, 27.88, 28, 28, 28.28, 28.98, 29.33, 30.03, 30.38, 31, 31, 30.87, 30.52, 29.82, 29.47]+273);
[novp2, enep306] = theoreticalpowerpoly(306, 23.7, [06 05], [17 19], [24, 24.1, 24.8, 25.15, 25.85, 26.2, 26.9, 27.25, 27.95, 28.3, 29, 29.7, 31, 31, 30.9, 30.55, 30, 30, 26.4, 28.4]+273);
[novp3, enep307] = theoreticalpowerpoly(307, 23.7, [06 05], [17 18], [24, 24.1, 24.8, 25.3, 26.7, 27.2, 27.9, 28, 28, 28.3, 29, 29.35, 30, 30, 29.9, 29.55, 29.85, 29.5, 27.8, 27.45]+273);
[novp4, enep308] = theoreticalpowerpoly(308, 23.7, [06 06], [17 18], [24, 24, 24, 24.17, 24.87, 25.43, 26.83, 27.27, 27.97, 27.32, 29.02, 29.37, 30, 30, 29.88, 29.53, 29, 28.48, 27.78, 27.43]+273);
[novp5, enep309] = theoreticalpowerpoly(309, 23.7, [06 06], [17 17], [24, 24.12, 24.82, 25.17, 25.87, 26.22, 26.92, 27.27, 27.97, 28.32, 28.98, 28.63, 28, 28, 28, 28, 28, 28, 28, 28, 28]+273);
[novp6, enep310] = theoreticalpowerpoly(310, 23.7, [06 07], [17 17], [23, 23.13, 23.83, 24.18, 24.88, 25.23, 25.93, 26, 26, 26.33, 27.03, 27.38, 28, 28, 28.13, 28.48, 29, 29, 28.75, 28.42]+273);
[novp7, enep311] = theoreticalpowerpoly(311, 23.7, [06 08], [17 16], [23, 23.15, 23.85, 24.2, 24.9, 25.25, 25.95, 26, 26, 26.35, 27.05, 27.4, 28.1, 28.45, 29, 29, 29, 29, 29, 29]+273);
[novp8, enep312] = theoreticalpowerpoly(312, 23.7, [06 08], [17 16], [23, 23.15, 23.85, 25.15, 25.85, 26.5, 27.9, 28.5, 30, 30, 30, 30, 30, 30, 30, 30, 30, 29.85, 29.45, 28.75, 28.4]+273);
[novp9, enep313] = theoreticalpowerpoly(313, 23.7, [06 09], [17 15], [20.37, 20.33, 21.73, 22.43, 23.83, 24.53, 25.93, 26.63, 28.03, 28.73, 30, 30, 30, 30.12, 30.47, 30.83, 30.48, 30, 30, 29.47, 28.77]+273);
[novp10, enep314] = theoreticalpowerpoly(314, 23.7, [06 10], [17 15], [23.83, 24, 24, 24.47, 25.87, 26.57, 27.97, 28.33, 29, 29, 29.08, 29.43, 30.13, 30.48, 30.82, 30.47, 29.93, 29.42, 28.72, 28.37]+273);
[novp11, enep315] = theoreticalpowerpoly(315, 23.7, [06 10], [17 14], [22, 22.18, 22.88, 23.23, 24.93, 28.13, 26.93, 27.67, 29.03, 29.38, 30, 30, 30, 30, 30, 30, 29.94, 29.42, 28.73, 28.37]+273);
[novp12, enep316] = theoreticalpowerpoly(316, 23.7, [06 11], [17 14], [21.37, 21.53, 22.25, 22.6, 23.6, 24.3, 25.37, 26.4, 26.47, 27.17, 28.45, 28.8, 29.5, 29.85, 30, 30, 28.8, 28.1, 28.45, 28]+273);

```



```

[novp13, enep317] = theoreticalpowerpoly(317, 23.7, [06 11], [17
14], [20, 20.2, 20.9, 21.75, 23.85, 24.3, 25, 25.7, 27.05, 24.4, 28.1, 28.
45, 29, 29, 29, 29, 28.72, 28.4, 27.7, 27.45]+273);
[novp14, enep318] = theoreticalpowerpoly(318, 23.7, [06 12], [17
13], [18.27, 18.43, 19.83, 21.07, 23.87, 24.63, 26.02, 26.37, 27.13, 27.
83, 29, 29, 29, 29, 29.22, 29.57, 29.7, 29.38, 29, 29]+273);
[novp15, enep319] = theoreticalpowerpoly(319, 23.7, [06 13], [17
13], [20, 20.23, 20.93, 21.85, 23.95, 24.67, 26.07, 26.77, 28.17, 28.87,
30, 30, 30, 30, 30.23, 30.57, 31.32, 31.63, 29.72, 29.32]+273);
[novp16, enep320] = theoreticalpowerpoly(320, 23.7, [06 13], [17
13], [22, 22.47, 23.87, 24.28, 24.98, 25.33, 26.03, 26.38, 27.08, 27.43,
28.13, 28.48, 30, 30, 30.23, 30.58, 30.68, 30.37, 29.43, 28.63]+273);
[novp17, enep321] = theoreticalpowerpoly(321, 23.7, [06 14], [17
12], [20.9, 21.25, 21.95, 22.3, 23, 23.35, 24.02, 24.4, 25.1, 25.45, 26.3
, 27, 28.4, 29.07, 29.5, 28.8, 27.67, 27.45, 26.4, 26.6]+273);
[novp18, enep322] = theoreticalpowerpoly(322, 23.7, [06 15], [17
12], [19.08, 19.53, 20.93, 21.95, 23.02, 23.37, 25.03, 25.42, 26.23, 26.
93, 28.67, 29.03, 30, 30, 30, 30, 29.5, 29.33, 28.68, 28.28]+273);
[novp19, enep323] = theoreticalpowerpoly(323, 23.7, [06 15], [17
12], [19.17, 19.53, 20.93, 21.95, 24.03, 24.73, 26.03, 26.42, 27.23, 27.
93, 29.17, 29.52, 30.22, 30.57, 30.47, 29.77, 29, 29, 28.68, 28.28]+273)
;
[novp20, enep324] = theoreticalpowerpoly(324, 23.7, [06 16], [17
12], [20, 20.28, 20.98, 21.67, 23.07, 23.77, 25.1, 25.87, 27.27, 27.97, 2
9, 29, 29.23, 29.58, 29.43, 28.73, 28, 28, 27.33, 26.53]+273);
[novp21, enep325] = theoreticalpowerpoly(325, 23.7, [06 17], [17
11], [20, 20.6, 22, 22.7, 25.05, 25.4, 26.07, 26.45, 27.15, 27.5, 28, 28, 2
8, 28, 28.3, 28.65, 28.75, 28.3, 28, 28]+273);
[novp22, enep326] = theoreticalpowerpoly(326, 23.7, [06 18], [17
11], [19, 19.95, 22.02, 22.37, 23.07, 23.42, 24.17, 24.93, 26.33, 27.03,
28, 28, 28, 28, 28.32, 28.67, 28.63, 28.28, 27.63, 27.23]+273);
[novp23, enep327] = theoreticalpowerpoly(327, 23.7, [06 18], [17
11], [19.97, 20.32, 21.05, 22.1, 24.13, 24.83, 26.08, 26.47, 27.17, 27.5
2, 28.22, 28.57, 29.27, 29.62, 30, 30, 29.63, 29.28, 28.63, 28.23]+273);
[novp24, enep328] = theoreticalpowerpoly(328, 23.7, [06 19], [17
11], [19, 19.33, 20.1, 21.15, 23.17, 23.87, 25.1, 25.48, 26.18, 26.53, 27
.23, 27.58, 28, 28, 28, 28, 27.662, 27.27, 26.62, 26.22]+273);
[novp25, enep329] = theoreticalpowerpoly(329, 23.7, [06 20], [17
11], [20, 20.18, 21.15, 22.2, 24.2, 24.9, 26.23, 27, 28.2, 28.55, 29.25, 2
9.6, 29.7, 29.45, 29, 29, 28.2, 27.5, 26.2, 25.4]+273);
[novp26, enep330] = theoreticalpowerpoly(330, 23.7, [06 20], [17
11], [20, 20.7, 22.1, 22.8, 24.2, 24.9, 26.23, 27, 28, 28, 28.25, 28.6, 29.
3, 29.65, 29.75, 29.3, 28.6, 28.35, 27.6, 27.2]+273);
[novp27, enep331] = theoreticalpowerpoly(331, 23.7, [06 21], [17
11], [21.02, 21.37, 22.07, 22.42, 23.12, 23.47, 24.27, 25.03, 26.22, 26.
57, 27.27, 27.61, 28.32, 28.67, 28.63, 28.28, 27.17, 26.47, 25.58, 25.18
]+273);
[novp30, enep334] = theoreticalpowerpoly(334, 23.7, [06 23], [17
11], [20.05, 25.4, 21.3, 22.35, 24.15, 24.5, 25.33, 26.1, 27.25, 27.6, 28
.3, 28.65, 29, 29, 29, 29, 28.1, 27.4, 26.55, 26.15]+273);

```

```

energyp11=(enep305+enep306+enep307+enep308+enep309+enep310+enep311+enep312+enep313+enep314+enep315+enep316+enep317+enep318+enep319+enep320+enep321+enep322+enep323+enep324+enep325+enep326+enep327+enep328+enep329+enep330+enep331+enep334)/28;
totalp11=energyp11*30;
energyp11=[enep305,enep306,enep307,enep308,enep309,enep310,enep311,enep312,enep313,enep314,enep315,enep316,enep317,enep318,enep319,enep320,enep321,enep322,enep323,enep324,enep325,enep326,enep327,enep328,enep329,enep330,enep331,enep334];
novp=[1,2,3,4,5,6,7,8,9,10,11,12,13,14,15,16,17,18,19,20,21,22,23,24,25,26,27,30];

```

␣

```

[decpl,enep335] = theoreticalpowerpoly(335,23.7,[06 24],[17 11],[20.07,20.4,21.13,21.8,23.13,23.8,25.07,25.4,26.13,26.8,11.07,11.4,29.07,29.4,30,30,30,29.93,28.87,28.2]+273);
[decp2,enep336] = theoreticalpowerpoly(336,23.7,[06 24],[17 11],[20.07,20.4,21.07,21.4,22.2,23.2,25.07,25.4,26.07,26.4,27.07,27.4,28.07,28.4,29,29,28.93,28.6,27.87,27.2]+273);
[decp3,enep337] = theoreticalpowerpoly(337,23.7,[06 25],[17 11],[20.17,20.83,22.17,22.83,24.08,24.42,25.17,25.83,27.25,28.25,30,30,30,30,29.92,29.58,29,29,28.83,28.17]+273);
[decp4,enep338] = theoreticalpowerpoly(338,23.7,[06 26],[17 11],[20.2,20.87,22.2,22.87,24.2,24.87,26.1,26.43,27.1,27.43,28.1,28.43,29,29,29.1,29.43,29.8,29.13,27.9,27.67]+273);
[decp6,enep340] = theoreticalpowerpoly(340,23.7,[06 27],[17 11],[20.23,20.9,22.12,22.45,23.23,23.9,25.23,25.9,27.12,27.45,28.12,28.45,29,29,29,29,28.77,28.1,27,27]+273);
[decp7,enep341] = theoreticalpowerpoly(341,23.7,[06 28],[17 12],[20.27,20.93,22.13,22.47,23.27,23.93,25.13,25.47,26.13,26.47,27.13,27.47,28,28,27.87,27.63,26.87,26.63,25.87,25.63]+273);
;
[decp8,enep342] = theoreticalpowerpoly(342,23.7,[06 28],[17 12],[20,20,20.23,20.9,22.23,22.9,24.23,24.9,26.13,26.47,27.23,27.9,29,29,29,29,29,28.87,28.63,27.87,27.53]+273);
[decp9,enep343] = theoreticalpowerpoly(343,23.7,[06 29],[17 12],[18.3,18.97,20.3,20.97,24,24,24,24,24.3,24.97,26.15,26.48,27,27,27.15,27.48,28.15,28.48,26.85,26.62]+273);
[decp10,enep344] = theoreticalpowerpoly(344,23.7,[06 30],[17 12],[20.17,20.5,21.33,22,23.33,24,25.17,25.5,26.33,27,28.17,28.5,29,29,28.83,28.5,27.83,27.5,26.83,26.5]+273);
[decp11,enep345] = theoreticalpowerpoly(345,23.7,[06 30],[17 13],[21.17,21.5,22.17,22.5,23.33,24,25.17,25.5,26.17,26.5,27,27,27.17,27.5,28,28,27.83,27.5,26.83,26.5]+273);
[decp12,enep346] = theoreticalpowerpoly(346,23.7,[06 31],[17 13],[18.18,18.52,19.37,20.03,21.37,22.03,23.18,23.52,24.18,24.52,25,25,25.18,25.52,26,26,25.88,25.47,25,25]+273);
[decp13,enep347] = theoreticalpowerpoly(347,23.7,[06 32],[17 13],[16.2,16.53,17.6,18.6,20.2,20.53,23.2,23.53,24.4,25.07,26,26,26.2,26.53,27,27,26.8,26.47,25.6,24.93]+273);

```

```

[decpl4, enep348] = theoreticalpowerpoly(348, 23.7, [06 32], [17
14], [17.8, 17.43, 17.6, 18.6, 20.4, 21.07, 22.4, 23.07, 24.4, 25.07, 26.
2, 26.53, 27, 27, 26.8, 26.47, 25.8, 25.47, 24.8, 24.47]+273);
[decpl5, enep349] = theoreticalpowerpoly(349, 23.7, [06 33], [17
14], [16, 16, 16.65, 17.65, 19.43, 20.1, 21.43, 22.1, 23.43, 24.1, 25.43,
26.1, 27, 27, 26.78, 26.45, 25.78, 25.45, 23.78, 23.45]+273);
[decpl6, enep350] = theoreticalpowerpoly(350, 23.7, [06 33], [17
14], [16.22, 16.55, 17.22, 17.55, 18.87, 20.2, 22.43, 23.1, 24.22, 24.55
, 25.22, 25.55, 26.22, 26.55, 27, 27, 26.88, 26.45, 25.57, 24.9]+273);
[decpl7, enep351] = theoreticalpowerpoly(351, 23.7, [06 34], [17
15], [17.47, 18.13, 19.23, 19.57, 20.23, 20.57, 21.23, 21.57, 22.23, 22.
57, 23.47, 24.13, 25.23, 25.57, 25.77, 25.43, 24.77, 24.43, 25, 25]+273)
;
[decpl8, enep352] = theoreticalpowerpoly(352, 23.7, [06 35], [17
15], [15.25, 15.42, 17, 18.33, 20.5, 21.17, 22.25, 22.58, 23.5, 24.17, 25
, 25, 25.25, 25.58, 25.75, 25.42, 25, 25, 24.75, 24.42]+273);
[decpl9, enep353] = theoreticalpowerpoly(353, 23.7, [06 35], [17
16], [16.25, 16.42, 17.5, 18.17, 19.5, 20.17, 21.25, 21.42, 22.5, 23.17,
24, 24, 24.25, 24.42, 24.75, 24.48, 24.25, 24.42, 24.5, 23.83]+273);
[decpl20, enep354] = theoreticalpowerpoly(354, 23.7, [06 36], [17
16], [15.27, 15.6, 16.53, 17.2, 18.53, 19.2, 20.53, 21.2, 22.53, 23.2, 24
.27, 24.6, 25, 25, 24.73, 24.4, 23.73, 23.4, 23, 23]+273);
[decpl21, enep355] = theoreticalpowerpoly(355, 23.7, [06 36], [17
17], [19, 19, 19, 19, 19, 19, 19.27, 19.6, 20.27, 20.6, 21.53, 22.2, 23, 23,
23.27, 23.6, 24, 24, 23.73, 23.4]+273);
[decpl22, enep356] = theoreticalpowerpoly(356, 23.7, [06 37], [17
17], [18, 18, 18.28, 18.62, 19.28, 19.62, 20.28, 20.62, 21.28, 21.62, 22.
28, 22.62, 23, 23, 23, 23, 22.82, 22.48, 21.82, 21.48]+273);
[decpl23, enep357] = theoreticalpowerpoly(357, 23.7, [06 37], [17
18], [19.28, 19.62, 20, 20, 20.57, 21.23, 22.57, 23.23, 24.28, 24.62, 25,
25, 25.28, 25.62, 26, 26, 25.43, 24.77, 23.82, 23.48]+273);
[decpl24, enep358] = theoreticalpowerpoly(358, 23.7, [06 38], [17
18], [17.7, 17.37, 17.6, 18.27, 19.6, 20.27, 21.6, 22.27, 23.6, 24.27, 25
.6, 26.27, 27, 27, 27, 27, 26.7, 26.67, 25.7, 25.67]+273);
[decpl25, enep359] = theoreticalpowerpoly(359, 23.7, [06 38], [17
18], [17.3, 17.63, 18, 18, 18.3, 18.63, 19.3, 19.63, 20.3, 20.63, 21.6, 22
.27, 23, 23, 23, 23, 22.4, 21.73, 20.7, 20.37]+273);
[decpl26, enep360] = theoreticalpowerpoly(360, 23.7, [06 38], [17
19], [15.3, 15.63, 16, 16, 16.3, 16.63, 17.3, 17.63, 18.6, 19.27, 20.3, 20
.63, 21, 21, 21.3, 21.63, 22, 22, 22, 22]+273);
[decpl27, enep361] = theoreticalpowerpoly(361, 23.7, [06 39], [17
20], [14, 14, 14, 14, 14.32, 14.65, 15.32, 15.65, 16.32, 16.65, 17.32, 17.
65, 18.32, 18.65, 19.32, 19.65, 18.68, 19.45, 19, 19]+273);
[decpl28, enep362] = theoreticalpowerpoly(362, 23.7, [06 39], [17
20], [15, 15, 15.32, 15.65, 16.63, 17.3, 18.32, 18.65, 19.32, 19.65, 20.3
2, 20.65, 21.63, 22.3, 23, 23, 22.78, 22.45, 19.47, 20.7]+273);
[decpl29, enep363] = theoreticalpowerpoly(363, 23.7, [06 40], [17
21], [14.33, 14.67, 15.67, 16.33, 17, 17, 17.33, 17.67, 18.33, 18.67, 19.
67, 20.33, 21.33, 21.67, 22.67, 23.33, 23.77, 23.37, 22.77, 22.37]+273)
;

```

```
[decp30, enep364] = theoreticalpowerpoly(364, 23.7, [06 40], [17
22], [14, 14, 14.67, 15.33, 16.67, 17.33, 18.67, 19.33, 21, 22, 23.33, 23.
67, 24.33, 24.67, 24.77, 24.33, 24, 24, 23.33, 22.67]+273);
[decp31, enep365] = theoreticalpowerpoly(365, 23.7, [06 40], [17
22], [13.67, 14.33, 15, 15, 15.33, 15.67, 16.67, 16.33, 18.33, 18.67, 19.
67, 20.33, 21.33, 21.67, 21.33, 21.33, 21.33, 21.33, 21.77, 21.43]+273)
;
```

```
energyp12=(enep335+enep336+enep337+enep338+enep340+enep341+ene
p342+enep343+enep344+enep345+enep346+enep347+enep348+enep349+e
nep350+enep351+enep352+enep353+enep354+enep355+enep356+enep357
+enep358+enep359+enep360+enep361+enep362+enep363+enep364+enep3
65)/30;
```

```
totalp12=energyp12*31;
```

```
energyp12=[enep335, enep336, enep337, enep338, enep340, enep341, ene
p342, enep343, enep344, enep345, enep346, enep347, enep348, enep349, e
nep350, enep351, enep352, enep353, enep354, enep355, enep356, enep357
, enep358, enep359, enep360, enep361, enep362, enep363, enep364, enep3
65];
```

```
decp=[1, 2, 3, 4, 6, 7, 8, 9, 10, 11, 12, 13, 14, 15, 16, 17, 18, 19, 20, 21, 22, 2
3, 24, 25, 26, 27, 28, 29, 30, 31];
```

```
Month=[1, 2, 3, 4, 5, 6, 7, 8, 9, 10, 11, 12];
```

```
totalpenergyp=[ totalp1,
totalp2, totalp3, totalp4, totalp5, totalp6, totalp7, totalp8, totalp
9, totalp10, totalp11, totalp12];
```

```
%%%Tempdata
```

```
JanTavg=[18.7330, 21.5105, 22.2010, 21.0317, 20.0177, 18.2480, 14.61
90, 12.8613, 13.4453, 21.5417, 23.7500, 22.0033, 22.4273, 18.4820, 18.
6323, 20.4867, 22.4340];
```

```
FebTavg=[21.007, 22.836, 24.515, 24.333, 25.962, 26.00467, 27.3133, 2
6.9933, 28.09867, 28.32633, 27.57767];
```

```
MarTavg=[26.796, 27.6415, 29.21733, 28.7775, 28.78567, 27.71, 28.462
33, 29.238, 31.26, 30.38067, 29.459, 28.758, 30.151, 29.822, 29.52167,
30.697, 32.231, 32.725, 31.96357, 30.49167, 31.78167, 30.5331];
```

```
AprTavg=[31.126, 33.405, 31.883, 31.435, 32.57367, 33.07, 32.46967, 3
1.3933, 33.813, 33.56133, 32.3233, 31.551, 28.33667, 24.74557, 29.352
67, 30.65733, 29.1703, 29.78733, 25.961, 29.695, 30.7271, 32.137, 32.5
1, 29.80633, 29.089, 31.607, 31.651];
```

```
MayTavg=[33.40967, 33.96433, 31.17867, 26.193, 23.75167, 27.36, 30.1
7733, 28.07, 31.50167, 31.973, 28.506, 25.66362, 24.41533, 29.61833, 2
9.77167, 32.10467, 28.62833, 28.63, 26.68967, 25.821, 26.48233, 29.84
433, 30.3133, 30.52633, 40.098, 29.64, 28.617, 26.91133];
```

```
JuneTavg=[30.74552, 31.66448, 33.12828, 31.44172, 31.53276, 30.6496
6, 27.45379, 31.47276, 31.40793, 31.25483, 33.26552, 32.46724, 32.167
93, 29.92793, 31.94483, 32.16828, 32.47724, 33.95414, 30.86241, 30.78
241, 33.65983, 31.25966, 33.01828, 32.09448, 28.82517, 29.68207, 29.5
8172, 28.23172, 27.32207, 29.30034];
```

```

JulyTavg=[30.111,31.143,30.621,29.29,31.472,31.095,31.381,32.1
16,31.391,31.172,31.334,29.893,29.167,30.301,31.136,30.716,31.
187,30.418,30.071,29.974,32.426,30.075,32.830,32.298,31.,29.07
3,28.175,28.033,29.473,30.107,29.076];
AugTavg=[31.778,31.404,31.319,31.761,27.176,29.352,29.685,30.6
27,30.609,28.456,28.481,31.778,29.08,30.778,20.723,31.191,31.0
24,30.11,29.218,31.171,30.488,31.159,31.158,30.489,30.703,26.6
34,27.335,31.315,30.488,32.226];
SepTavg=[30.353,30.923,30.548,29.778,26.656,29.437,29.074,31.0
05,31.33,31.310,31.384,30.717,31.334,30.293,27.313,28.981,28.1
33];
OctTavg=[31.989,29.456,26.894,27.378,27.605,28.302,29.785,29.9
10,30.864,31.57,31.54,29.785,30.766,30.349,28.887,30.486,30.60
5,30.716,28.729,28.077,27.908,26.993,26.638,25.626,26.891,27.9
06,28.642,28.081,28.805];
NovTavg=[28.359,27.97,27.877,27.346,27.181,26.62,26.585,28.096
,27.262,28.064,27.482,26.635,26.065,26.448,27.040,27.405,25.50
0,26.399,26.742,26.144,26.364,27.789,26.694,25.673,26.391,26.6
79,25.514,26.480];
DecTavg=[24.741,25.743,25.743,26.61,26.115,28.443,25.717,24.89
,25.929,25.647,23.563,23.525,23.524,22.852,23.247,22.697,27.71
9,22.087,21.677,21.338,21.099,23.353,33.396,20.49,19.243,16.89
5,19.468,19.542,20.737,21.733];
JanT=sum(JanTavg)/17;
FebT=sum(FebTavg)/11;
MarT=sum(MarTavg)/22;
AprT=sum(AprTavg)/27;
MayT=sum(MayTavg)/28;
JuneT=sum(JuneTavg)/30;
JulyT=sum(JulyTavg)/31;
AugT=sum(AugTavg)/30;
SepT=sum(SepTavg)/17;
OctT=sum(OctTavg)/29;
NovT=sum(NovTavg)/28;
DecT=sum(DecTavg)/30;

Temperature=[JanT, FebT, MarT, AprT, MayT, JuneT, JulyT, AugT, SepT, Oc
tT, NovT, DecT];
Intensity=[549.7279,564.8544,574.6825,591.6366,580.2789,576.37
96,583.8717,591.4996,585.0832,541.3622,530.8690,534.7277];
%%%%%%plotting start

figure()
subplot(331)
hold on
plot(janp,energypl,Jan,Energyl,Jan,JanTavg,'Linewidth',3),titl
e('energy in january'),xlabel('january'), ylabel('energy
/Whr')
hold off

```

```
%figure()
subplot(332)
hold on
plot(febsp,energyp2,Feb,Energy2,Feb,FebTavg,'Linewidth',3),title('energy in february'),xlabel('february'),ylabel('energy/Whr')
hold off
```

```
%figure()
subplot(333)
hold on
plot(marp,energyp3,Mar,Energy3,Mar,MarTavg,'Linewidth',3),title('energy in march'),xlabel('march'),ylabel('energy/Whr')
hold off
```

```
%figure()
subplot(334)
hold on
plot(aprp,energyp4,Apr,Energy4,Apr,AprTavg,'Linewidth',3),title('energy in april'),xlabel('april'),ylabel('energy/Whr')
hold off
```

```
%figure()
subplot(335)
hold on
plot(mayp,energyp5,May,Energy5,May,MayTavg,'Linewidth',3),title('energy in may'),xlabel('may'),ylabel('energy/Whr')
hold off
```

```
%figure()
subplot(336)
hold on
plot(junep,energyp6,June,Energy6,June,JuneTavg,'Linewidth',3),title('energy in june'),xlabel('junep'),ylabel('energy/Whr')
hold off
```

```
%figure()
subplot(337)
hold on
plot(julyp,energyp7,July,Energy7,July,JulyTavg,'Linewidth',3),title('energy in july'),xlabel('july'),ylabel('energy/Whr');
hold off
```

```
%figure()
subplot(338)
hold on
```

```

plot(augp,energyp8,Aug,Energy8,Aug,AugTavg,'Linewidth',3),title('energy in augpust'),xlabel('augpust'),ylabel('energy/Whr')
hold off

%figure()
subplot(339)
hold on
plot(septp,energyp9,Sept,Energy9,Sept,SepTavg,'Linewidth',3),title('energy in september'),xlabel('september'),ylabel('energy/Whr')
hold off

figure()
subplot(131)
hold on
plot(octp,energyp10,Oct,Energy10,Oct,OctTavg,'Linewidth',3),title('energy in october'),xlabel('october'),ylabel('energy/Whr')
hold off

%figure()
subplot(132)
hold on
plot(novp,energyp11,Nov,Energy11,Nov,NovTavg,'Linewidth',3),title('energy in november'),xlabel('november'),ylabel('energy/Whr')
hold off

%figure()
subplot(133)
hold on
plot(decp,energyp12,Dec,Energy12,Dec,DecTavg,'Linewidth',3),title('energyp in december'),xlabel('december'),ylabel('energy/Whr')
hold off

figure()
subplot(311)
hold on
plot(Month, totalenergyp,Month,TotalEnergy,'Linewidth',3),title('energy over the year 2013'),xlabel('Months'),ylabel('energy/Whr')
hold off
subplot(312)

```

```

plot(Month, Temperature, 'Linewidth', 3), xlabel('Months'),
ylabel('Temperature in Centigrade'), title('Variation of
Monthly average temperature over the year 2013 in Dhaka')
subplot(313)
plot(Month, Intensity, 'Linewidth', 3), xlabel('Months'),
ylabel('Solar Illumination in W/m2'), title('Variation of
Monthly average solar illumination over the year 2013 in
Dhaka')

```

Analytical energy comparison with varying R_s :

```

clc;
close all;
clear all;

[jan1, ene1] = expmono(1, 23.7, [6 41], [17
23], [12, 12.03, 12.35, 12.68, 13.35, 13.68, 14.875, 15.708, 17.375, 18.
208, 19.875, 20.083, 22.375, 23.208, 24.35, 24.68, 24.65, 24.32, 22.65,
22.32]+273);
[jan3, ene3] = expmono(3, 23.7, [6 41], [17
24], [16, 16.03, 16.7, 17.37, 18.525, 19.025, 20.025, 20.525, 21.7, 22.3
7, 23.35, 23.68, 24.35, 24.68, 24.825, 24.658, 24.325, 24.158, 23.3, 22.
63]+273);
[jan4, ene4] = expmono(4, 23.7, [6 42], [17
25], [16.35, 16.68, 17.7, 18.37, 19.35, 19.68, 20.7, 21.37, 22.7, 23.37,
24.35, 24.68, 25, 25, 25, 25, 24.65, 24.32, 23.97, 23.65]+273);
[jan5, ene5] = expmono(5, 23.7, [6 42], [17
26], [15.37, 15.7, 16, 16, 16.73, 17.4, 18.73, 19.4, 20.73, 21.4, 22.37, 2
2.7, 23.37, 23.7, 24.37, 24.7, 25, 25, 24.63, 24.3]+273);
[jan6, ene6] = expmono(6, 23.7, [6 42], [17
26], [15.37, 15.7, 16, 16, 16.73, 17.4, 18.73, 19.4, 20.37, 20.7, 21.73, 2
2.4, 23, 23, 23, 23, 22.27, 21.6, 21, 21]+273);
[jan7, ene7] = expmono(7, 23.7, [6 42], [17
27], [14.37, 14.7, 15.37, 15.7, 16, 16, 16.73, 17.4, 18.73, 19.4, 20, 20, 2
0, 20, 20, 20, 20, 19.63, 19.3]+273);
[jan8, ene8] = expmono(8, 23.7, [6 42], [17
28], [10, 10.03, 10.37, 10.7, 11.37, 11.7, 13.1, 14.1, 15.37, 15.7, 16.37
, 16.7, 17, 17, 17, 17, 17, 17, 16.97, 15.97]+273);
[jan9, ene9] = expmono(9, 23.7, [6 42], [17
29], [8.27, 7.93, 8.1, 9.1, 10.73, 11.4, 12.37, 12.7, 13, 13, 13.37, 13.7,
14.37, 14.7, 15.37, 15.7, 16, 16, 14.63, 14.3]+273);
[jan10, ene10] = expmono(10, 23.7, [6 43], [17
29], [7.38, 7.72, 8.38, 8.72, 9.38, 9.72, 10.77, 11.43, 12.77, 13.43, 14.
77, 15.43, 16.38, 16.72, 17.38, 17.72, 17.63, 17.28, 16.62, 16.28]+273)
;
[jan15, ene15] = expmono(15, 23.7, [6 43], [17
33], [13.38, 13.72, 14.77, 15.43, 17.15, 18.15, 19.7, 20.43, 21.77, 22.4
3, 25, 25, 25, 25, 25.38, 25.72, 25.62, 25.28, 24.62, 24.28]+273);

```



```

[jan18,ene18] = expmono(18,23.7,[6 43],[17
35],[14.38,14.72,15.92,18.58,20.77,21.43,22.38,22.72,23.77,24.
43,25.77,26.43,27.38,27.72,28.38,28.72,28.23,27.57,26.23,25.57
]+273);
[jan20,ene20] = expmono(20,23.7,[6 42],[17
36],[17,17,17.38,17.72,18.77,19.43,20.38,20.72,21.38,21.72,22.
38,22.72,23.77,24.43,25.38,25.72,26,26,25.23,24.57]+273);
[jan23,ene23] = expmono(23,23.7,[6 42],[17
39],[15.63,15.3,15.73,16.4,17.73,18.4,19.73,20.4,21.73,22.4,23
.73,24.4,26.1,27.1,28,28,27.27,26.6,25.63,25.3]+273);
[jan25,ene25] = expmono(25,23.7,[6 41],[17
40],[12,12,12.4,12.74,14.2,15.2,16.4,16.73,17.4,17.73,19.2,20.
2,21.8,22.47,23,23,23,22.93,22.27,21.93]+273);
[jan27,ene27] = expmono(27,23.7,[6 41],[17
41],[12,12,12.4,12.75,14.35,15.4,16.5,16.85,17.55,17.9,19.8,20
.85,22.3,23,23,23,23,22.9,22.2,21.85]+273);
[jan29,ene29] = expmono(29,23.7,[6 40],[17
43],[12.65,12.3,12.4,12.75,14.8,16.2,18.5,19.55,21.1,21.8,23.2
,23.9,24.65,25,25,25,25,24.9,24.2,23.85]+273);
[jan31,ene31] = expmono(31,23.7,[6 40],[17
44],[15.35,15.7,16.4,16.75,17.45,17.8,19,19.7,21.65,22.7,24.8,
25.85,26.65,27,27.7,27.95,27.35,26.8,25.4,23.85]+273);

```

```

energy1=
(ene1+ene3+ene4+ene5+ene6+ene7+ene8+ene9+ene10+ene15+ene18+ene
20+ene23+ene25+ene27+ene29+ene31)/17;
total1=energy1*31;
Energy1=[ene1,ene3,ene4,ene5,ene6,ene7,ene8,ene9,ene10,ene15,e
ne18,ene20,ene23,ene25,ene27,ene29,ene31];
Jan=[1,3,4,5,6,7,8,9,10,15,18,20,23,25,27,29,31];
%figure()
%plot(Jan,Energy1,'Linewidth',3),title('Energy in
January'),xlabel('January'),ylabel('Energy /Whr')

%

```

```

[feb1,ene32] = expmono(32,23.7,[6 39],[17
45],[15.32,15.67,16.73,17.43,18.83,19.53,20.93,21.63,22,22,23.
13,23.83,23.38,23.03,23,22.98,22.28,22,22,22]+273);
[feb2,ene33] = expmono(33,23.7,[6 39],[17
46],[15.32,15.67,16.73,17.43,18.83,19.53,20.93,21.63,23.03,23.
73,25.13,26.08,26.62,26.97,27,26.98,26.28,25.93,25.23,24.88]+2
73);
[feb4,ene35] = expmono(35,23.7,[6 38],[17
47],[17.3,17.65,18.7,19.4,20.8,21.5,22.9,23.6,25.5,26.55,27.55
,27.9,28,28,28,28,27.3,26.95,26.25,25.9,]+273);
[feb9,ene40] = expmono(40,23.7,[6 35],[17
50],[18.25,18.6,19.3,19.65,21.05,22.1,23.4,23.75,24.45,24.8,26
.1,26.7,27,27,27.6,27.95,27.45,27,26.3,25.95]+273);

```

```

[feb13,ene44] = expmono(44,23.7,[6 33],[17
53],[19,19,19.53,20.23,21.63,22.33,23.73,24.43,25.83,26.53,28.
03,28.63,29.52,29.87,30,30,30,30,29.33,28.98]+273);
[feb21,ene52] = expmono(52,23.7,[6 27],[17
57],[19,19,19.43,20.17,21.63,22.37,23.83,24.57,26.03,26.77,28.
23,28.97,29.72,30,30,30,30,29.72,28.97,28.23]+273);
[feb22,ene53] = expmono(53,23.7,[6 26],[17
58],[21.2,21.6,22.1,22.6,23.5,24.6,25.4,25.8,26.5,26.8,27.4,27
.9,28.7,29.5,31.8,31.6,31.2,30.8,30,29.6]+273);
[feb23,ene54] = expmono(54,23.7,[6 26],[17
58],[19,19,19.4,20.5,21.5,22.3,24.2,25.3,27,27.73,29.2,29.93,3
1.4,32.13,32,32,32,31.8,31,29.9]+273);
[feb25,ene56] = expmono(56,23.7,[6 24],[17
59],[21.1,21.4,22.54,23.8,25.45,26.69,27.2,27.84,28.64,28.89,2
9,29,29.64,30.1,30.79,31.4,31.93,31.5,30.07,29.33]+273);
[feb27,ene58] = expmono(58,23.7,[6 22],[18
00],[20,20,20.8,23,26.23,26.6,27.33,28.4,29.43,29.8,30.53,30.9
,31.63,32,32.73,32.53,31.6,30.87,29.7,29.33]+273);
[feb28,ene59] = expmono(59,23.7,[6 21],[18
01],[20,20,20.35,21.45,23.65,24.35,25.3,25.79,26.35,27.65,29.0
3,29.77,31.23,31.97,32.72,32.92,32.18,31.82,31.08,30.72]+273);

energy2=(ene32+ene33+ene35+ene40+ene44+ene52+ene53+ene54+ene56
+ene58+ene59)/11;
total2= energy2*28;
Energy2=[ene32,ene33,ene35,ene40,ene44,ene52,ene53,ene54,ene56
,ene58,ene59];
Feb =[1,2,4,9,13,21,22,23,25,27,28];
%figure()
%plot(Feb,Energy2,'Linewidth',3),title('Energy in
February'),xlabel('February'), ylabel('Energy/Whr')

%

[mar1,ene60] = expmono(60,23.7,[6 21],[18
01],[20.03,20.38,21.23,21.97,23.43,24.17,25.63,26.37,25.83,26.
57,27.52,27.88,29.62,29.98,30.72,31,31,30.82,30.02,29.43]+273)
;
[mar3,ene62] = expmono(62,23.7,[6 19],[18
02],[18.99,19.65,21.33,22.73,24.18,24.55,25.65,26.75,27.72,28.
63,29.67,30.78,31.665,31.97,32,31.91,31.13,30.98,30.63,29.5]+2
73);
[mar5,ene64] = expmono(64,23.7,[6 17],[18
03],[21,21.32,22.15,23.25,25.45,26.55,28.5,29.23,30.35,30.72,3
1.45,31.82,32.55,32.92,33,32.98,32.35,32,32,31.57]+273);
[mar7,ene66] = expmono(66,23.7,[6 15],[18
04],[22,22.85,25.05,25.38,26.12,26.48,27.22,27.58,28.32,28.68,
29.83,30.57,32.03,32.77,32.42,32.12,32.28,31.98,31.12,28.63]+2
73);

```

```

[mar9,ene68] = expmono(68,23.7,[6 13],[18
05],[20,20,20,22.1,26.5,26.9,28.37,29.1,30.28,30.65,31.38,31.7
5,32.48,32.85,33,33,31.28,32,31.53,30.87]+273);
[mar11,ene70] = expmono(70,23.7,[6 11],[18
06],[24,24,24,24.35,25,25,25,25,25.35,25.88,27.05,28.5,29.33,2
9.69,31.34,32.98,32,32,31.35,31]+273);
[mar12,ene71] = expmono(71,23.7,[6 10],[18
06],[24.8,25.35,25.99,26,26.23,26.57,27.28,27.67,28.43,28.82,2
9.58,29.97,31.47,32.23,30.23,30,29.97,29.58,29,29]+273);
[mar13,ene72] = expmono(72,23.7,[6 09],[18
07],[24.88,25.31,25.98,26.23,27.13,28.35,30,30,31.65,31.88,32,
32,31.65,31,31,30.75,29.97,29.2,27.83,27.45]+273);
[mar15,ene74] = expmono(74,23.7,[6 08],[18
07],[25.2,25.37,26.9,26.67,29.1,29.48,30.25,30.63,31.4,31.78,3
2.55,32.93,33.7,34,34,34,34,34,33.7,32.93]+273);
[mar16,ene75] = expmono(75,23.7,[6 07],[18
08],[25.22,25.17,25.93,26.32,27.08,27.93,29.23,29.62,30.38,30.
77,31.53,31.92,32,32.2,34.5,34.88,34.12,34.27,32,32]+273);
[mar17,ene76] = expmono(76,23.7,[6 06],[18
08],[25,25.15,25.92,26.3,27.07,27.9,29.22,29.6,30.37,30.75,31,
31,32.33,33,33,32.8,32.03,30.95,28.65,27.5]+273);
[mar18,ene77] = expmono(77,23.7,[6 05],[18
09],[21.35,21.27,22.8,23.57,25.1,25.43,26.4,27.17,28.7,29.47,3
1,31.77,32.65,33,33,33,33,32.33,30.9,30.52]+273);
[mar20,ene79] = expmono(79,23.7,[6 03],[18
09],[24.28,24,24,24.5,26.02,26.4,27.17,27.55,28.95,30.1,31.93,
32.7,34.23,35,35,34.85,34.02,34,33.8,32.65]+273);
[mar22,ene81] = expmono(81,23.7,[6 01],[18
10],[25,25.06,25.83,26.22,26.98,27.37,28.17,29.03,30.57,31.33,
32,32,32.58,32.97,33,33,33,32.2,29.93,29.17]+273);
[mar23,ene82] = expmono(82,23.7,[6 00],[18
11],[24.67,25,25,25.4,26.93,27.9,29,29,27.8,28.95,32,32,32.57,
32.95,32.37,32.9,32.14,31.75,29.99,29.6]+273);
[mar24,ene83] = expmono(83,23.7,[05 59],[18
11],[25,25.02,25.76,26.35,28.3,29.22,29.95,30.32,31.05,31.42,3
2,32,32.5,32.62,33.35,33.72,34,33.98,33.02,32.43]+273);
[mar25,ene84] = expmono(84,23.7,[05 58],[18
11],[25,25.03,26.6,27.8,28.87,29.8,31.08,31.47,32.47,33.23,34.
3,34.77,35.53,35.92,36,35.93,35.17,34.78,34.02,34]+273);
[mar26,ene85] = expmono(85,23.7,[05 57],[18
12],[26.65,27,27.76,28.13,28.95,29.9,32.2,32.45,33.43,34.2,35,
35,35,35,35.67,36.05,36.82,35.8,34.04,33.3]+273);
[mar27,ene86] = expmono(86,23.7,[05 56],[18
12],[27,27,27.75,28.13,28.9,29.57,31.1,31.887,33.4,33.58,34.35
,34.73,35,34.73,34.27,34,34,33.82,33.04,32]+273);
[mar29,ene88] = expmono(88,23.7,[05 54],[18
13],[25,25,25,25.2,26.73,27.25,28.03,28.8,30,30,30.95,32.1,33.
93,34.7,35.62,36,34.47,34.98,32.17,32]+273);
[mar30,ene89] = expmono(89,23.7,[05 53],[18
13],[26.55,26.93,27.7,28.25,30.55,31.23,32,32,32,32,32,32,3
2,33.8,34.95,35,34.87,34.1,33.72]+273);

```

```

[mar31,ene90] = expmono(90,23.7,[05 52],[18
14],[26,26,26.68,27,27,27.22,27.98,28.73,30.133,30.52,31.28,31
.67,32,32,33.75,34.9,35,35,33.23,32.57]+273);

energy3=(ene60+ene62+ene64+ene66+ene68+ene70+ene71+ene72+ene74
+ene75+ene76+ene77+ene79+ene81+ene82+ene83+ene84+ene85+ene86+e
ne88+ene89+ene90)/22;
total3=energy3*31;
Energy3=[ene60,ene62,ene64,ene66,ene68,ene70,ene71,ene72,ene74
,ene75,ene76,ene77,ene79,ene81,ene82,ene83,ene84,ene85,ene86,e
ne88,ene89,ene90];
Mar=[1,3,5,7,9,11,12,13,15,16,17,18,20,22,23,24,25,26,27,29,30
,31];
%figure()
%plot(Mar,Energy3,'Linewidth',3),title('Energy in
March'),xlabel('March'),ylabel('Energy/Whr')

%

[apr3,ene93] = expmono(93,23.7,[05 49],[18
15],[25,24.72,24.42,24.25,26.65,27.85,30.25,30.48,31.28,32.37,
33.48,33.88,34.68,35.08,35.88,35.72,34.83,34.03,32.72,32.42]+2
73);
[apr4,ene94] = expmono(94,23.7,[05 48],[18
15],[26,26,26.65,27.15,28.55,30.5,32.1,32.9,34.25,34.65,35.25,
35.65,36,36.1,37.9,38,37.95,37.65,36.5,35.7]+273);
[apr5,ene95] = expmono(95,23.7,[05 47],[18
16],[26,26,27.9,29,29,29.23,30.07,30.87,32.47,33.67,34.43,34.8
3,35,35,35,34.77,33.97,33.57,32.77,32.37]+273);
[apr6,ene96] = expmono(96,23.7,[05 46],[18
16],[25.23,25.87,27.27,28.07,28.83,29.23,30.03,30.43,31.23,32.
27,33.43,33.83,34.63,35.03,35.83,36.03,34.97,34.47,33.53,32.73
]+273);
[apr7,ene97] = expmono(97,23.7,[05 45],[18
16],[27,27,28.23,28.03,29.63,30.43,32.03,32.42,33.22,33.62,34,
34,34,34.03,35.63,36,35.97,35.27,34.43,33.77]+273);
[apr9,ene99] = expmono(99,23.7,[05 43],[18
17],[27,27,27.58,27.98,29.57,30.37,31.97,32.38,33.37,34.17,35.
38,35.78,36.58,36.98,36.22,36,36,35.62,34.82,34.42]+273);
[apr10,ene100] = expmono(100,23.7,[05 42],[18
18],[27.37,27.77,28.57,28.97,29,29.17,29.97,30.37,31.33,32.13,
33,33,34.13,34.93,36.13,37,37,36.63,35.83,35.43]+273);
[apr11,ene101] = expmono(101,23.7,[05 41],[18
18],[27,27,27.55,27.95,28.75,29.15,29.95,30.35,31.15,31.55,32.
7,33.5,34.15,34.95,35,34.7,33.1,33,32.85,32.45]+273);
[apr12,ene102] = expmono(102,23.7,[05 40],[18
18],[27.33,27.73,29.07,29.87,30.73,31.13,32.87,33.67,35.27,35.
53,36.33,36.73,37,37,37,36.87,36.03,35.77,34.73,33.93]+273);
[apr13,ene103] = expmono(103,23.7,[05 39],[18
19],[26,26,28.07,29.67,30.72,31.12,31.92,32.32,33.12,33.73,35.
63,36.43,37,37,37,37,37,36.68,35.88,35.48]+273);

```

```

[apr14,ene104] = expmono(104,23.7,[05 38],[18
19],[27.6,28.4,29.5,29.9,30.7,31.1,32.8,33.6,35.2,35.5,35.7,35
.3,34.5,34.1,31.9,30.7,31.9,32,32,32]+273);
[apr15,ene105] = expmono(105,23.7,[05 37],[18
20],[26.28,26.68,27.48,27.88,29.37,30,30,30.28,31.08,31.28,32.
57,33.37,34.28,34.68,35,34.92,34.22,33.82,32.98,32.52]+273);
[apr16,ene106] = expmono(106,23.7,[05 37],[18
20],[24,24,24.48,24.88,25.68,26.08,27.77,28.28,29.08,29.48,30,
30,30,30,30.68,30.92,30.22,30,29.92,29.62]+273);
[apr17,ene107] = expmono(107,23.7,[05 36],[18
21],[23,23,21.13,19.53,19.67,20.07,21.73,22.5,24.13,25.4,27.8,
29,29.53,29.12,29.67,30,30,29.83,28.93,28.53]+273);
[apr18,ene108] = expmono(108,23.7,[05 35],[18
21],[25.25,25.65,26,26,26.65,27.05,27.85,28.23,29.05,29.45,30.
05,30.65,31.45,31.85,33,32.85,32.15,31.85,29.9,30.1]+273);
[apr19,ene109] = expmono(109,23.7,[05 34],[18
21],[25.23,25.63,26,26,27.27,28.07,28.83,29.43,31.07,31.43,32.
23,32.63,33,33,33.63,34,34,33.87,32.97,32.67]+273);
[apr20,ene110] = expmono(110,23.7,[05 33],[18
22],[22.23,22.62,23.83,24.63,26.85,28,28,28.2,29.02,29.42,30.2
2,30.62,31,31,32.23,33,33,32.88,31.98,31.88]+273);
[apr21,ene111] = expmono(111,23.7,[05 32],[18
22],[26,26,26.8,27.6,28.62,29,29.8,30,30,30.4,31.03,31.6,32,32
,32,31.97,30.4,30,30,29.6]+273);
[apr22,ene112] = expmono(112,23.7,[05 31],[18
23],[23.18,23.6,24,24,24.6,24.98,24.32,24.17,24.98,25.38,26.18
,26.58,27,27,27.58,28,28,28,28,28]+273);
[apr23,ene113] = expmono(113,23.7,[05 31],[18
23],[23.37,24.17,25.77,26.57,27.6,27.98,28.78,29.17,29.98,30.7
7,32,32,32,32,31.42,31,32.57,32.73,31.03,30.62]+273);
[apr24,ene114] = expmono(114,23.7,[05 30],[18
23],[24,24,24.73,25.53,27.17,27.93,29.53,30.3,31.93,32.73,33.8
3,33.43,33.73,34.53,34.43,34.02,33.34,32.83,32.04,32]+273);
[apr25,ene115] = expmono(115,23.7,[05 29],[18
24],[27,27,27.7,28.5,29.57,29.95,31.5,32.27,32.95,33.35,34.15,
34.55,35,35,33.9,33.02,33.75,34.15,34.95,32.75]+273);
[apr26,ene116] = expmono(116,23.7,[05 28],[18
24],[27.6,28.07,29.17,29.73,30,30,30.73,32.12,31.93,32.33,33.1
3,33.53,34,34,34.53,34.93,35.73,36.13,35.24,33.8]+273);
[apr27,ene117] = expmono(117,23.7,[05 27],[18
25],[27.12,27.52,28.32,28.72,29.53,29.92,31,31,31,31,31,31,29.
73,28.13,28.03,28.87,30.43,31,31,30.68]+273);
[apr28,ene118] = expmono(118,23.7,[05 27],[18
25],[25.12,25.52,26,26,26.52,26.92,27.52,27.92,28,28.32,29.12,
29.52,30.63,31.43,32.52,32.92,32.38,31.88,31.08,30.78]+273);
[apr29,ene119] = expmono(119,23.7,[05 26],[18
26],[26,26,26.12,26.7,28.03,28.8,29.7,30.08,30.9,31.6,33.1,33.
5,34.13,34.7,35,35,35.7,35.9,35.1,34.1]+273);
[apr30,ene120] = expmono(120,23.7,[05 25],[18
26],[26,26.48,27.28,27.68,28.5,28.88,29.68,30.13,31.77,32.28,3
3.1,33.48,34.28,34.68,35,35,34.42,34,34,33.82]+273);

```

```

energy4=
(ene93+ene94+ene95+ene96+ene97+ene99+ene100+ene101+ene102+ene1
03+ene104+ene105+ene106+ene107+ene108+ene109+ene110+ene111+ene
112+ene113+ene114+ene115+ene116+ene117+ene118+ene119+ene120)/2
2;
total4=energy4*30;
Energy4=[ene93,ene94,ene95,ene96,ene97,ene99,ene100,ene101,ene
102,ene103,ene104,ene105,ene106,ene107,ene108,ene109,ene110,en
e111,ene112,ene113,ene114,ene115,ene116,ene117,ene118,ene119,e
ne120];
Apr=[3,4,5,6,7,9,10,11,12,13,14,15,16,17,18,19,20,21,22,23,24,
25,26,27,28,29,30];
%figure()
%plot(Apr,Energy4,'Linewidth',3),title('Energy in
April'),xlabel('April'), ylabel('Energy/Whr')

%

[may1,ene121] = expmono(121,23.7,[05 25],[18
27],[29,29,29.28,29.68,30,30,30.68,31.1,32.77,33.27,35,35,35,3
5,35.97,36.98,36.62,35.9,35.62,34.82]+273);
[may2,ene122] = expmono(122,23.7,[05 24],[18
27],[29,29,29.26,29.67,30.97,31.73,32.68,33,33,33.27,34.13,34.
93,36,36,36,36,36,35.94,35.13,34.73]+273);
[may3,ene123] = expmono(123,23.7,[05 23],[18
28],[30,30,30.25,30.65,31.47,31.85,32.65,33.07,34.7,35.25,36,3
6,36,36,36,36,35.95,35.25,34.85]+273);
[may4,ene124] = expmono(124,23.7,[05 22],[18
28],[29,29,29,29,29.9,30.67,31.63,32.02,32.83,33.23,34.98,33.5
7,33,33,32.13,31.3,30.47,30,30,29.64]+273);
[may5,ene125] = expmono(125,23.7,[05 22],[18
29],[21.03,21.43,21.77,21.47,21.45,21.83,23.9,25.02,25.83,25.7
,29,29,29.23,29.63,30,30,30,29.94,28.33,27.77]+273);
[may6,ene126] = expmono(126,23.7,[05 21],[18
29],[25,25,25,25,24.57,24.18,22.77,22,21.17,21.23,22,22,22.43,
23.23,24.42,24.83,25,25,25,25]+273);
[may7,ene127] = expmono(127,23.7,[05 21],[18
29],[23,23,23.65,24.85,27.3,28.45,29,29,29.83,29.77,29,29,28.4
5,28.15,26.42,26.83,27.62,28,28,27.57]+273);
[may8,ene128] = expmono(128,23.7,[05 20],[18
30],[27,27.23,28.2,28.6,29.42,29.8,30.6,30.98,31.82,32.22,33,3
3,33,33,32.6,32.18,30,27,27,27.2]+273);
[may9,ene129] = expmono(129,23.7,[05 19],[18
30],[24.98,25.38,26.37,27.17,28,28,28,28,27.2,27,27,27.8,29,29
,29,29,29.58,29.98,30,29.63]+273);
[may10,ene130] = expmono(130,23.7,[05 19],[18
31],[26.98,27.38,28.18,28.58,29.23,29.78,30.58,30.98,31.8,32,3
2,32.4,33.18,33.32,34.38,34.8,34.42,33.02,32.22,32.82]+273);

```

```

[may11,ene131] = expmono(131,23.7,[05 18],[18
31],[29,28.63,28.5,29.7,31.38,31.77,32,32,32,32.18,32.97,33.38
,34.17,34.6,34.63,34.22,32.3,31.1,31.77,31.83]+273);
[may12,ene132] = expmono(132,23.7,[05 18],[18
32],[28,27.63,27,27,27.38,27.77,28.57,28.95,29.57,30.27,27.13,
27,27.17,27.6,28.73,29.57,30,30,30,30]+273);
[may16,ene136] = expmono(136,23.7,[05 16],[18
34],[25,25,25,25,25,25,24.47,24.08,24,24,24,24,24,24,24,24,
24,24,24.73,25]+273);
[may17,ene137] = expmono(137,23.7,[05 15],[18
34],[24.98,25.32,26.12,26.52,27.33,27.72,28.52,28.9,29,29.13,2
9.92,30.33,31.12,31.72,32,32,32,32,30.28,31]+273);
[may18,ene138] = expmono(138,23.7,[05 15],[18
35],[26,26.32,27.12,27.52,28.67,29.43,30,30,31.13,32,32,32.33,
33,33,31.73,30.07,28.48,28.02,28.72,28.88]+273);
[may19,ene139] = expmono(139,23.7,[05 15],[18
35],[26,26.63,28.12,28.52,29.67,30.43,31.52,31.9,32.57,33,33,3
3.33,34,34,34.32,34.73,35,35,34.33,33.77]+273);
[may20,ene140] = expmono(140,23.7,[05 14],[18
36],[28.98,29,29.1,29.5,30.32,30.7,31.5,31.88,32,31.77,30.2,28
.73,26,26,26,26,26,26,26.7,27]+273);
[may21,ene141] = expmono(141,23.7,[05 14],[18
36],[27,27,27.2,27.63,28,28,28.8,29,29,29,29,29,29,29.13,30,30
,29.7,29.27,28.4,28]+273);
[may22,ene142] = expmono(142,23.7,[05 13],[18
37],[24.22,24.32,25.18,25.62,26,26,26,26.28,27,27,27.38,27.82,
27.32,27,27,27,27.68,27.72,28,28]+273);
[may23,ene143] = expmono(143,23.7,[05 13],[18
37],[27,26.1,24,24,24.48,24.97,25,25,25,25,25,26,25,25.12,25.9
8,26.83,28,28,28,28]+273);
[may24,ene144] = expmono(144,23.7,[05 13],[18
38],[24,24,24,24,24.48,24.92,25,25.57,27.17,28.03,29,29,29,29,
29,28.17,26.72,26.28,26,25.98]+273);
[may25,ene145] = expmono(145,23.7,[05 13],[18
38],[27,27,27.18,27.62,28.48,28.92,29,29.23,30,30,30.77,31.63,
32,32,32,32,31.72,31.28,30.42,29.98]+273);
[may26,ene146] = expmono(146,23.7,[05 12],[18
39],[27,27,27.17,27.6,28.47,28.9,29.77,30.22,31.07,31.5,32.36,
32.8,33,33,33,33,33,33,33,33]+273);
[may27,ene147] = expmono(147,23.7,[05 12],[18
39],[28,28.3,29.17,29.6,30.93,31.8,32.77,33,33,33,33,33,29.65,
29.05,29.93,29.4,29.73,28.65,28.57,29]+273);
[may28,ene148] = expmono(148,23.7,[05 12],[18
40],[27,27,27.17,27.6,28.47,28.9,29.77,30.22,31,31,31.37,31.8,
32.67,32.9,32.03,31.6,30.73,30.3,30,30]+273);
[may29,ene149] = expmono(149,23.7,[05 12],[18
40],[28,28,28,28,28,28,28.77,29.43,31,31,31,31,31,30.9,30.03,3
0,30,30,30,30]+273);
[may30,ene150] = expmono(150,23.7,[05 11],[18
40],[26.85,27.28,28.3,29.17,30.45,30.88,29.5,29,29.05,29.48,29
.65,29.22,29,28.95,28.05,28,27.75,27.42,27,27]+273);

```

```

[may31,ene151] = expmono(151,23.7,[05 11],[18
41],[27,27,27,27,27.45,27.88,28.75,28.8,27.95,27.52,27,27,27.8
2,28,28,27.23,25.5,24.63,24,24]+273);

energy5=(ene121+ene122+ene123+ene124+ene125+ene126+ene127+ene1
28+ene129+ene130+ene131+ene132+ene136+ene137+ene138+ene139+ene
140+ene141+ene142+ene143+ene144+ene145+ene146+ene147+ene148+en
e149+ene150+ene151)/28;
total5=energy5*31;
Energy5=[ene121,ene122,ene123,ene124,ene125,ene126,ene127,ene1
28,ene129,ene130,ene131,ene132,ene136,ene137,ene138,ene139,ene
140,ene141,ene142,ene143,ene144,ene145,ene146,ene147,ene148,en
e149,ene150,ene151];
May=[1,2,3,4,5,6,7,8,9,10,11,12,16,17,18,19,20,21,22,23,24,25,
26,27,28,29,30,31];
%figure()
%plot(May,Energy5,'Linewidth',3),title('Energy in
May'),xlabel('May'), ylabel('Energy/Whr')

%

[june1,ene152] = expmono(152,23.7,[05 11],[18
41],[25,25.57,27.15,27.58,28.9,29.77,30.75,31.18,32.05,32.48,3
3,33,33,33,33,32.62,31.75,31.32,31,31]+273);
[june2,ene153] = expmono(153,23.7,[05 11],[18
42],[28,28,28.15,28.59,29.45,29.89,31.5,32,32.05,32.48,33,33,3
3,33.08,33.95,34.38,34.5,33.63,31.9,31.03]+273);
[june3,ene154] = expmono(154,23.7,[05 11],[18
42],[28.13,28.65,29.15,29.59,30.9,31.77,32.75,33,33.05,33.49,3
4.35,34.79,35,35.09,35.95,36,35.75,35.31,34.45,34.01]+273);
[june4,ene155] = expmono(155,23.7,[05 11],[18
43],[28.15,28.29,29.3,30.17,31,31,31,31.19,32,32,32.35,32.79,3
3.65,34,34,33.61,32,30.26,30.1,30.97]+273);
[june5,ene156] = expmono(156,23.7,[05 11],[18
43],[29.43,29.65,30.15,30.59,31,31,31.75,32.19,33,33,33,33,33,
32.83,31.1,31,31,31,31,31]+273);
[june6,ene157] = expmono(157,23.7,[05 11],[18
43],[27,27.57,29.15,29.59,30.45,30.89,31.75,32,31.95,31.51,31,
31,31.65,32,32,31.23,30,30,30.55,30.99]+273);
[june7,ene158] = expmono(158,23.7,[05 11],[18
44],[27,27,27,27,27.45,27.89,27.25,27,27,27,27,27,27.65,28,28,
28,28,28,28,28]+273);
[june8,ene159] = expmono(159,23.7,[05 11],[18
44],[27.43,27.65,28.15,28.59,29.9,30.77,31.75,32,32.05,32.49,3
3.35,33.79,34,34,34,33.23,31.75,31.31,31,31]+273);
[june9,ene160] = expmono(160,23.7,[05 11],[18
45],[28,28.29,29.15,29.59,30.45,30.89,31.75,32,31.95,31.51,31,
31,31.65,32.17,33.9,34,33.5,32.63,32,32]+273);

```



```

[june10,ene161] = expmono(161,23.7,[05 11],[18
45],[28.85,29,29.15,29.59,30,30,30.75,31.19,32,32,32.35,32.79,
33,32.95,32.52,32.3,31.87,31.65,31.22,31]+273);
[june11,ene162] = expmono(162,23.7,[05 11],[18
45],[29,29.43,30.73,31.38,32.45,32.89,33.75,34,34.05,34.49,35,
35,35,35,34.61,33.75,33.31,32.45,32.01]+273);
[june12,ene163] = expmono(163,23.7,[05 11],[18
46],[29.15,29,29,29,29.9,30.77,31.75,32.19,33.05,33.49,34,34,3
4,34.09,34.95,34.61,34,34,34,34]+273);
[june13,ene164] = expmono(164,23.7,[05 11],[18
46],[29,29,29,29,29.45,29.89,31.5,32.19,33.05,33.49,34,34,34.6
5,34.91,34.05,33.61,33,33,33,33]+273);
[june14,ene165] = expmono(165,23.7,[05 11],[18
46],[28.15,28.29,29.15,29.59,30,30,30.75,31,31.05,31.49,30.6,2
8.86,28.65,29,29,29.39,30.25,30.69,31,31]+273);
[june15,ene166] = expmono(166,23.7,[05 11],[18
47],[28,28.29,29.15,29.59,30.45,30.89,31,31.19,32.05,32.49,33,
33,33.65,34.09,34.95,34.23,33,33,33,33]+273);
[june16,ene167] = expmono(167,23.7,[05 11],[18
47],[29,29.29,30.15,30.59,31.45,31.89,32,32,32,32,32,32,32.65,
33.09,33.95,34,34,34,33.45,33.01]+273);
[june17,ene168] = expmono(168,23.7,[05 11],[18
47],[30.15,30.29,31,31,31.27,31.53,32.05,32.31,32.83,33.09,33.
61,33.87,33.35,33,33,33.39,33.75,33.31,33,33]+273);
[june18,ene169] = expmono(169,23.7,[05 12],[18
47],[31,31,31.15,31.59,32.45,32.89,33.5,33.79,34.37,34.66,35,3
5,35.65,36,36,36,35.5,34.63,34,34]+273);
[june19,ene170] = expmono(170,23.7,[05 12],[18
48],[30,30.29,31,31,31,31,31,31,31,31,31,31,31.65,32,32,31.61,
30,30,29.45,29.01]+273);
[june20,ene171] = expmono(171,23.7,[05 12],[18
48],[27,29.29,28.3,29.17,30,30,30.75,31.19,32,32,32.35,32.79,3
1.7,30.91,30.05,30.39,31.25,31.69,31.45,31.01]+273);
[june21,ene172] = expmono(172,23.7,[05 12],[18
48],[29,29.29,30.15,30.59,31.45,31.89,32.75,33.19,34.05,34.49,
35.35,35.79,36,36,36,36,35.75,35.31,34.45,34.01]+273);
[june22,ene173] = expmono(173,23.7,[05 12],[18
48],[27,27,27,27,28.8,30.54,31,31,31.08,31.73,33.03,33.68,34,3
4,34,33.61,32.75,32.31,32,32]+273);
[june23,ene174] = expmono(174,23.7,[05 13],[18
49],[29,29,29.15,29.59,30.9,31.77,32.75,33.19,34,34,34.35,34.7
9,35,35,35,35,34.75,34.31,34,34]+273);
[june24,ene175] = expmono(175,23.7,[05 13],[18
49],[28,28.29,29,29,29.45,29.89,32.25,33,33,33,33,33,33,33.09,
33.95,34.39,34.75,34.31,33.45,33.01]+273);
[june25,ene176] = expmono(176,23.7,[05 13],[18
49],[27,27.29,28.08,28.3,28.73,28.95,29,29,29,29,29,29,29.0
9,29.95,29.61,29,29,29,29]+273);
[june26,ene177] = expmono(177,23.7,[05 13],[18
49],[27.85,28,28.15,28.59,29.9,29.77,31,30.81,30.1,30.97,32,32
,30.05,29,29,29,29,29,29,29]+273);

```

```
[june27,ene178] = expmono(178,23.7,[05 14],[18
49],[28,28,28,28,28.9,28.77,39,30.37,31.8,30.07,28,28,29.3,29.
91,29.05,29.38,30,30,30,30]+273);
[june28,ene179] = expmono(179,23.7,[05 14],[18
49],[28,28.28,29,29,29.9,29.77,29.75,29,28.95,28.52,28,28,28,2
7.97,27.05,27,27,27,27,27]+273);
[june29,ene180] = expmono(180,23.7,[05 14],[18
49],[26.15,26,27.15,27.59,27,27,27.75,28,28,28,27.65,27.21,27,
27,27,27.77,28.5,27.63,27,27]+273);
[june30,ene181] = expmono(181,23.7,[05 15],[18
49],[27.85,28,28,28,28,28,28.75,29.18,30,30,30,30,30,30,30,30,
30,30,30,30]+273);
```

```
energy6=(ene152+ene153+ene154+ene155+ene156+ene157+ene158+ene1
59+ene160+ene161+ene162+ene163+ene164+ene165+ene166+ene167+ene
168+ene169+ene170+ene171+ene172+ene173+ene174+ene175+ene176+en
e177+ene178+ene179+ene180+ene181)/30;
```

```
total6=energy6*30;
```

```
Energy6=[ene152,ene153,ene154,ene155,ene156,ene157,ene158,ene1
59,ene160,ene161,ene162,ene163,ene164,ene165,ene166,ene167,ene
168,ene169,ene170,ene171,ene172,ene173,ene174,ene175,ene176,ene
177,ene178,ene179,ene180,ene181];
```

```
June=[1,2,3,4,5,6,7,8,9,10,11,12,13,14,15,16,17,18,19,20,21,22
,23,24,25,26,27,28,29,30];
```

```
%figure()
```

```
%plot(June,Energy6,'Linewidth',3),title('Energy in
June'),xlabel('June'), ylabel('Energy/Whr')
```

```
%
```

```
[july1,ene182] = expmono(182,23.7,[05 15],[18
49],[27,27.43,28,28,28.86,29,29,29.43,30.72,31.58,31.58,30,30.
86,30,30.86,31.43,31.98,32,31.43,31]+273);
```

```
[july2,ene183] = expmono(183,23.7,[05 15],[18
49],[28,28,28,28,28.86,29,30.72,31.15,32.33,32.76,33,33,31.83,
29.57,31.86,32.72,34,33.95,32.66,31.8]+273);
```

```
[july3,ene184] = expmono(184,23.7,[05 16],[18
49],[28,28.43,29,29,29.86,30,30.28,30.42,30.7,30.84,31.41,31.8
4,31.96,31.57,31.04,31.47,31.93,31.96,31.04,31]+273);
```

```
[july4,ene185] = expmono(185,23.7,[05 16],[18
49],[28,28.43,29.29,29.58,30.87,31.73,29.99,28.69,29.55,29.65,
29.85,29.95,29.23,28.66,28.57,28.14,28.49,28.92,28.92,29]+273)
```

```
;
```

```
[july5,ene186] = expmono(186,23.7,[05 16],[18
49],[27.86,28.07,28.7,28.91,29.55,29.98,30.84,31.27,32.13,32.0
6,32.86,33.72,33.832,33.888,34,33.584,32.758,32.345,31.502,31.
089]+273);
```

```
[july6,ene187] = expmono(187,23.7,[05 17],[18
49],[27.96,28.39,29.25,29.68,31.4,31.86,31,31.43,32.29,32.72,3
2.72,32.29,31.9,31.93,32.02,31.77,31.2,31.1,30.6,29.96]+273);
```

```

[july7,ene188] = expmono(188,23.7,[05 17],[18
49],[28,28,28,28,29.72,30.58,32.3,32.73,32.73,31.87,31.87,32.7
3,33,33,33,33,32.57,32.14,32,31.57]+273);
[july8,ene189] = expmono(189,23.7,[05 17],[18
49],[28,28.21,28.63,28.84,29.91,30.77,31.63,32.06,32.92,32.94,
33.39,33.82,34,34,34,34,34,34,33.14,32.71]+273);
[july9,ene190] = expmono(190,23.7,[05 18],[18
49],[29,29.43,30,30,28.28,28,30.6,31,31,31,31.86,32.29,33.15,3
3,33,33,33,33,33]+273);
[july10,ene191] = expmono(191,23.7,[05 18],[18
49],[29,29.43,30,30,30,30,30.86,31.29,32.15,32,32,32,32.86,32.
43,32,32,31.57,31.14,31,31]+273);
[july11,ene192] = expmono(192,23.7,[05 19],[18
49],[28,28,28.43,28.86,30.58,31.44,31,31.86,33,33,33,33,33,33,
32.57,32.14,31.57,31.14,31,31]+273);
[july12,ene193] = expmono(193,23.7,[05 19],[18
49],[27,27,27,27,27.86,28.29,28,28.43,29.15,29.58,30.87,31.73,
32,32.43,33.29,32.86,32,31.57,30.74,30.28]+273);
[july13,ene194] = expmono(194,23.7,[05 20],[18
48],[27,27.43,27.86,27.43,27,27.43,28,28.86,29.29,28.86,29.29,
31.01,30.15,30,30,30,30,30.43,31,31]+273);
[july14,ene195] = expmono(195,23.7,[05 20],[18
48],[28,28,28.43,28.86,28,28,28.86,29.29,30.58,31.44,32.73,33.
16,33,33,32.9,31.6,30,30,30,30]+273);
[july15,ene196] = expmono(196,23.7,[05 20],[18
48],[29,29,29,29,29.86,30,30,30.43,31.29,31.72,32.58,33.01,33.
87,33.44,31.72,32,32,32,31.14,31]+273);
[july16,ene197] = expmono(197,23.7,[05 21],[18
48],[28,28,28.43,28.86,29,29,29.86,30,30.43,30.86,31.72,32,32.
86,33,32.96,32.53,32,32,31.14,31]+273);
[july17,ene198] = expmono(198,23.7,[05 21],[18
48],[29,28.57,28.14,29,29.43,30,30,30.43,30.86,31.72,32.15,33.
01,33,33,33,33,33,32.43,31.57,31]+273);
[july18,ene199] = expmono(199,23.7,[05 22],[18
47],[28,28.56,27,27,27,27,28.72,29.58,31.3,30.87,31.43,31.86,3
2.43,32.86,33,33,32.86,32.43,31.14,31]+273);
[july19,ene200] = expmono(200,23.7,[05 22],[18
47],[28,28.43,28.43,28,28.43,28,28.86,29.29,30.15,30,30.43,30.
86,31.72,32,32,31.5,31,31,31,31]+273);
[july20,ene201] = expmono(201,23.7,[05 23],[18
47],[28,28,28.43,28.86,29,29.43,30,30,30,30,31.72,32,33.72,32.
42,30.26,29.4,29,29,29.86,30]+273);
[july21,ene202] = expmono(202,23.7,[05 23],[18
46],[29,29,29.43,29.86,30.72,31.15,32.01,32.44,33.3,33.73,34,3
4,34.86,35,34.57,34.14,33.28,32.85,31.99,32]+273);
[july22,ene203] = expmono(203,23.7,[05 23],[18
46],[28,28.43,28.43,28,28.43,28,28.86,29.29,30.15,30,30.43,30.
86,31.72,32,32,31.5,31,31,31,31]+273);
[july23,ene204] = expmono(204,23.7,[05 24],[18
46],[29,29.43,30,30,31.72,32.15,33.01,33,33.43,33.865,34,34,34
,34,34,34,34,34,33.57]+273);

```

```

[july24,ene205] = expmono(205,23.7,[05 24],[18
45],[29,29.43,30.29,30.72,30.96,31.06,31,31,31.43,31.86,32.72,
33.15,33,33.86,35,35,34.57,34.14,33.28,33]+273);
[july25,ene206] = expmono(206,23.7,[05 25],[18
45],[29,28.57,28.57,29,29.86,30,30,30.43,31.29,31.72,32.58,33.
01,33,33,33,33,32.86,32.43,31.14,31]+273);
[july26,ene207] = expmono(207,23.7,[05 25],[18
45],[28,28,28.43,28.86,28.33,28,28,28.43,29,29,29,29,29,29,29.
86,30.29,31.15,30.72,29.86,29.43]+273);
[july27,ene208] = expmono(208,23.7,[05 26],[18
44],[27,27,27,27,28.72,29,29.86,29.43,28.57,28.14,28.14,28.14,
28.14,28.14,28.14,28.14,28.14,28.14,28.14]+273);
[july28,ene209] = expmono(209,23.7,[05 26],[18
43],[27,27.43,28,28,28,27.14,27,27,27,27,27,28.72,29,29.86,
29.43,29,29,28.57,28.14]+273);
[july29,ene210] = expmono(210,23.7,[05 27],[18
43],[27,27,27.43,27.86,27.86,27.43,28,28,28.43,28.86,29.72,30.
15,31.01,31,31.86,31.43,31,31.43,31.43,31]+273);
[july30,ene211] = expmono(211,23.7,[05 27],[18
42],[28,28,28,28,28.86,29.32,29,29.86,31.58,31,31.43,31.86,32,
32,32,31.44,29.42,30,30,30]+273);
[july31,ene212] = expmono(212,23.7,[05 27],[18
42],[28,28,28.43,28.86,28.33,28,28,28.43,29,29,29,29,29,29,29.
86,30.29,31.15,30.72,29.86,29.43]+273);

```

```

energy7=(ene182+ene183+ene184+ene185+ene186+ene187+ene188+ene1
89+ene190+ene191+ene192+ene193+ene194+ene195+ene196+ene197+ene
198+ene199+ene200+ene201+ene202+ene203+ene204+ene205+ene206+en
e207+ene208+ene209+ene210+ene211+ene212)/31;

```

```

total7=energy7*31;

```

```

Energy7=[ene182,ene183,ene184,ene185,ene186,ene187,ene188,ene1
89,ene190,ene191,ene192,ene193,ene194,ene195,ene196,ene197,ene
198,ene199,ene200,ene201,ene202,ene203,ene204,ene205,ene206,en
e207,ene208,ene209,ene210,ene211,ene212];

```

```

July=[1,2,3,4,5,6,7,8,9,10,11,12,13,14,15,16,17,18,19,20,21,22
,23,24,25,26,27,28,29,30,31];

```

```

%figure()

```

```

%plot(July,Energy7,'Linewidth',3),title('Energy in
July'),xlabel('July'), ylabel('Energy/Whr');

```

```

%

```

```

[aug2,ene214] = expmono(214,23.7,[05 28],[18
41],[29,29,29,29,30.04,30.09,30.99,32,32.43,32.86,32.26,33.69,
32.83,33.05,33.91,33.79,33.43,33,32.57,32.14]+273);

```

```

[aug3,ene215] = expmono(215,23.7,[05 29],[18
40],[29.05,29.61,30,30,30,30.06,30.97,31,31.15,31.56,32,32,32,
32.06,32.9,33,32.86,32.45,32,32]+273);

```

```

[aug4,ene216] = expmono(216,23.7,[05 29],[18
40],[29,29,29.4,29.81,30.63,31,31,31,31,31,31.4,30.81,32,32,32
,31.7,31.13,31.55,32,32]+273);
[aug5,ene217] = expmono(217,23.7,[05 30],[18
39],[29,29,29,29,30.29,31.26,31.9,32.31,33,33,33.4,33.81,34,34
,34,33.4,32,32,31.4,30.57]+273);
[aug6,ene218] = expmono(218,23.7,[05 30],[18
38],[27,27,27,27,27,27,27,27,27.15,27.56,27.6,27.18,27,27,27,2
7,27,27,27.3,27.71]+273);
[aug7,ene219] = expmono(219,23.7,[05 31],[18
37],[27.18,27.58,28.41,28.83,30,30,30,30.33,30.16,30.58,31,31,
31,30.83,29.16,28.85,28,28,28,28]+273);
[aug8,ene220] = expmono(220,23.7,[05 31],[18
37],[28,28,28,28,28.65,29,29,29.33,30,30,30.41,30.83,31,30.83,
29.16,29.63,31,31,30.68,30.26]+273);
[aug9,ene221] = expmono(221,23.7,[05 31],[18
36],[28,28,28.41,28.83,29,29.09,29.99,30.33,31,31,31,31,31.66,
32,32,32,32,32,32,32]+273);
[aug10,ene222] = expmono(222,23.7,[05 32],[18
35],[28,28,28.41,28.83,29,29.09,29.99,30.33,31,31,30.81,32,32,
32,31.7,31.28,31.55,31.96,32,31.73]+273);
[aug11,ene223] = expmono(223,23.7,[05 32],[18
35],[27,27,27,27,26.31,26.11,26.91,27.73,29,29,29.45,29.86,30.
7,30.88,30.05,30,30,30,30,30]+273);
[aug12,ene224] = expmono(224,23.7,[05 33],[18
34],[27.21,27.61,28,28,28.67,29.11,29.91,30,29.77,29.53,29.45,
29.86,30.7,30.88,30.05,30,30,30,30,30]+273);
[aug13,ene225] = expmono(225,23.7,[05 33],[18
33],[29,29,29,29,30.04,30.09,30.99,32,32.43,32.86,32.26,33.69,
32.83,33.05,33.91,33.79,33.43,33,32.57,32.14]+273);
[aug14,ene226] = expmono(226,23.7,[05 33],[18
32],[27,27,27,27,27.34,28.09,28.94,29,29,29,29.37,29.91,30.61,
30.94,30.07,30,30,30,30,30]+273);
[aug15,ene227] = expmono(227,23.7,[05 34],[18
32],[29,29,29,29,30.04,30.09,30.99,32,32.43,32.86,32.26,33.69,
32.83,33.05,33.91,33.79,33.43,33,32.57,32.14]+273);
[aug16,ene228] = expmono(228,23.7,[05 34],[18
32],[26,26.31,27,27,27,27,27,27,27.41,27.64,28.29,28.91,29,29.
67,30.91,31,31,31,31,31]+273);
[aug17,ene229] = expmono(229,23.7,[05 35],[18
30],[28,28,28,28,28.29,28.91,29.45,29.86,31.2,32.45,32.26,33.6
9,32.83,33.05,33.91,33.79,33.43,33,32.57,32.14]+273);
[aug18,ene230] = expmono(230,23.7,[05 35],[18
29],[29,29,29,29,30.04,30.09,30.99,32,32.43,32.86,32,32,32,32,
32,32,31.77,31.35,30.77,30.65]+273);
[aug19,ene231] = expmono(231,23.7,[05 35],[18
28],[29,29,29,29,30.04,30.09,30.99,30,30,30,30,30,30,30,30.94,
31,31,31,30.5,30.32]+273);
[aug20,ene232] = expmono(232,23.7,[05 36],[18
27],[27,27.43,27.86,27.43,27,27.43,28,28.86,29.29,28.86,29.29,
31.01,30.15,30,30,30,30,30.43,31,31]+273);

```

```

[aug21,ene233] = expmono(233,23.7,[05 36],[18
27],[28,28,28.43,28.86,30.58,31.44,31,31.86,33,33,31.86,31.43,
31.43,31.86,32.72,33.15,32.29,31.86,31,31]+273);
[aug22,ene234] = expmono(234,23.7,[05 37],[18
26],[28,28.21,28.63,28.84,29.91,30.77,31.63,32.06,32.92,31.57,
31,31,31,30.77,30.27,30,30,30.43,31,31]+273);
[aug23,ene235] = expmono(235,23.7,[05 37],[18
25],[29,29.43,30,30,30,30,30.86,31.29,32.15,32,32,32,32.86,32.
43,32,32,31.57,31.14,31,31]+273);
[aug24,ene236] = expmono(236,23.7,[05 37],[18
24],[29,29.43,30,30,30,30,30.86,31.29,32.15,32,32,32,32.86,32.
43,32,32,31.57,31.14,31,31]+273);
[aug25,ene237] = expmono(237,23.7,[05 38],[18
23],[28,28.21,28.63,28.84,29.91,30.77,31.63,32.06,32.92,31.57,
31,31,31,30.77,30.27,30,30,30.43,31,31]+273);
[aug26,ene238] = expmono(238,23.7,[05 38],[18
22],[28.43,28.86,29.86,30.72,31.47,32.33,33,33,33.43,31.57,31,
31,31,30.77,30.27,30,30,30.43,29.31,29]+273);
[aug27,ene239] = expmono(239,23.7,[05 38],[18
21],[26,26.55,27.63,27.88,27.21,26,26,26,27,27.31,27.81,27.43,
27,27,26.34,26,26,26,26,26]+273);
[aug28,ene240] = expmono(240,23.7,[05 39],[18
20],[26,26.55,26,26,26,26.88,27.68,28,28,28.6,28.84,28.63,27.6
3,27.07,26.43,27,27,27.77,27.91,28]+273);
[aug29,ene241] = expmono(241,23.7,[05 39],[18
19],[28,28,28.43,28.86,30.58,31.44,31,31.86,33,33,33,33,33,33,
32.57,32.14,31.57,31.14,31,31]+273);
[aug30,ene242] = expmono(242,23.7,[05 39],[18
18],[28,28.21,28.63,28.84,29.91,30.77,31.63,32.06,32.92,31.57,
31,31,31,30.77,30.27,30,30,30.43,31,31]+273);
[aug31,ene243] = expmono(243,23.7,[05 40],[18
17],[29,29,29.43,29.86,30.72,31.15,32.01,32.44,33.3,33.73,34,3
4,34.86,35,34.57,34.14,33.28,31.77,31.14,31]+273);

```

```

energy8=(ene214+ene215+ene216+ene217+ene218+ene219+ene220+ene2
21+ene222+ene223+ene224+ene225+ene226+ene227+ene228+ene229+ene
230+ene231+ene232+ene233+ene234+ene235+ene236+ene237+ene238+en
e239+ene240+ene241+ene242+ene243)/30;

```

```

total8=energy8*31;

```

```

Energy8=[ene214,ene215,ene216,ene217,ene218,ene219,ene220,ene2
21,ene222,ene223,ene224,ene225,ene226,ene227,ene228,ene229,ene
230,ene231,ene232,ene233,ene234,ene235,ene236,ene237,ene238,en
e239,ene240,ene241,ene242,ene243];

```

```

Aug=[2,3,4,5,6,7,8,9,10,11,12,13,14,15,16,17,18,19,20,21,22,23
,24,25,26,27,28,29,30,31];

```

```

%figure()

```

```

%plot(Aug,Energy8,'Linewidth',3),title('Energy in
August'),xlabel('August'),ylabel('Energy/Whr')

```

%

```
[sept3,ene246] = expmono(246,23.7,[05 41],[18  
14],[28,28,29.17,29.95,30,30.08,30.9,31.17,32,32,32,32,32,32,2  
8.87,29.17,30,30,30,30]+273);  
[sept4,ene247] = expmono(247,23.7,[05 41],[18  
13],[27,27,27.35,27.88,28,28.1,28.93,29.77,31.27,31.6,32.3,32.  
67,33.69,33.96,34,33.91,32.87,32.51,32,32]+273);  
[sept5,ene248] = expmono(248,23.7,[05 41],[18  
12],[27,28.13,28.07,27.37,27,27.37,28.93,29.43,32,32,32,32,32,  
32,32.77,33,33,32.51,31.77,31.4]+273);  
[sept9,ene252] = expmono(252,23.7,[05 43],[18  
08],[27.21,28.2,29.43,29.86,30.72,31.15,31.91,32,31.66,30.77,2  
9,29,30.88,31.92,29.56,29,28.87,28.41,28,28]+273);  
[sept10,ene253] = expmono(253,23.7,[05 43],[18  
07],[26,26.55,27.63,27.88,27.21,26,26,26,27,27.31,27.81,27.43,  
27,27,26.34,26,26,26,26,26]+273);  
[sept11,ene254] = expmono(254,23.7,[05 43],[18  
06],[27,27,27.35,27.88,28,28.1,28.93,29.77,31.27,31.6,32.3,32.  
67,31.92,30.88,29.68,29.27,28.41,28.06,28.55,28.93]+273);  
[sept14,ene257] = expmono(257,23.7,[05 44],[18  
03],[28,28,28.43,28.86,28.33,28,28,28.43,29,29,29,29,29,29,29.  
86,30.29,31.15,30.72,29.86,29.43]+273);  
[sept15,ene258] = expmono(258,23.7,[05 45],[18  
02],[27.35,27.67,30,30,30.67,31,31,31.23,32,32,32.17,32.58,32.  
87,32.25,29.86,30.29,31,31,31.06,31]+273);  
[sept16,ene259] = expmono(259,23.7,[05 45],[18  
01],[28,28,28,28,28.68,29.17,30.62,31.23,32.01,32.24,33.1,33.3  
4,32.87,31.98,32.45,32.81,33,33,33,33]+273);  
[sept19,ene262] = expmono(262,23.7,[05 46],[17  
58],[27,27.43,28.43,28.86,29.58,30.01,31.73,32,32.43,32.86,32.  
86,32.43,32.1,32.45,32.11,31.6,32.61,33,33,33]+273);  
[sept20,ene263] = expmono(263,23.7,[05 46],[17  
57],[29.05,29.61,30,30,30,30.06,30.97,31,31.15,31.56,32,32,32,  
32.06,32.9,33,32.86,32.45,32,32]+273);  
[sept23,ene266] = expmono(266,23.7,[05 47],[17  
54],[28,28,28.43,28.86,29,29,29.86,30,30.43,30.86,31.72,32,32.  
86,33,32.96,32.53,32,32,31.14,31]+273);  
[sept24,ene267] = expmono(267,23.7,[05 48],[17  
53],[28,28,28.43,28.86,30.58,31.44,31,31.86,33,33,33,33,33,33,  
32.57,32.14,31.57,31.14,31,31]+273);  
[sept25,ene268] = expmono(268,23.7,[05 48],[17  
52],[27,27.43,28,28,28.86,29,29,29.43,30.72,31.58,32,32,31.77,  
31.57,31.04,31.47,31.93,31.96,31.2,30.77]+273);  
[sept28,ene271] = expmono(271,23.7,[05 49],[17  
50],[26.55,26.06,26,26,26.88,27.1,28,28,28.6,28.94,28.63,27.88  
,27.07,26.55,27,27,27.77,27.88,28,28]+273);  
[sept29,ene272] = expmono(272,23.7,[05 49],[17  
48],[27.65,28.88,29,29,29,29,29,29,29,29,29,29,29,29,29,29.33,29.  
95,30,29.87,28.23,27.88]+273);
```



```

[oct12,ene285] = expmono(285,23.7,[05 54],[17
35],[27.57,27.93,28.67,29.03,29.77,30.13,30.87,31.23,31.97,32.
33,33,33,33,33,33.27,32.63,33.63,33.27,32.53,32.17]+273);
[oct13,ene286] = expmono(286,23.7,[05 55],[17
34],[27.58,27.95,28,28,28,28,28.25,28.98,29.35,30.08,30.45,
31.18,31.55,32,32,32,32,31.03,30.3]+273);
[oct14,ene287] = expmono(287,23.7,[05 55],[17
33],[27.58,27.95,28,28.1,29.57,30.15,30.88,31,31,31.35,32,32,3
2,32,32,32,32,31.52,31.15]+273);
[oct15,ene288] = expmono(288,23.7,[05 56],[17
32],[26.6,26.97,28.4,29.07,29.8,30.17,30.9,31.27,32,32.37,32.9
,32.53,32,32,31.7,31.33,30.6,30.23,28.5,27.4]+273);
[oct16,ene289] = expmono(289,23.7,[05 56],[17
32],[26,26,26.7,27.07,27.8,28.17,28.9,29.27,30,30,30,30,30,30,
30,30,30,30,29,28.27]+273);
[oct17,ene290] = expmono(290,23.7,[05 56],[17
31],[26.6,26.97,27.7,28.07,28.8,29.17,29.9,30.27,31,31,31.1,31
.47,32,32,31.7,31.33,30.6,30.23,30,30]+273);
[oct18,ene291] = expmono(291,23.7,[05 57],[17
30],[27,27,27.72,28.08,28.82,29.37,30.83,31.28,32,32,32,32,32,
32,32,32,31.58,31.22,31,31]+273);
[oct19,ene292] = expmono(292,23.7,[05 57],[17
29],[26.62,26.98,27.72,28.17,29.63,30,30,30.28,31,31,31.12,31.
48,32,32,32.32,32.68,33,33,31.97,31.23]+273);
[oct20,ene293] = expmono(293,23.7,[05 58],[17
28],[26,26,26.9,27.1,27.83,28.2,28.93,29.3,30.03,30.4,30.73,29
,29.23,29.6,29.67,29.3,29,29,29,29]+273);
[oct21,ene294] = expmono(294,23.7,[05 58],[17
27],[26,26,26,26.2,27.67,28.2,28.93,29,29,29,29,29,29,29,29,29
,28.57,28.2,27.47,27.1]+273);
[oct22,ene295] = expmono(295,23.7,[05 59],[17
27],[26.65,27,27,27.12,27.85,28.22,28.95,29,29,29,29.15,29.52,
30,30,29,27.85,26.55,26.18,25.45,25.08]+273);
[oct23,ene296] = expmono(296,23.7,[05 59],[17
26],[25,25.02,25.75,26,26,26.22,26.95,27,27.05,27.42,28,28,28,
28,28,28,27.55,27.18,27,27]+273);
[oct25,ene298] = expmono(298,23.7,[06 00],[17
24],[26.33,26.03,26.77,27,27,27,27,27,27,27,27,27,27,27,26.65,
26.27,26,26,26,26]+273);
[oct26,ene299] = expmono(299,23.7,[06 01],[17
24],[24.68,25,25,25.15,25.88,26,26,26,26,26,26,26,26,26,26,
25.52,25.15,25,25]+273);
[oct27,ene300] = expmono(300,23.7,[06 01],[17
23],[25,25,25,25,25,25.25,25.98,26.7,27.83,27.55,27,27,27,27,2
7.73,28.5,29,29,28.42,28.05]+273);
[oct28,ene301] = expmono(301,23.7,[06 02],[17
22],[24.3,24.07,24.8,25.17,25.9,26.27,27,27.37,28,28,28.2,28.5
7,29.6,30.33,31,31,30.5,30.13,26.4,29.03]+273);
[oct29,ene302] = expmono(302,23.7,[06 02],[17
21],[24.3,24.07,24.8,25.33,26.8,27.27,28,28.37,29.1,29.47,30.2
,30.57,31,31,31,31,30.5,30.13,29.4,29.03]+273);

```

```

[oct30,ene303] = expmono(303,23.7,[06 03],[17
21],[24,24.08,24.82,25.18,25.92,26.28,27.02,27.38,28.17,28.97,
30,30,30.32,30.68,30.6,30.22,29.48,29.12,29,29]+273);
[oct31,ene304] = expmono(304,23.7,[06 04],[17
20],[23.23,24,24,24.4,25.87,26.6,28.03,28.4,29.13,29.5,30.23,3
0.6,31.33,31.7,32,32,31.47,31.1,30.37,30]+273);

energy10=(ene275+ene276+ene277+ene278+ene279+ene280+ene281+ene
282+ene283+ene284+ene285+ene286+ene287+ene288+ene289+ene290+en
e291+ene292+ene293+ene294+ene295+ene296+ene298+ene299+ene300+e
ne301+ene302+ene303+ene304)/29;
total10=energy10*31;
Energy10=[ene275,ene276,ene277,ene278,ene279,ene280,ene281,ene
282,ene283,ene284,ene285,ene286,ene287,ene288,ene289,ene290,en
e291,ene292,ene293,ene294,ene295,ene296,ene298,ene299,ene300,e
ne301,ene302,ene303,ene304];
Oct=[2,3,4,5,6,7,8,9,10,11,12,13,14,15,16,17,18,19,20,21,22,23
,25,26,27,28,29,30,31];
%figure()
%plot(Oct,Energy10,'Linewidth',3),title('Energy in
October'),xlabel('October'), ylabel('Energy/Whr')

%

[nov1,ene305] = expmono(305,23.7,[06 04],[17
19],[24,24.08,24.78,25.27,26.67,27.18,27.88,28,28,28.28,28.98,
29.33,30.03,30.38,31,31,30.87,30.52,29.82,29.47]+273);
[nov2,ene306] = expmono(306,23.7,[06 05],[17
19],[24,24.1,24.8,25.15,25.85,26.2,26.9,27.25,27.95,28.3,29,29
.7,31,31,30.9,30.55,30,30,26.4,28.4]+273);
[nov3,ene307] = expmono(307,23.7,[06 05],[17
18],[24,24.1,24.8,25.3,26.7,27.2,27.9,28,28,28.3,29,29.35,30,3
0,29.9,29.55,29.85,29.5,27.8,27.45]+273);
[nov4,ene308] = expmono(308,23.7,[06 06],[17
18],[24,24,24,24.17,24.87,25.43,26.83,27.27,27.97,27.32,29.02,
29.37,30,30,29.88,29.53,29,28.48,27.78,27.43]+273);
[nov5,ene309] = expmono(309,23.7,[06 06],[17
17],[24,24.12,24.82,25.17,25.87,26.22,26.92,27.27,27.97,28.32,
28.98,28.63,28,28,28,28,28,28,28]+273);
[nov6,ene310] = expmono(310,23.7,[06 07],[17
17],[23,23.13,23.83,24.18,24.88,25.23,25.93,26,26,26.33,27.03,
27.38,28,28,28.13,28.48,29,29,28.75,28.42]+273);
[nov7,ene311] = expmono(311,23.7,[06 08],[17
16],[23,23.15,23.85,24.2,24.9,25.25,25.95,26,26,26.35,27.05,24
.4,28.1,28.45,29,29,29,29,29,29]+273);
[nov8,ene312] = expmono(312,23.7,[06 08],[17
16],[23,23.15,23.85,25.15,25.85,26.5,27.9,28.5,30,30,30,30,30,
30,30,30,29.85,29.45,28.75,28.4]+273);
[nov9,ene313] = expmono(313,23.7,[06 09],[17
15],[20.37,20.33,21.73,22.43,23.83,24.53,25.93,26.63,28.03,28.
73,30,30,30.12,30.47,30.83,30.48,30,30,29.47,28.77]+273);

```

```

[nov10,ene314] = expmono(314,23.7,[06 10],[17
15],[23.83,24,24,24.47,25.87,26.57,27.97,28.33,29,29,29.08,29.
43,30.13,30.48,30.82,30.47,29.93,29.42,28.72,28.37]+273);
[nov11,ene315] = expmono(315,23.7,[06 10],[17
14],[22,22.18,22.88,23.23,24.93,28.13,26.93,27.67,29.03,29.38,
30,30,30,30,30,30,29.94,29.42,28.73,28.37]+273);
[nov12,ene316] = expmono(316,23.7,[06 11],[17
14],[21.37,21.53,22.25,22.6,23.6,24.3,25.37,26.4,26.47,27.17,2
8.45,28.8,29.5,29.85,30,30,28.8,28.1,28.45,28]+273);
[nov13,ene317] = expmono(317,23.7,[06 11],[17
14],[20,20.2,20.9,21.75,23.85,24.3,25,25.7,27.05,24.4,28.1,28.
45,29,29,29,29,28.72,28.4,27.7,27.45]+273);
[nov14,ene318] = expmono(318,23.7,[06 12],[17
13],[18.27,18.43,19.83,21.07,23.87,24.63,26.02,26.37,27.13,27.
83,29,29,29,29,29.22,29.57,29.7,29.38,29,29]+273);
[nov15,ene319] = expmono(319,23.7,[06 13],[17
13],[20,20.23,20.93,21.85,23.95,24.67,26.07,26.77,28.17,28.87,
30,30,30,30,30.23,30.57,31.32,31.63,29.72,29.32]+273);
[nov16,ene320] = expmono(320,23.7,[06 13],[17
13],[22,22.47,23.87,24.28,24.98,25.33,26.03,26.38,27.08,27.43,
28.13,28.48,30,30,30.23,30.58,30.68,30.37,29.43,28.63]+273);
[nov17,ene321] = expmono(321,23.7,[06 14],[17
12],[20.9,21.25,21.95,22.3,23,23.35,24.02,24.4,25.1,25.45,26.3
,27,28.4,29.07,29.5,28.8,27.67,27.45,26.4,26.6]+273);
[nov18,ene322] = expmono(322,23.7,[06 15],[17
12],[19.08,19.53,20.93,21.95,23.02,23.37,25.03,25.42,26.23,26.
93,28.67,29.03,30,30,30,30,29.5,29.33,28.68,28.28]+273);
[nov19,ene323] = expmono(323,23.7,[06 15],[17
12],[19.17,19.53,20.93,21.95,24.03,24.73,26.03,26.42,27.23,27.
93,29.17,29.52,30.22,30.57,30.47,29.77,29,29,28.68,28.28]+273)
;
[nov20,ene324] = expmono(324,23.7,[06 16],[17
12],[20,20.28,20.98,21.67,23.07,23.77,25.1,25.87,27.27,27.97,2
9,29,29.23,29.58,29.43,28.73,28,28,27.33,26.53]+273);
[nov21,ene325] = expmono(325,23.7,[06 17],[17
11],[20,20.6,22,22.7,25.05,25.4,26.07,26.45,27.15,27.5,28,28,2
8,28,28.3,28.65,28.75,28.3,28,28]+273);
[nov22,ene326] = expmono(326,23.7,[06 18],[17
11],[19,19.95,22.02,22.37,23.07,23.42,24.17,24.93,26.33,27.03,
28,28,28,28,28.32,28.67,28.63,28.28,27.63,27.23]+273);
[nov23,ene327] = expmono(327,23.7,[06 18],[17
11],[19.97,20.32,21.05,22.1,24.13,24.83,26.08,26.47,27.17,27.5
2,28.22,28.57,29.27,29.62,30,30,29.63,29.28,28.63,28.23]+273);
[nov24,ene328] = expmono(328,23.7,[06 19],[17
11],[19,19.33,20.1,21.15,23.17,23.87,25.1,25.48,26.18,26.53,27
.23,27.58,28,28,28,28,27.662,27.27,26.62,26.22]+273);
[nov25,ene329] = expmono(329,23.7,[06 20],[17
11],[20,20.18,21.15,22.2,24.2,24.9,26.23,27,28.2,28.55,29.25,2
9.6,29.7,29.45,29,29,28.2,27.5,26.2,25.4]+273);

```

```

[nov26,ene330] = expmono(330,23.7,[06 20],[17
11],[20,20.7,22.1,22.8,24.2,24.9,26.23,27,28,28,28.25,28.6,29.
3,29.65,29.75,29.3,28.6,28.35,27.6,27.2]+273);
[nov27,ene331] = expmono(331,23.7,[06 21],[17
11],[21.02,21.37,22.07,22.42,23.12,23.47,24.27,25.03,26.22,26.
57,27.27,27.61,28.32,28.67,28.63,28.28,27.17,26.47,25.58,25.18
]+273);
[nov30,ene334] = expmono(334,23.7,[06 23],[17
11],[20.05,25.4,21.3,22.35,24.15,24.5,25.33,26.1,27.25,27.6,28
.3,28.65,29,29,29,29,28.1,27.4,26.55,26.15]+273);

energy11=(ene305+ene306+ene307+ene308+ene309+ene310+ene311+ene
312+ene313+ene314+ene315+ene316+ene317+ene318+ene319+ene320+en
e321+ene322+ene323+ene324+ene325+ene326+ene327+ene328+ene329+e
ne330+ene331+ene334)/28;
total11=energy11*30;
Energy11=[ene305,ene306,ene307,ene308,ene309,ene310,ene311,ene
312,ene313,ene314,ene315,ene316,ene317,ene31,ene319,ene320,ene
321,ene322,ene323,ene324,ene325,ene326,ene327,ene328,ene329,en
e330,ene331,ene334];
Nov=[1,2,3,4,5,6,7,8,9,10,11,12,13,14,15,16,17,18,19,20,21,22,
23,24,25,26,27,30];
%figure()
%plot(Nov,Energy11,'Linewidth',3),title('Energy in
November'),xlabel('November'),ylabel('Energy/Whr')

%

[dec1,ene335] = expmono(335,23.7,[06 24],[17
11],[20.07,20.4,21.13,21.8,23.13,23.8,25.07,25.4,26.13,26.8,11
.07,11.4,29.07,29.4,30,30,30,29.93,28.87,28.2]+273);
[dec2,ene336] = expmono(336,23.7,[06 24],[17
11],[20.07,20.4,21.07,21.4,22.2,23.2,25.07,25.4,26.07,26.4,27.
07,27.4,28.07,28.4,29,29,28.93,28.6,27.87,27.2]+273);
[dec3,ene337] = expmono(337,23.7,[06 25],[17
11],[20.17,20.83,22.17,22.83,24.08,24.42,25.17,25.83,27.25,28.
25,30,30,30,30,29.92,29.58,29,29,28.83,28.17]+273);
[dec4,ene338] = expmono(338,23.7,[06 26],[17
11],[20.2,20.87,22.2,22.87,24.2,24.87,26.1,26.43,27.1,27.43,28
.1,28.43,29,29,29.1,29.43,29.8,29.13,27.9,27.67]+273);
[dec6,ene340] = expmono(340,23.7,[06 27],[17
11],[20.23,20.9,22.12,22.45,23.23,23.9,25.23,25.9,27.12,27.45,
28.12,28.45,29,29,29,29,28.77,28.1,27,27]+273);
[dec7,ene341] = expmono(341,23.7,[06 28],[17
12],[20.27,20.93,22.13,22.47,23.27,23.93,25.13,25.47,26.13,26.
47,27.13,27.47,28,28,27.87,27.63,26.87,26.63,25.87,25.63]+273)
;
[dec8,ene342] = expmono(342,23.7,[06 28],[17
12],[20,20,20.23,20.9,22.23,22.9,24.23,24.9,26.13,26.47,27.23,
27.9,29,29,29,29,28.87,28.63,27.87,27.53]+273);

```

```

[dec9,ene343] = expmono(343,23.7,[06 29],[17
12],[18.3,18.97,20.3,20.97,24,24,24,24,24.3,24.97,26.15,26.48,
27,27,27.15,27.48,28.15,28.48,26.85,26.62]+273);
[dec10,ene344] = expmono(344,23.7,[06 30],[17
12],[20.17,20.5,21.33,22,23.33,24,25.17,25.5,26.33,27,28.17,28
.5,29,29,28.83,28.5,27.83,27.5,26.83,26.5]+273);
[dec11,ene345] = expmono(345,23.7,[06 30],[17
13],[21.17,21.5,22.17,22.5,23.33,24,25.17,25.5,26.17,26.5,27,2
7,27.17,27.5,28,28,27.83,27.5,26.83,26.5]+273);
[dec12,ene346] = expmono(346,23.7,[06 31],[17
13],[18.18,18.52,19.37,20.03,21.37,22.03,23.18,23.52,24.18,24.
52,25,25,25.18,25.52,26,26,25.88,25.47,25,25]+273);
[dec13,ene347] = expmono(347,23.7,[06 32],[17
13],[16.2,16.53,17.6,18.6,20.2,20.53,23.2,23.53,24.4,25.07,26,
26,26.2,26.53,27,27,26.8,26.47,25.6,24.93]+273);
[dec14,ene348] = expmono(348,23.7,[06 32],[17
14],[17.8,17.43,17.6,18.6,20.4,21.07,22.4,23.07,24.4,25.07,26.
2,26.53,27,27,26.8,26.47,25.8,25.47,24.8,24.47]+273);
[dec15,ene349] = expmono(349,23.7,[06 33],[17
14],[16,16,16.65,17.65,19.43,20.1,21.43,22.1,23.43,24.1,25.43,
26.1,27,27,26.78,26.45,25.78,25.45,23.78,23.45]+273);
[dec16,ene350] = expmono(350,23.7,[06 33],[17
14],[16.22,16.55,17.22,17.55,18.87,20.2,22.43,23.1,24.22,24.55
,25.22,25.55,26.22,26.55,27,27,26.88,26.45,25.57,24.9]+273);
[dec17,ene351] = expmono(351,23.7,[06 34],[17
15],[17.47,18.13,19.23,19.57,20.23,20.57,21.23,21.57,22.23,22.
57,23.47,24.13,25.23,25.57,25.77,25.43,24.77,24.43,25,25]+273)
;
[dec18,ene352] = expmono(352,23.7,[06 35],[17
15],[15.25,15.42,17,18.33,20.5,21.17,22.25,22.58,23.5,24.17,25
,25,25.25,25.58,25.75,25.42,25,25,24.75,24.42]+273);
[dec19,ene353] = expmono(353,23.7,[06 35],[17
16],[16.25,16.42,17.5,18.17,19.5,20.17,21.25,21.42,22.5,23.17,
24,24,24.25,24.42,24.75,24.48,24.25,24.42,24.5,23.83]+273);
[dec20,ene354] = expmono(354,23.7,[06 36],[17
16],[15.27,15.6,16.53,17.2,18.53,19.2,20.53,21.2,22.53,23.2,24
.27,24.6,25,25,24.73,24.4,23.73,23.4,23,23]+273);
[dec21,ene355] = expmono(355,23.7,[06 36],[17
17],[19,19,19,19,19,19,19.27,19.6,20.27,20.6,21.53,22.2,23,23,
23.27,23.6,24,24,23.73,23.4]+273);
[dec22,ene356] = expmono(356,23.7,[06 37],[17
17],[18,18,18.28,18.62,19.28,19.62,20.28,20.62,21.28,21.62,22.
28,22.62,23,23,23,23,22.82,22.48,21.82,21.48]+273);
[dec23,ene357] = expmono(357,23.7,[06 37],[17
18],[19.28,19.62,20,20,20.57,21.23,22.57,23.23,24.28,24.62,25,
25,25.28,25.62,26,26,25.43,24.77,23.82,23.48]+273);
[dec24,ene358] = expmono(358,23.7,[06 38],[17
18],[17.7,17.37,17.6,18.27,19.6,20.27,21.6,22.27,23.6,24.27,25
.6,26.27,27,27,27,27,26.7,26.67,25.7,25.67]+273);

```

```

[dec25,ene359] = expmono(359,23.7,[06 38],[17
18],[17.3,17.63,18,18,18.3,18.63,19.3,19.63,20.3,20.63,21.6,22
.27,23,23,23,23,22.4,21.73,20.7,20.37]+273);
[dec26,ene360] = expmono(360,23.7,[06 38],[17
19],[15.3,15.63,16,16,16.3,16.63,17.3,17.63,18.6,19.27,20.3,20
.63,21,21,21.3,21.63,22,22,22,22]+273);
[dec27,ene361] = expmono(361,23.7,[06 39],[17
20],[14,14,14,14,14.32,14.65,15.32,15.65,16.32,16.65,17.32,17.
65,18.32,18.65,19.32,19.65,18.68,19.45,19,19]+273);
[dec28,ene362] = expmono(362,23.7,[06 39],[17
20],[15,15,15.32,15.65,16.63,17.3,18.32,18.65,19.32,19.65,20.3
2,20.65,21.63,22.3,23,23,22.78,22.45,19.47,20.7]+273);
[dec29,ene363] = expmono(363,23.7,[06 40],[17
21],[14.33,14.67,15.67,16.33,17,17,17.33,17.67,18.33,18.67,19.
67,20.33,21.33,21.67,22.67,23.33,23.77,23.37,22.77,22.37]+273)
;
[dec30,ene364] = expmono(364,23.7,[06 40],[17
22],[14,14,14.67,15.33,16.67,17.33,18.67,19.33,21,22,23.33,23.
67,24.33,24.67,24.77,24.33,24,24,23.33,22.67]+273);
[dec31,ene365] = expmono(365,23.7,[06 40],[17
22],[13.67,14.33,15,15,15.33,15.67,16.67,16.33,18.33,18.67,19.
67,20.33,21.33,21.67,21.33,21.33,21.33,21.33,21.33,21.77,21.43]+273)
;

energy12=(ene335+ene336+ene337+ene338+ene340+ene341+ene342+ene
343+ene344+ene345+ene346+ene347+ene348+ene349+ene350+ene351+en
e352+ene353+ene354+ene355+ene356+ene357+ene358+ene359+ene360+e
ne361+ene362+ene363+ene364+ene365)/30;
total12=energy12*31;
Energy12=[ene335,ene336,ene337,ene338,ene340,ene341,ene342,ene
343,ene344,ene345,ene346,ene347,ene348,ene349,ene350,ene351,en
e352,ene353,ene354,ene355,ene356,ene357,ene358,ene359,ene360,e
ne361,ene362,ene363,ene364,ene365];
Dec=[1,2,3,4,6,7,8,9,10,11,12,13,14,15,16,17,18,19,20,21,22,23
,24,25,26,27,28,29,30,31];
%figure()
%plot(Dec,Energy12,'Linewidth',3),title('Energy in
December'),xlabel('December'),ylabel('Energy/Whr')

Month=[1,2,3,4,5,6,7,8,9,10,11,12];
TotalEnergy=[total1,
total2,total3,total4,total5,total6,total7,total8,total9,total11
0,total11,total12];
overyearm=sum(TotalEnergy)
%figure()
%plot(Month, TotalEnergy, 'Linewidth',3),title('Energy over
the year 2013'),xlabel('Months'),ylabel('Energy/Whr')

```

%%%%%%%%%%poly calculation starts:

```
[janp1, enep1] = exppoly(1, 23.7, [6 41], [17  
23], [12, 12.03, 12.35, 12.68, 13.35, 13.68, 14.875, 15.708, 17.375, 18.  
208, 19.875, 20.083, 22.375, 23.208, 24.35, 24.68, 24.65, 24.32, 22.65,  
22.32]+273);  
[janp3, enep3] = exppoly(3, 23.7, [6 41], [17  
24], [16, 16.03, 16.7, 17.37, 18.525, 19.025, 20.025, 20.525, 21.7, 22.3  
7, 23.35, 23.68, 24.35, 24.68, 24.825, 24.658, 24.325, 24.158, 23.3, 22.  
63]+273);  
[janp4, enep4] = exppoly(4, 23.7, [6 42], [17  
25], [16.35, 16.68, 17.7, 18.37, 19.35, 19.68, 20.7, 21.37, 22.7, 23.37,  
24.35, 24.68, 25, 25, 25, 25, 24.65, 24.32, 23.97, 23.65]+273);  
[janp5, enep5] = exppoly(5, 23.7, [6 42], [17  
26], [15.37, 15.7, 16, 16, 16.73, 17.4, 18.73, 19.4, 20.73, 21.4, 22.37, 2  
2.7, 23.37, 23.7, 24.37, 24.7, 25, 25, 24.63, 24.3]+273);  
[janp6, enep6] = exppoly(6, 23.7, [6 42], [17  
26], [15.37, 15.7, 16, 16, 16.73, 17.4, 18.73, 19.4, 20.37, 20.7, 21.73, 2  
2.4, 23, 23, 23, 23, 22.27, 21.6, 21, 21]+273);  
[janp7, enep7] = exppoly(7, 23.7, [6 42], [17  
27], [14.37, 14.7, 15.37, 15.7, 16, 16, 16.73, 17.4, 18.73, 19.4, 20, 20, 2  
0, 20, 20, 20, 20, 19.63, 19.3]+273);  
[janp8, enep8] = exppoly(8, 23.7, [6 42], [17  
28], [10, 10.03, 10.37, 10.7, 11.37, 11.7, 13.1, 14.1, 15.37, 15.7, 16.37  
, 16.7, 17, 17, 17, 17, 17, 17, 16.97, 15.97]+273);  
[janp9, enep9] = exppoly(9, 23.7, [6 42], [17  
29], [8.27, 7.93, 8.1, 9.1, 10.73, 11.4, 12.37, 12.7, 13, 13, 13.37, 13.7,  
14.37, 14.7, 15.37, 15.7, 16, 16, 14.63, 14.3]+273);  
[janp10, enep10] = exppoly(10, 23.7, [6 43], [17  
29], [7.38, 7.72, 8.38, 8.72, 9.38, 9.72, 10.77, 11.43, 12.77, 13.43, 14.  
77, 15.43, 16.38, 16.72, 17.38, 17.72, 17.63, 17.28, 16.62, 16.28]+273)  
;  
[janp15, enep15] = exppoly(15, 23.7, [6 43], [17  
33], [13.38, 13.72, 14.77, 15.43, 17.15, 18.15, 19.7, 20.43, 21.77, 22.4  
3, 25, 25, 25, 25, 25.38, 25.72, 25.62, 25.28, 24.62, 24.28]+273);  
[janp18, enep18] = exppoly(18, 23.7, [6 43], [17  
35], [14.38, 14.72, 15.92, 18.58, 20.77, 21.43, 22.38, 22.72, 23.77, 24.  
43, 25.77, 26.43, 27.38, 27.72, 28.38, 28.72, 28.23, 27.57, 26.23, 25.57  
]+273);  
[janp20, enep20] = exppoly(20, 23.7, [6 42], [17  
36], [17, 17, 17.38, 17.72, 18.77, 19.43, 20.38, 20.72, 21.38, 21.72, 22.  
38, 22.72, 23.77, 24.43, 25.38, 25.72, 26, 26, 25.23, 24.57]+273);  
[janp23, enep23] = exppoly(23, 23.7, [6 42], [17  
39], [15.63, 15.3, 15.73, 16.4, 17.73, 18.4, 19.73, 20.4, 21.73, 22.4, 23  
.73, 24.4, 26.1, 27.1, 28, 28, 27.27, 26.6, 25.63, 25.3]+273);
```

```
[janp25, enep25] = exppoly(25, 23.7, [6 41], [17
40], [12, 12, 12.4, 12.74, 14.2, 15.2, 16.4, 16.73, 17.4, 17.73, 19.2, 20.
2, 21.8, 22.47, 23, 23, 23, 22.93, 22.27, 21.93]+273);
[janp27, enep27] = exppoly(27, 23.7, [6 41], [17
41], [12, 12, 12.4, 12.75, 14.35, 15.4, 16.5, 16.85, 17.55, 17.9, 19.8, 20
.85, 22.3, 23, 23, 23, 23, 22.9, 22.2, 21.85]+273);
[janp29, enep29] = exppoly(29, 23.7, [6 40], [17
43], [12.65, 12.3, 12.4, 12.75, 14.8, 16.2, 18.5, 19.55, 21.1, 21.8, 23.2
, 23.9, 24.65, 25, 25, 25, 25, 24.9, 24.2, 23.85]+273);
[janp31, enep31] = exppoly(31, 23.7, [6 40], [17
44], [15.35, 15.7, 16.4, 16.75, 17.45, 17.8, 19, 19.7, 21.65, 22.7, 24.8,
25.85, 26.65, 27, 27.7, 27.95, 27.35, 26.8, 25.4, 23.85]+273);
```

```
energyp1=
(enep1+enep3+enep4+enep5+enep6+enep7+enep8+enep9+enep10+enep15
+enep18+enep20+enep23+enep25+enep27+enep29+enep31)/17;
totalp1=energyp1*31;
energyp1=[enep1, enep3, enep4, enep5, enep6, enep7, enep8, enep9, enep
10, enep15, enep18, enep20, enep23, enep25, enep27, enep29, enep31];
janp=[1, 3, 4, 5, 6, 7, 8, 9, 10, 15, 18, 20, 23, 25, 27, 29, 31];
```

⌘

```
[febp1, enep32] = exppoly(32, 23.7, [6 39], [17
45], [15.32, 15.67, 16.73, 17.43, 18.83, 19.53, 20.93, 21.63, 22, 22, 23.
13, 23.83, 23.38, 23.03, 23, 22.98, 22.28, 22, 22, 22]+273);
[febp2, enep33] = exppoly(33, 23.7, [6 39], [17
46], [15.32, 15.67, 16.73, 17.43, 18.83, 19.53, 20.93, 21.63, 23.03, 23.
73, 25.13, 26.08, 26.62, 26.97, 27, 26.98, 26.28, 25.93, 25.23, 24.88]+2
73);
[febp4, enep35] = exppoly(35, 23.7, [6 38], [17
47], [17.3, 17.65, 18.7, 19.4, 20.8, 21.5, 22.9, 23.6, 25.5, 26.55, 27.55
, 27.9, 28, 28, 28, 28, 27.3, 26.95, 26.25, 25.9, ]+273);
[febp9, enep40] = exppoly(40, 23.7, [6 35], [17
50], [18.25, 18.6, 19.3, 19.65, 21.05, 22.1, 23.4, 23.75, 24.45, 24.8, 26
.1, 26.7, 27, 27, 27.6, 27.95, 27.45, 27, 26.3, 25.95]+273);
[febp13, enep44] = exppoly(44, 23.7, [6 33], [17
53], [19, 19, 19.53, 20.23, 21.63, 22.33, 23.73, 24.43, 25.83, 26.53, 28.
03, 28.63, 29.52, 29.87, 30, 30, 30, 30, 29.33, 28.98]+273);
[febp21, enep52] = exppoly(52, 23.7, [6 27], [17
57], [19, 19, 19.43, 20.17, 21.63, 22.37, 23.83, 24.57, 26.03, 26.77, 28.
23, 28.97, 29.72, 30, 30, 30, 30, 29.72, 28.97, 28.23]+273);
[febp22, enep53] = exppoly(53, 23.7, [6 26], [17
58], [21.2, 21.6, 22.1, 22.6, 23.5, 24.6, 25.4, 25.8, 26.5, 26.8, 27.4, 27
.9, 28.7, 29.5, 31.8, 31.6, 31.2, 30.8, 30, 29.6]+273);
[febp23, enep54] = exppoly(54, 23.7, [6 26], [17
58], [19, 19, 19.4, 20.5, 21.5, 22.3, 24.2, 25.3, 27, 27.73, 29.2, 29.93, 3
1.4, 32.13, 32, 32, 32, 31.8, 31, 29.9]+273);
```



```
[febp25, enep56] = exppoly(56, 23.7, [6 24], [17
59], [21.1, 21.4, 22.54, 23.8, 25.45, 26.69, 27.2, 27.84, 28.64, 28.89, 2
9, 29, 29.64, 30.1, 30.79, 31.4, 31.93, 31.5, 30.07, 29.33]+273);
[febp27, enep58] = exppoly(58, 23.7, [6 22], [18
00], [20, 20, 20.8, 23, 26.23, 26.6, 27.33, 28.4, 29.43, 29.8, 30.53, 30.9
, 31.63, 32, 32.73, 32.53, 31.6, 30.87, 29.7, 29.33]+273);
[febp28, enep59] = exppoly(59, 23.7, [6 21], [18
01], [20, 20, 20.35, 21.45, 23.65, 24.35, 25.3, 25.79, 26.35, 27.65, 29.0
3, 29.77, 31.23, 31.97, 32.72, 32.92, 32.18, 31.82, 31.08, 30.72]+273);
```

```
energyp2=(enep32+enep33+enep35+enep40+enep44+enep52+enep53+ene
p54+enep56+enep58+enep59)/11;
totalp2= energyp2*28;
energyp2=[enep32, enep33, enep35, enep40, enep44, enep52, enep53, ene
p54, enep56, enep58, enep59];
febp = [1, 2, 4, 9, 13, 21, 22, 23, 25, 27, 28];
```

⌘

```
[marp1, enep60] = exppoly(60, 23.7, [6 21], [18
01], [20.03, 20.38, 21.23, 21.97, 23.43, 24.17, 25.63, 26.37, 25.83, 26.
57, 27.52, 27.88, 29.62, 29.98, 30.72, 31, 31, 30.82, 30.02, 29.43]+273)
;
[marp3, enep62] = exppoly(62, 23.7, [6 19], [18
02], [18.99, 19.65, 21.33, 22.73, 24.18, 24.55, 25.65, 26.75, 27.72, 28.
63, 29.67, 30.78, 31.665, 31.97, 32, 31.91, 31.13, 30.98, 30.63, 29.5]+2
73);
[marp5, enep64] = exppoly(64, 23.7, [6 17], [18
03], [21, 21.32, 22.15, 23.25, 25.45, 26.55, 28.5, 29.23, 30.35, 30.72, 3
1.45, 31.82, 32.55, 32.92, 33, 32.98, 32.35, 32, 32, 31.57]+273);
[marp7, enep66] = exppoly(66, 23.7, [6 15], [18
04], [22, 22.85, 25.05, 25.38, 26.12, 26.48, 27.22, 27.58, 28.32, 28.68,
29.83, 30.57, 32.03, 32.77, 32.42, 32.12, 32.28, 31.98, 31.12, 28.63]+2
73);
[marp9, enep68] = exppoly(68, 23.7, [6 13], [18
05], [20, 20, 20, 22.1, 26.5, 26.9, 28.37, 29.1, 30.28, 30.65, 31.38, 31.7
5, 32.48, 32.85, 33, 33, 31.28, 32, 31.53, 30.87]+273);
[marp11, enep70] = exppoly(70, 23.7, [6 11], [18
06], [24, 24, 24, 24.35, 25, 25, 25, 25, 25.35, 25.88, 27.05, 28.5, 29.33, 2
9.69, 31.34, 32.98, 32, 32, 31.35, 31]+273);
[marp12, enep71] = exppoly(71, 23.7, [6 10], [18
06], [24.8, 25.35, 25.99, 26, 26.23, 26.57, 27.28, 27.67, 28.43, 28.82, 2
9.58, 29.97, 31.47, 32.23, 30.23, 30, 29.97, 29.58, 29, 29]+273);
[marp13, enep72] = exppoly(72, 23.7, [6 09], [18
07], [24.88, 25.31, 25.98, 26.23, 27.13, 28.35, 30, 30, 31.65, 31.88, 32,
32, 31.65, 31, 31, 30.75, 29.97, 29.2, 27.83, 27.45]+273);
[marp15, enep74] = exppoly(74, 23.7, [6 08], [18
07], [25.2, 25.37, 26.9, 26.67, 29.1, 29.48, 30.25, 30.63, 31.4, 31.78, 3
2.55, 32.93, 33.7, 34, 34, 34, 34, 34, 33.7, 32.93]+273);
```

```

[marp16, enep75] = exppoly(75, 23.7, [6 07], [18
08], [25.22, 25.17, 25.93, 26.32, 27.08, 27.93, 29.23, 29.62, 30.38, 30.
77, 31.53, 31.92, 32, 32.2, 34.5, 34.88, 34.12, 34.27, 32, 32]+273);
[marp17, enep76] = exppoly(76, 23.7, [6 06], [18
08], [25, 25.15, 25.92, 26.3, 27.07, 27.9, 29.22, 29.6, 30.37, 30.75, 31,
31, 32.33, 33, 33, 32.8, 32.03, 30.95, 28.65, 27.5]+273);
[marp18, enep77] = exppoly(77, 23.7, [6 05], [18
09], [21.35, 21.27, 22.8, 23.57, 25.1, 25.43, 26.4, 27.17, 28.7, 29.47, 3
1, 31.77, 32.65, 33, 33, 33, 33, 32.33, 30.9, 30.52]+273);
[marp20, enep79] = exppoly(79, 23.7, [6 03], [18
09], [24.28, 24, 24, 24.5, 26.02, 26.4, 27.17, 27.55, 28.95, 30.1, 31.93,
32.7, 34.23, 35, 35, 34.85, 34.02, 34, 33.8, 32.65]+273);
[marp22, enep81] = exppoly(81, 23.7, [6 01], [18
10], [25, 25.06, 25.83, 26.22, 26.98, 27.37, 28.17, 29.03, 30.57, 31.33,
32, 32, 32.58, 32.97, 33, 33, 33, 32.2, 29.93, 29.17]+273);
[marp23, enep82] = exppoly(82, 23.7, [6 00], [18
11], [24.67, 25, 25, 25.4, 26.93, 27.9, 29, 29, 27.8, 28.95, 32, 32, 32.57,
32.95, 32.37, 32.9, 32.14, 31.75, 29.99, 29.6]+273);
[marp24, enep83] = exppoly(83, 23.7, [05 59], [18
11], [25, 25.02, 25.76, 26.35, 28.3, 29.22, 29.95, 30.32, 31.05, 31.42, 3
2, 32, 32.5, 32.62, 33.35, 33.72, 34, 33.98, 33.02, 32.43]+273);
[marp25, enep84] = exppoly(84, 23.7, [05 58], [18
11], [25, 25.03, 26.6, 27.8, 28.87, 29.8, 31.08, 31.47, 32.47, 33.23, 34.
3, 34.77, 35.53, 35.92, 36, 35.93, 35.17, 34.78, 34.02, 34]+273);
[marp26, enep85] = exppoly(85, 23.7, [05 57], [18
12], [26.65, 27, 27.76, 28.13, 28.95, 29.9, 32.2, 32.45, 33.43, 34.2, 35,
35, 35, 35.67, 36.05, 36.82, 35.8, 34.04, 33.3]+273);
[marp27, enep86] = exppoly(86, 23.7, [05 56], [18
12], [27, 27, 27.75, 28.13, 28.9, 29.57, 31.1, 31.887, 33.4, 33.58, 34.35
, 34.73, 35, 34.73, 34.27, 34, 34, 33.82, 33.04, 32]+273);
[marp29, enep88] = exppoly(88, 23.7, [05 54], [18
13], [25, 25, 25, 25.2, 26.73, 27.25, 28.03, 28.8, 30, 30, 30.95, 32.1, 33.
93, 34.7, 35.62, 36, 34.47, 34.98, 32.17, 32]+273);
[marp30, enep89] = exppoly(89, 23.7, [05 53], [18
13], [26.55, 26.93, 27.7, 28.25, 30.55, 31.23, 32, 32, 32, 32, 32, 32, 3
2, 33.8, 34.95, 35, 34.87, 34.1, 33.72]+273);
[marp31, enep90] = exppoly(90, 23.7, [05 52], [18
14], [26, 26, 26.68, 27, 27, 27.22, 27.98, 28.73, 30.133, 30.52, 31.28, 31
.67, 32, 32, 33.75, 34.9, 35, 35, 33.23, 32.57]+273);

```

```

energyp3=(enep60+enep62+enep64+enep66+enep68+enep70+enep71+ene
p72+enep74+enep75+enep76+enep77+enep79+enep81+enep82+enep83+en
ep84+enep85+enep86+enep88+enep89+enep90)/22;
totalp3=energyp3*31;
energyp3=[enep60, enep62, enep64, enep66, enep68, enep70, enep71, ene
p72, enep74, enep75, enep76, enep77, enep79, enep81, enep82, enep83, en
ep84, enep85, enep86, enep88, enep89, enep90];
marp=[1, 3, 5, 7, 9, 11, 12, 13, 15, 16, 17, 18, 20, 22, 23, 24, 25, 26, 27, 29, 3
0, 31];

```

⊘

```

[aprp3, enep93] = exppoly(93, 23.7, [05 49], [18
15], [25, 24.72, 24.42, 24.25, 26.65, 27.85, 30.25, 30.48, 31.28, 32.37,
33.48, 33.88, 34.68, 35.08, 35.88, 35.72, 34.83, 34.03, 32.72, 32.42]+2
73);
[aprp4, enep94] = exppoly(94, 23.7, [05 48], [18
15], [26, 26, 26.65, 27.15, 28.55, 30.5, 32.1, 32.9, 34.25, 34.65, 35.25,
35.65, 36, 36.1, 37.9, 38, 37.95, 37.65, 36.5, 35.7]+273);
[aprp5, enep95] = exppoly(95, 23.7, [05 47], [18
16], [26, 26, 27.9, 29, 29, 29.23, 30.07, 30.87, 32.47, 33.67, 34.43, 34.8
3, 35, 35, 35, 34.77, 33.97, 33.57, 32.77, 32.37]+273);
[aprp6, enep96] = exppoly(96, 23.7, [05 46], [18
16], [25.23, 25.87, 27.27, 28.07, 28.83, 29.23, 30.03, 30.43, 31.23, 32.
27, 33.43, 33.83, 34.63, 35.03, 35.83, 36.03, 34.97, 34.47, 33.53, 32.73
]+273);
[aprp7, enep97] = exppoly(97, 23.7, [05 45], [18
16], [27, 27, 28.23, 28.03, 29.63, 30.43, 32.03, 32.42, 33.22, 33.62, 34,
34, 34, 34.03, 35.63, 36, 35.97, 35.27, 34.43, 33.77]+273);
[aprp9, enep99] = exppoly(99, 23.7, [05 43], [18
17], [27, 27, 27.58, 27.98, 29.57, 30.37, 31.97, 32.38, 33.37, 34.17, 35.
38, 35.78, 36.58, 36.98, 36.22, 36, 36, 35.62, 34.82, 34.42]+273);
[aprp10, enep100] = exppoly(100, 23.7, [05 42], [18
18], [27.37, 27.77, 28.57, 28.97, 29, 29.17, 29.97, 30.37, 31.33, 32.13,
33, 33, 34.13, 34.93, 36.13, 37, 37, 36.63, 35.83, 35.43]+273);
[aprp11, enep101] = exppoly(101, 23.7, [05 41], [18
18], [27, 27, 27.55, 27.95, 28.75, 29.15, 29.95, 30.35, 31.15, 31.55, 32.
7, 33.5, 34.15, 34.95, 35, 34.7, 33.1, 33, 32.85, 32.45]+273);
[aprp12, enep102] = exppoly(102, 23.7, [05 40], [18
18], [27.33, 27.73, 29.07, 29.87, 30.73, 31.13, 32.87, 33.67, 35.27, 35.
53, 36.33, 36.73, 37, 37, 37, 36.87, 36.03, 35.77, 34.73, 33.93]+273);
[aprp13, enep103] = exppoly(103, 23.7, [05 39], [18
19], [26, 26, 28.07, 29.67, 30.72, 31.12, 31.92, 32.32, 33.12, 33.73, 35.
63, 36.43, 37, 37, 37, 37, 37, 36.68, 35.88, 35.48]+273);
[aprp14, enep104] = exppoly(104, 23.7, [05 38], [18
19], [27.6, 28.4, 29.5, 29.9, 30.7, 31.1, 32.8, 33.6, 35.2, 35.5, 35.7, 35
.3, 34.5, 34.1, 31.9, 30.7, 31.9, 32, 32, 32]+273);
[aprp15, enep105] = exppoly(105, 23.7, [05 37], [18
20], [26.28, 26.68, 27.48, 27.88, 29.37, 30, 30, 30.28, 31.08, 31.28, 32.
57, 33.37, 34.28, 34.68, 35, 34.92, 34.22, 33.82, 32.98, 32.52]+273);
[aprp16, enep106] = exppoly(106, 23.7, [05 37], [18
20], [24, 24, 24.48, 24.88, 25.68, 26.08, 27.77, 28.28, 29.08, 29.48, 30,
30, 30, 30, 30.68, 30.92, 30.22, 30, 29.92, 29.62]+273);
[aprp17, enep107] = exppoly(107, 23.7, [05 36], [18
21], [23, 23, 21.13, 19.53, 19.67, 20.07, 21.73, 22.5, 24.13, 25.4, 27.8,
29, 29.53, 29.12, 29.67, 30, 30, 29.83, 28.93, 28.53]+273);
[aprp18, enep108] = exppoly(108, 23.7, [05 35], [18
21], [25.25, 25.65, 26, 26, 26.65, 27.05, 27.85, 28.23, 29.05, 29.45, 30.
05, 30.65, 31.45, 31.85, 33, 32.85, 32.15, 31.85, 29.9, 30.1]+273);
[aprp19, enep109] = exppoly(109, 23.7, [05 34], [18
21], [25.23, 25.63, 26, 26, 27.27, 28.07, 28.83, 29.43, 31.07, 31.43, 32.
23, 32.63, 33, 33, 33.63, 34, 34, 33.87, 32.97, 32.67]+273);

```

```

[aprp20, enep110] = exppoly(110,23.7,[05 33],[18
22],[22.23,22.62,23.83,24.63,26.85,28,28,28.2,29.02,29.42,30.2
2,30.62,31,31,32.23,33,33,32.88,31.98,31.88]+273);
[aprp21, enep111] = exppoly(111,23.7,[05 32],[18
22],[26,26,26.8,27.6,28.62,29,29.8,30,30,30.4,31.03,31.6,32,32
,32,31.97,30.4,30,30,29.6]+273);
[aprp22, enep112] = exppoly(112,23.7,[05 31],[18
23],[23.18,23.6,24,24,24.6,24.98,24.32,24.17,24.98,25.38,26.18
,26.58,27,27,27.58,28,28,28,28,28]+273);
[aprp23, enep113] = exppoly(113,23.7,[05 31],[18
23],[23.37,24.17,25.77,26.57,27.6,27.98,28.78,29.17,29.98,30.7
7,32,32,32,32,31.42,31,32.57,32.73,31.03,30.62]+273);
[aprp24, enep114] = exppoly(114,23.7,[05 30],[18
23],[24,24,24.73,25.53,27.17,27.93,29.53,30.3,31.93,32.73,33.8
3,33.43,33.73,34.53,34.43,34.02,33.34,32.83,32.04,32]+273);
[aprp25, enep115] = exppoly(115,23.7,[05 29],[18
24],[27,27,27.7,28.5,29.57,29.95,31.5,32.27,32.95,33.35,34.15,
34.55,35,35,33.9,33.02,33.75,34.15,34.95,32.75]+273);
[aprp26, enep116] = exppoly(116,23.7,[05 28],[18
24],[27.6,28.07,29.17,29.73,30,30,30.73,32.12,31.93,32.33,33.1
3,33.53,34,34,34.53,34.93,35.73,36.13,35.24,33.8]+273);
[aprp27, enep117] = exppoly(117,23.7,[05 27],[18
25],[27.12,27.52,28.32,28.72,29.53,29.92,31,31,31,31,31,31,29.
73,28.13,28.03,28.87,30.43,31,31,30.68]+273);
[aprp28, enep118] = exppoly(118,23.7,[05 27],[18
25],[25.12,25.52,26,26,26.52,26.92,27.52,27.92,28,28.32,29.12,
29.52,30.63,31.43,32.52,32.92,32.38,31.88,31.08,30.78]+273);
[aprp29, enep119] = exppoly(119,23.7,[05 26],[18
26],[26,26,26.12,26.7,28.03,28.8,29.7,30.08,30.9,31.6,33.1,33.
5,34.13,34.7,35,35,35.7,35.9,35.1,34.1]+273);
[aprp30, enep120] = exppoly(120,23.7,[05 25],[18
26],[26,26.48,27.28,27.68,28.5,28.88,29.68,30.13,31.77,32.28,3
3.1,33.48,34.28,34.68,35,35,34.42,34,34,33.82]+273);

```

energyp4=

```

(enep93+enep94+enep95+enep96+enep97+enep99+enep100+enep101+ene
p102+enep103+enep104+enep105+enep106+enep107+enep108+enep109+e
nep110+enep111+enep112+enep113+enep114+enep115+enep116+enep117
+enep118+enep119+enep120)/22;

```

totalp4=energyp4*30;

```

energyp4=[enep93, enep94, enep95, enep96, enep97, enep99, enep100, en
ep101, enep102, enep103, enep104, enep105, enep106, enep107, enep108,
enep109, enep110, enep111, enep112, enep113, enep114, enep115, enep11
6, enep117, enep118, enep119, enep120];

```

```

aprp=[3, 4, 5, 6, 7, 9, 10, 11, 12, 13, 14, 15, 16, 17, 18, 19, 20, 21, 22, 23, 24
, 25, 26, 27, 28, 29, 30];

```

⌘

```

[mayp1, enep121] = exppoly(121, 23.7, [05 25], [18
27], [29, 29, 29.28, 29.68, 30, 30, 30.68, 31.1, 32.77, 33.27, 35, 35, 35, 3
5, 35.97, 36.98, 36.62, 35.9, 35.62, 34.82]+273);
[mayp2, enep122] = exppoly(122, 23.7, [05 24], [18
27], [29, 29, 29.26, 29.67, 30.97, 31.73, 32.68, 33, 33, 33.27, 34.13, 34.
93, 36, 36, 36, 36, 36, 35.94, 35.13, 34.73]+273);
[mayp3, enep123] = exppoly(123, 23.7, [05 23], [18
28], [30, 30, 30.25, 30.65, 31.47, 31.85, 32.65, 33.07, 34.7, 35.25, 36, 3
6, 36, 36, 36, 36, 35.95, 35.25, 34.85]+273);
[mayp4, enep124] = exppoly(124, 23.7, [05 22], [18
28], [29, 29, 29, 29, 29.9, 30.67, 31.63, 32.02, 32.83, 33.23, 34.98, 33.5
7, 33, 33, 32.13, 31.3, 30.47, 30, 30, 29.64]+273);
[mayp5, enep125] = exppoly(125, 23.7, [05 22], [18
29], [21.03, 21.43, 21.77, 21.47, 21.45, 21.83, 23.9, 25.02, 25.83, 25.7
, 29, 29, 29.23, 29.63, 30, 30, 30, 29.94, 28.33, 27.77]+273);
[mayp6, enep126] = exppoly(126, 23.7, [05 21], [18
29], [25, 25, 25, 25, 24.57, 24.18, 22.77, 22, 21.17, 21.23, 22, 22, 22.43,
23.23, 24.42, 24.83, 25, 25, 25, 25]+273);
[mayp7, enep127] = exppoly(127, 23.7, [05 21], [18
29], [23, 23, 23.65, 24.85, 27.3, 28.45, 29, 29, 29.83, 29.77, 29, 29, 28.4
5, 28.15, 26.42, 26.83, 27.62, 28, 28, 27.57]+273);
[mayp8, enep128] = exppoly(128, 23.7, [05 20], [18
30], [27, 27.23, 28.2, 28.6, 29.42, 29.8, 30.6, 30.98, 31.82, 32.22, 33, 3
3, 33, 33, 32.6, 32.18, 30, 27, 27, 27.2]+273);
[mayp9, enep129] = exppoly(129, 23.7, [05 19], [18
30], [24.98, 25.38, 26.37, 27.17, 28, 28, 28, 28, 27.2, 27, 27, 27.8, 29, 29
, 29, 29, 29.58, 29.98, 30, 29.63]+273);
[mayp10, enep130] = exppoly(130, 23.7, [05 19], [18
31], [26.98, 27.38, 28.18, 28.58, 29.23, 29.78, 30.58, 30.98, 31.8, 32, 3
2, 32.4, 33.18, 33.32, 34.38, 34.8, 34.42, 33.02, 32.22, 32.82]+273);
[mayp11, enep131] = exppoly(131, 23.7, [05 18], [18
31], [29, 28.63, 28.5, 29.7, 31.38, 31.77, 32, 32, 32, 32.18, 32.97, 33.38
, 34.17, 34.6, 34.63, 34.22, 32.3, 31.1, 31.77, 31.83]+273);
[mayp12, enep132] = exppoly(132, 23.7, [05 18], [18
32], [28, 27.63, 27, 27, 27.38, 27.77, 28.57, 28.95, 29.57, 30.27, 27.13,
27, 27.17, 27.6, 28.73, 29.57, 30, 30, 30, 30]+273);
[mayp16, enep136] = exppoly(136, 23.7, [05 16], [18
34], [25, 25, 25, 25, 25, 25, 24.47, 24.08, 24, 24, 24, 24, 24, 24, 24, 24,
24, 24, 24.73, 25]+273);
[mayp17, enep137] = exppoly(137, 23.7, [05 15], [18
34], [24.98, 25.32, 26.12, 26.52, 27.33, 27.72, 28.52, 28.9, 29, 29.13, 2
9.92, 30.33, 31.12, 31.72, 32, 32, 32, 32, 30.28, 31]+273);
[mayp18, enep138] = exppoly(138, 23.7, [05 15], [18
35], [26, 26.32, 27.12, 27.52, 28.67, 29.43, 30, 30, 31.13, 32, 32, 32.33,
33, 33, 31.73, 30.07, 28.48, 28.02, 28.72, 28.88]+273);
[mayp19, enep139] = exppoly(139, 23.7, [05 15], [18
35], [26, 26.63, 28.12, 28.52, 29.67, 30.43, 31.52, 31.9, 32.57, 33, 33, 3
3.33, 34, 34, 34.32, 34.73, 35, 35, 34.33, 33.77]+273);
[mayp20, enep140] = exppoly(140, 23.7, [05 14], [18
36], [28.98, 29, 29.1, 29.5, 30.32, 30.7, 31.5, 31.88, 32, 31.77, 30.2, 28
.73, 26, 26, 26, 26, 26, 26, 26.7, 27]+273);

```

```

[mayp21, enep141] = exppoly(141, 23.7, [05 14], [18
36], [27, 27, 27.2, 27.63, 28, 28, 28.8, 29, 29, 29, 29, 29, 29, 29.13, 30, 30
, 29.7, 29.27, 28.4, 28]+273);
[mayp22, enep142] = exppoly(142, 23.7, [05 13], [18
37], [24.22, 24.32, 25.18, 25.62, 26, 26, 26, 26.28, 27, 27, 27.38, 27.82,
27.32, 27, 27, 27, 27.68, 27.72, 28, 28]+273);
[mayp23, enep143] = exppoly(143, 23.7, [05 13], [18
37], [27, 26.1, 24, 24, 24.48, 24.97, 25, 25, 25, 25, 25, 26, 25, 25.12, 25.9
8, 26.83, 28, 28, 28, 28]+273);
[mayp24, enep144] = exppoly(144, 23.7, [05 13], [18
38], [24, 24, 24, 24, 24.48, 24.92, 25, 25.57, 27.17, 28.03, 29, 29, 29, 29,
29, 28.17, 26.72, 26.28, 26, 25.98]+273);
[mayp25, enep145] = exppoly(145, 23.7, [05 13], [18
38], [27, 27, 27.18, 27.62, 28.48, 28.92, 29, 29.23, 30, 30, 30.77, 31.63,
32, 32, 32, 32, 31.72, 31.28, 30.42, 29.98]+273);
[mayp26, enep146] = exppoly(146, 23.7, [05 12], [18
39], [27, 27, 27.17, 27.6, 28.47, 28.9, 29.77, 30.22, 31.07, 31.5, 32.36,
32.8, 33, 33, 33, 33, 33, 33, 33, 33]+273);
[mayp27, enep147] = exppoly(147, 23.7, [05 12], [18
39], [28, 28.3, 29.17, 29.6, 30.93, 31.8, 32.77, 33, 33, 33, 33, 33, 33, 29.65,
29.05, 29.93, 29.4, 29.73, 28.65, 28.57, 29]+273);
[mayp28, enep148] = exppoly(148, 23.7, [05 12], [18
40], [27, 27, 27.17, 27.6, 28.47, 28.9, 29.77, 30.22, 31, 31, 31.37, 31.8,
32.67, 32.9, 32.03, 31.6, 30.73, 30.3, 30, 30]+273);
[mayp29, enep149] = exppoly(149, 23.7, [05 12], [18
40], [28, 28, 28, 28, 28, 28, 28.77, 29.43, 31, 31, 31, 31, 31, 31, 30.9, 30.03, 3
0, 30, 30, 30, 30]+273);
[mayp30, enep150] = exppoly(150, 23.7, [05 11], [18
40], [26.85, 27.28, 28.3, 29.17, 30.45, 30.88, 29.5, 29, 29.05, 29.48, 29
.65, 29.22, 29, 28.95, 28.05, 28, 27.75, 27.42, 27, 27]+273);
[mayp31, enep151] = exppoly(151, 23.7, [05 11], [18
41], [27, 27, 27, 27, 27.45, 27.88, 28.75, 28.8, 27.95, 27.52, 27, 27, 27.8
2, 28, 28, 27.23, 25.5, 24.63, 24, 24]+273);

```

```

energyp5=(enep121+enep122+enep123+enep124+enep125+enep126+enep
127+enep128+enep129+enep130+enep131+enep132+enep136+enep137+en
ep138+enep139+enep140+enep141+enep142+enep143+enep144+enep145+
enep146+enep147+enep148+enep149+enep150+enep151)/28;
totalp5=energyp5*31;
energyp5=[enep121, enep122, enep123, enep124, enep125, enep126, enep
127, enep128, enep129, enep130, enep131, enep132, enep136, enep137, en
ep138, enep139, enep140, enep141, enep142, enep143, enep144, enep145,
enep146, enep147, enep148, enep149, enep150, enep151];
mayp=[1, 2, 3, 4, 5, 6, 7, 8, 9, 10, 11, 12, 16, 17, 18, 19, 20, 21, 22, 23, 24, 25
, 26, 27, 28, 29, 30, 31];

```

⊘

```

[junep1, enep152] = exppoly(152, 23.7, [05 11], [18
41], [25, 25.57, 27.15, 27.58, 28.9, 29.77, 30.75, 31.18, 32.05, 32.48, 3
3, 33, 33, 33, 33, 32.62, 31.75, 31.32, 31, 31]+273);
[junep2, enep153] = exppoly(153, 23.7, [05 11], [18
42], [28, 28, 28.15, 28.59, 29.45, 29.89, 31.5, 32, 32.05, 32.48, 33, 33, 3
3, 33.08, 33.95, 34.38, 34.5, 33.63, 31.9, 31.03]+273);
[junep3, enep154] = exppoly(154, 23.7, [05 11], [18
42], [28.13, 28.65, 29.15, 29.59, 30.9, 31.77, 32.75, 33, 33.05, 33.49, 3
4.35, 34.79, 35, 35.09, 35.95, 36, 35.75, 35.31, 34.45, 34.01]+273);
[junep4, enep155] = exppoly(155, 23.7, [05 11], [18
43], [28.15, 28.29, 29.3, 30.17, 31, 31, 31, 31.19, 32, 32, 32.35, 32.79, 3
3.65, 34, 34, 33.61, 32, 30.26, 30.1, 30.97]+273);
[junep5, enep156] = exppoly(156, 23.7, [05 11], [18
43], [29.43, 29.65, 30.15, 30.59, 31, 31, 31.75, 32.19, 33, 33, 33, 33, 33,
32.83, 31.1, 31, 31, 31, 31, 31]+273);
[junep6, enep157] = exppoly(157, 23.7, [05 11], [18
43], [27, 27.57, 29.15, 29.59, 30.45, 30.89, 31.75, 32, 31.95, 31.51, 31,
31, 31.65, 32, 32, 31.23, 30, 30, 30.55, 30.99]+273);
[junep7, enep158] = exppoly(158, 23.7, [05 11], [18
44], [27, 27, 27, 27, 27.45, 27.89, 27.25, 27, 27, 27, 27, 27, 27, 27.65, 28, 28,
28, 28, 28, 28, 28]+273);
[junep8, enep159] = exppoly(159, 23.7, [05 11], [18
44], [27.43, 27.65, 28.15, 28.59, 29.9, 30.77, 31.75, 32, 32.05, 32.49, 3
3.35, 33.79, 34, 34, 34, 33.23, 31.75, 31.31, 31, 31]+273);
[junep9, enep160] = exppoly(160, 23.7, [05 11], [18
45], [28, 28.29, 29.15, 29.59, 30.45, 30.89, 31.75, 32, 31.95, 31.51, 31,
31, 31.65, 32.17, 33.9, 34, 33.5, 32.63, 32, 32]+273);
[junep10, enep161] = exppoly(161, 23.7, [05 11], [18
45], [28.85, 29, 29.15, 29.59, 30, 30, 30.75, 31.19, 32, 32, 32.35, 32.79,
33, 32.95, 32.52, 32.3, 31.87, 31.65, 31.22, 31]+273);
[junep11, enep162] = exppoly(162, 23.7, [05 11], [18
45], [29, 29.43, 30.73, 31.38, 32.45, 32.89, 33.75, 34, 34.05, 34.49, 35,
35, 35, 35, 34.61, 33.75, 33.31, 32.45, 32.01]+273);
[junep12, enep163] = exppoly(163, 23.7, [05 11], [18
46], [29.15, 29, 29, 29, 29.9, 30.77, 31.75, 32.19, 33.05, 33.49, 34, 34, 3
4, 34.09, 34.95, 34.61, 34, 34, 34, 34]+273);
[junep13, enep164] = exppoly(164, 23.7, [05 11], [18
46], [29, 29, 29, 29, 29.45, 29.89, 31.5, 32.19, 33.05, 33.49, 34, 34, 34.6
5, 34.91, 34.05, 33.61, 33, 33, 33, 33]+273);
[junep14, enep165] = exppoly(165, 23.7, [05 11], [18
46], [28.15, 28.29, 29.15, 29.59, 30, 30, 30.75, 31, 31.05, 31.49, 30.6, 2
8.86, 28.65, 29, 29, 29.39, 30.25, 30.69, 31, 31]+273);
[junep15, enep166] = exppoly(166, 23.7, [05 11], [18
47], [28, 28.29, 29.15, 29.59, 30.45, 30.89, 31, 31.19, 32.05, 32.49, 33,
33, 33.65, 34.09, 34.95, 34.23, 33, 33, 33, 33]+273);
[junep16, enep167] = exppoly(167, 23.7, [05 11], [18
47], [29, 29.29, 30.15, 30.59, 31.45, 31.89, 32, 32, 32, 32, 32, 32, 32.65,
33.09, 33.95, 34, 34, 34, 33.45, 33.01]+273);
[junep17, enep168] = exppoly(168, 23.7, [05 11], [18
47], [30.15, 30.29, 31, 31, 31.27, 31.53, 32.05, 32.31, 32.83, 33.09, 33.
61, 33.87, 33.35, 33, 33, 33.39, 33.75, 33.31, 33, 33]+273);

```

```

[junep18, enep169] = exppoly(169, 23.7, [05 12], [18
47], [31, 31, 31.15, 31.59, 32.45, 32.89, 33.5, 33.79, 34.37, 34.66, 35, 3
5, 35.65, 36, 36, 36, 35.5, 34.63, 34, 34]+273);
[junep19, enep170] = exppoly(170, 23.7, [05 12], [18
48], [30, 30.29, 31, 31, 31, 31, 31, 31, 31, 31, 31, 31.65, 32, 32, 31.61,
30, 30, 29.45, 29.01]+273);
[junep20, enep171] = exppoly(171, 23.7, [05 12], [18
48], [27, 29.29, 28.3, 29.17, 30, 30, 30.75, 31.19, 32, 32, 32.35, 32.79, 3
1.7, 30.91, 30.05, 30.39, 31.25, 31.69, 31.45, 31.01]+273);
[junep21, enep172] = exppoly(172, 23.7, [05 12], [18
48], [29, 29.29, 30.15, 30.59, 31.45, 31.89, 32.75, 33.19, 34.05, 34.49,
35.35, 35.79, 36, 36, 36, 36, 35.75, 35.31, 34.45, 34.01]+273);
[junep22, enep173] = exppoly(173, 23.7, [05 12], [18
48], [27, 27, 27, 27, 28.8, 30.54, 31, 31, 31.08, 31.73, 33.03, 33.68, 34, 3
4, 34, 33.61, 32.75, 32.31, 32, 32]+273);
[junep23, enep174] = exppoly(174, 23.7, [05 13], [18
49], [29, 29, 29.15, 29.59, 30.9, 31.77, 32.75, 33.19, 34, 34, 34.35, 34.7
9, 35, 35, 35, 35, 34.75, 34.31, 34, 34]+273);
[junep24, enep175] = exppoly(175, 23.7, [05 13], [18
49], [28, 28.29, 29, 29, 29.45, 29.89, 32.25, 33, 33, 33, 33, 33, 33, 33.09,
33.95, 34.39, 34.75, 34.31, 33.45, 33.01]+273);
[junep25, enep176] = exppoly(176, 23.7, [05 13], [18
49], [27, 27.29, 28.08, 28.3, 28.73, 28.95, 29, 29, 29, 29, 29, 29, 29, 29.0
9, 29.95, 29.61, 29, 29, 29, 29]+273);
[junep26, enep177] = exppoly(177, 23.7, [05 13], [18
49], [27.85, 28, 28.15, 28.59, 29.9, 29.77, 31, 30.81, 30.1, 30.97, 32, 32
, 30.05, 29, 29, 29, 29, 29, 29, 29]+273);
[junep27, enep178] = exppoly(178, 23.7, [05 14], [18
49], [28, 28, 28, 28, 28.9, 28.77, 39, 30.37, 31.8, 30.07, 28, 28, 29.3, 29.
91, 29.05, 29.38, 30, 30, 30, 30]+273);
[junep28, enep179] = exppoly(179, 23.7, [05 14], [18
49], [28, 28.28, 29, 29, 29.9, 29.77, 29.75, 29, 28.95, 28.52, 28, 28, 28, 2
7.97, 27.05, 27, 27, 27, 27, 27]+273);
[junep29, enep180] = exppoly(180, 23.7, [05 14], [18
49], [26.15, 26, 27.15, 27.59, 27, 27, 27.75, 28, 28, 28, 27.65, 27.21, 27,
27, 27, 27.77, 28.5, 27.63, 27, 27]+273);
[junep30, enep181] = exppoly(181, 23.7, [05 15], [18
49], [27.85, 28, 28, 28, 28, 28, 28.75, 29.18, 30, 30, 30, 30, 30, 30, 30, 30,
30, 30, 30, 30]+273);

```

```

energyp6=(enep152+enep153+enep154+enep155+enep156+enep157+enep
158+enep159+enep160+enep161+enep162+enep163+enep164+enep165+en
ep166+enep167+enep168+enep169+enep170+enep171+enep172+enep173+
enep174+enep175+enep176+enep177+enep178+enep179+enep180+enep18
1)/30;

```

```

totalp6=energyp6*30;

```

```

energyp6=[enep152, enep153, enep154, enep155, enep156, enep157, enep
158, enep159, enep160, enep161, enep162, enep163, enep164, enep165, en
ep166, enep167, enep168, enep169, enep170, enep171, enep172, enep173,
enep174, enep175, enep176, enep177, enep178, enep179, enep180, enep18
1];

```



```
june=[1,2,3,4,5,6,7,8,9,10,11,12,13,14,15,16,17,18,19,20,21,22,23,24,25,26,27,28,29,30];
```

```
%
```

```
[julyp1, enep182] = exppoly(182,23.7,[05 15],[18  
49],[27,27.43,28,28,28.86,29,29,29.43,30.72,31.58,31.58,30,30.  
86,30,30.86,31.43,31.98,32,31.43,31]+273);  
[julyp2, enep183] = exppoly(183,23.7,[05 15],[18  
49],[28,28,28,28,28.86,29,30.72,31.15,32.33,32.76,33,33,31.83,  
29.57,31.86,32.72,34,33.95,32.66,31.8]+273);  
[julyp3, enep184] = exppoly(184,23.7,[05 16],[18  
49],[28,28.43,29,29,29.86,30,30.28,30.42,30.7,30.84,31.41,31.8  
4,31.96,31.57,31.04,31.47,31.93,31.96,31.04,31]+273);  
[julyp4, enep185] = exppoly(185,23.7,[05 16],[18  
49],[28,28.43,29.29,29.58,30.87,31.73,29.99,28.69,29.55,29.65,  
29.85,29.95,29.23,28.66,28.57,28.14,28.49,28.92,28.92,29]+273)  
;  
[julyp5, enep186] = exppoly(186,23.7,[05 16],[18  
49],[27.86,28.07,28.7,28.91,29.55,29.98,30.84,31.27,32.13,32.0  
6,32.86,33.72,33.832,33.888,34,33.584,32.758,32.345,31.502,31.  
089]+273);  
[julyp6, enep187] = exppoly(187,23.7,[05 17],[18  
49],[27.96,28.39,29.25,29.68,31.4,31.86,31,31.43,32.29,32.72,3  
2.72,32.29,31.9,31.93,32.02,31.77,31.2,31.1,30.6,29.96]+273);  
[julyp7, enep188] = exppoly(188,23.7,[05 17],[18  
49],[28,28,28,28,29.72,30.58,32.3,32.73,32.73,31.87,31.87,32.7  
3,33,33,33,33,32.57,32.14,32,31.57]+273);  
[julyp8, enep189] = exppoly(189,23.7,[05 17],[18  
49],[28,28.21,28.63,28.84,29.91,30.77,31.63,32.06,32.92,32.94,  
33.39,33.82,34,34,34,34,34,34,33.14,32.71]+273);  
[julyp9, enep190] = exppoly(190,23.7,[05 18],[18  
49],[29,29.43,30,30,28.28,28,30.6,31,31,31,31.86,32.29,33.15,3  
3,33,33,33,33,33,33]+273);  
[julyp10, enep191] = exppoly(191,23.7,[05 18],[18  
49],[29,29.43,30,30,30,30,30.86,31.29,32.15,32,32,32,32.86,32.  
43,32,32,31.57,31.14,31,31]+273);  
[julyp11, enep192] = exppoly(192,23.7,[05 19],[18  
49],[28,28,28.43,28.86,30.58,31.44,31,31.86,33,33,33,33,33,33,  
32.57,32.14,31.57,31.14,31,31]+273);  
[julyp12, enep193] = exppoly(193,23.7,[05 19],[18  
49],[27,27,27,27,27.86,28.29,28,28.43,29.15,29.58,30.87,31.73,  
32,32.43,33.29,32.86,32,31.57,30.74,30.28]+273);  
[julyp13, enep194] = exppoly(194,23.7,[05 20],[18  
48],[27,27.43,27.86,27.43,27,27.43,28,28.86,29.29,28.86,29.29,  
31.01,30.15,30,30,30,30,30.43,31,31]+273);  
[julyp14, enep195] = exppoly(195,23.7,[05 20],[18  
48],[28,28,28.43,28.86,28,28,28.86,29.29,30.58,31.44,32.73,33.  
16,33,33,32.9,31.6,30,30,30,30]+273);
```

```

[julyp15, enep196] = exppoly(196, 23.7, [05 20], [18
48], [29, 29, 29, 29, 29.86, 30, 30, 30.43, 31.29, 31.72, 32.58, 33.01, 33.
87, 33.44, 31.72, 32, 32, 32, 31.14, 31]+273);
[julyp16, enep197] = exppoly(197, 23.7, [05 21], [18
48], [28, 28, 28.43, 28.86, 29, 29, 29.86, 30, 30.43, 30.86, 31.72, 32, 32.
86, 33, 32.96, 32.53, 32, 32, 31.14, 31]+273);
[julyp17, enep198] = exppoly(198, 23.7, [05 21], [18
48], [29, 28.57, 28.14, 29, 29.43, 30, 30, 30.43, 30.86, 31.72, 32.15, 33.
01, 33, 33, 33, 33, 32.43, 31.57, 31]+273);
[julyp18, enep199] = exppoly(199, 23.7, [05 22], [18
47], [28, 28.56, 27, 27, 27, 27, 28.72, 29.58, 31.3, 30.87, 31.43, 31.86, 3
2.43, 32.86, 33, 33, 32.86, 32.43, 31.14, 31]+273);
[julyp19, enep200] = exppoly(200, 23.7, [05 22], [18
47], [28, 28.43, 28.43, 28, 28.43, 28, 28.86, 29.29, 30.15, 30, 30.43, 30.
86, 31.72, 32, 32, 31.5, 31, 31, 31, 31]+273);
[julyp20, enep201] = exppoly(201, 23.7, [05 23], [18
47], [28, 28, 28.43, 28.86, 29, 29.43, 30, 30, 30, 30, 31.72, 32, 33.72, 32.
42, 30.26, 29.4, 29, 29, 29.86, 30]+273);
[julyp21, enep202] = exppoly(202, 23.7, [05 23], [18
46], [29, 29, 29.43, 29.86, 30.72, 31.15, 32.01, 32.44, 33.3, 33.73, 34, 3
4, 34.86, 35, 34.57, 34.14, 33.28, 32.85, 31.99, 32]+273);
[julyp22, enep203] = exppoly(203, 23.7, [05 23], [18
46], [28, 28.43, 28.43, 28, 28.43, 28, 28.86, 29.29, 30.15, 30, 30.43, 30.
86, 31.72, 32, 32, 31.5, 31, 31, 31, 31]+273);
[julyp23, enep204] = exppoly(204, 23.7, [05 24], [18
46], [29, 29.43, 30, 30, 31.72, 32.15, 33.01, 33, 33.43, 33.865, 34, 34, 34
, 34, 34, 34, 34, 34, 33.57]+273);
[julyp24, enep205] = exppoly(205, 23.7, [05 24], [18
45], [29, 29.43, 30.29, 30.72, 30.96, 31.06, 31, 31, 31.43, 31.86, 32.72,
33.15, 33, 33.86, 35, 35, 34.57, 34.14, 33.28, 33]+273);
[julyp25, enep206] = exppoly(206, 23.7, [05 25], [18
45], [29, 28.57, 28.57, 29, 29.86, 30, 30, 30.43, 31.29, 31.72, 32.58, 33.
01, 33, 33, 33, 33, 32.86, 32.43, 31.14, 31]+273);
[julyp26, enep207] = exppoly(207, 23.7, [05 25], [18
45], [28, 28, 28.43, 28.86, 28.33, 28, 28, 28.43, 29, 29, 29, 29, 29, 29.
86, 30.29, 31.15, 30.72, 29.86, 29.43]+273);
[julyp27, enep208] = exppoly(208, 23.7, [05 26], [18
44], [27, 27, 27, 27, 28.72, 29, 29.86, 29.43, 28.57, 28.14, 28.14, 28.14,
28.14, 28.14, 28.14, 28.14, 28.14, 28.14]+273);
[julyp28, enep209] = exppoly(209, 23.7, [05 26], [18
43], [27, 27.43, 28, 28, 28, 28, 27.14, 27, 27, 27, 27, 27, 28.72, 29, 29.86,
29.43, 29, 29, 28.57, 28.14]+273);
[julyp29, enep210] = exppoly(210, 23.7, [05 27], [18
43], [27, 27, 27.43, 27.86, 27.86, 27.43, 28, 28, 28.43, 28.86, 29.72, 30.
15, 31.01, 31, 31.86, 31.43, 31, 31.43, 31.43, 31]+273);
[julyp30, enep211] = exppoly(211, 23.7, [05 27], [18
42], [28, 28, 28, 28, 28.86, 29.32, 29, 29.86, 31.58, 31, 31.43, 31.86, 32,
32, 32, 31.44, 29.42, 30, 30, 30]+273);
[julyp31, enep212] = exppoly(212, 23.7, [05 27], [18
42], [28, 28, 28.43, 28.86, 28.33, 28, 28, 28.43, 29, 29, 29, 29, 29, 29.
86, 30.29, 31.15, 30.72, 29.86, 29.43]+273);

```

```

energyp7=(enep182+enep183+enep184+enep185+enep186+enep187+enep
188+enep189+enep190+enep191+enep192+enep193+enep194+enep195+en
ep196+enep197+enep198+enep199+enep200+enep201+enep202+enep203+
enep204+enep205+enep206+enep207+enep208+enep209+enep210+enep21
1+enep212)/31;
totalp7=energyp7*31;
energyp7=[enep182, enep183, enep184, enep185, enep186, enep187, enep
188, enep189, enep190, enep191, enep192, enep193, enep194, enep195, en
ep196, enep197, enep198, enep199, enep200, enep201, enep202, enep203,
enep204, enep205, enep206, enep207, enep208, enep209, enep210, enep21
1, enep212];
julyp=[1, 2, 3, 4, 5, 6, 7, 8, 9, 10, 11, 12, 13, 14, 15, 16, 17, 18, 19, 20, 21, 2
2, 23, 24, 25, 26, 27, 28, 29, 30, 31];

```

⊘

```

[augp2, enep214] = exppoly(214, 23.7, [05 28], [18
41], [29, 29, 29, 29, 30.04, 30.09, 30.99, 32, 32.43, 32.86, 32.26, 33.69,
32.83, 33.05, 33.91, 33.79, 33.43, 33, 32.57, 32.14]+273);
[augp3, enep215] = exppoly(215, 23.7, [05 29], [18
40], [29.05, 29.61, 30, 30, 30, 30.06, 30.97, 31, 31.15, 31.56, 32, 32, 32,
32.06, 32.9, 33, 32.86, 32.45, 32, 32]+273);
[augp4, enep216] = exppoly(216, 23.7, [05 29], [18
40], [29, 29, 29.4, 29.81, 30.63, 31, 31, 31, 31, 31, 31.4, 30.81, 32, 32, 32
, 31.7, 31.13, 31.55, 32, 32]+273);
[augp5, enep217] = exppoly(217, 23.7, [05 30], [18
39], [29, 29, 29, 29, 30.29, 31.26, 31.9, 32.31, 33, 33, 33.4, 33.81, 34, 34
, 34, 33.4, 32, 32, 31.4, 30.57]+273);
[augp6, enep218] = exppoly(218, 23.7, [05 30], [18
38], [27, 27, 27, 27, 27, 27, 27, 27, 27.15, 27.56, 27.6, 27.18, 27, 27, 27, 2
7, 27, 27, 27.3, 27.71]+273);
[augp7, enep219] = exppoly(219, 23.7, [05 31], [18
37], [27.18, 27.58, 28.41, 28.83, 30, 30, 30, 30.33, 30.16, 30.58, 31, 31,
31, 30.83, 29.16, 28.85, 28, 28, 28, 28]+273);
[augp8, enep220] = exppoly(220, 23.7, [05 31], [18
37], [28, 28, 28, 28, 28.65, 29, 29, 29.33, 30, 30, 30.41, 30.83, 31, 30.83,
29.16, 29.63, 31, 31, 30.68, 30.26]+273);
[augp9, enep221] = exppoly(221, 23.7, [05 31], [18
36], [28, 28, 28.41, 28.83, 29, 29.09, 29.99, 30.33, 31, 31, 31, 31, 31.66,
32, 32, 32, 32, 32, 32, 32]+273);
[augp10, enep222] = exppoly(222, 23.7, [05 32], [18
35], [28, 28, 28.41, 28.83, 29, 29.09, 29.99, 30.33, 31, 31, 30.81, 32, 32,
32, 31.7, 31.28, 31.55, 31.96, 32, 31.73]+273);
[augp11, enep223] = exppoly(223, 23.7, [05 32], [18
35], [27, 27, 27, 27, 26.31, 26.11, 26.91, 27.73, 29, 29, 29.45, 29.86, 30.
7, 30.88, 30.05, 30, 30, 30, 30, 30]+273);
[augp12, enep224] = exppoly(224, 23.7, [05 33], [18
34], [27.21, 27.61, 28, 28, 28.67, 29.11, 29.91, 30, 29.77, 29.53, 29.45,
29.86, 30.7, 30.88, 30.05, 30, 30, 30, 30, 30]+273);

```

```

[augp13, enep225] = exppoly(225, 23.7, [05 33], [18
33], [29, 29, 29, 29, 30.04, 30.09, 30.99, 32, 32.43, 32.86, 32.26, 33.69,
32.83, 33.05, 33.91, 33.79, 33.43, 33, 32.57, 32.14]+273);
[augp14, enep226] = exppoly(226, 23.7, [05 33], [18
32], [27, 27, 27, 27, 27.34, 28.09, 28.94, 29, 29, 29, 29.37, 29.91, 30.61,
30.94, 30.07, 30, 30, 30, 30, 30]+273);
[augp15, enep227] = exppoly(227, 23.7, [05 34], [18
32], [29, 29, 29, 29, 30.04, 30.09, 30.99, 32, 32.43, 32.86, 32.26, 33.69,
32.83, 33.05, 33.91, 33.79, 33.43, 33, 32.57, 32.14]+273);
[augp16, enep228] = exppoly(228, 23.7, [05 34], [18
32], [26, 26.31, 27, 27, 27, 27, 27, 27, 27.41, 27.64, 28.29, 28.91, 29, 29.
67, 30.91, 31, 31, 31, 31, 31]+273);
[augp17, enep229] = exppoly(229, 23.7, [05 35], [18
30], [28, 28, 28, 28, 28.29, 28.91, 29.45, 29.86, 31.2, 32.45, 32.26, 33.6
9, 32.83, 33.05, 33.91, 33.79, 33.43, 33, 32.57, 32.14]+273);
[augp18, enep230] = exppoly(230, 23.7, [05 35], [18
29], [29, 29, 29, 29, 30.04, 30.09, 30.99, 32, 32.43, 32.86, 32, 32, 32, 32,
32, 32, 31.77, 31.35, 30.77, 30.65]+273);
[augp19, enep231] = exppoly(231, 23.7, [05 35], [18
28], [29, 29, 29, 29, 30.04, 30.09, 30.99, 30, 30, 30, 30, 30, 30, 30, 30, 30.94,
31, 31, 31, 30.5, 30.32]+273);
[augp20, enep232] = exppoly(232, 23.7, [05 36], [18
27], [27, 27.43, 27.86, 27.43, 27, 27.43, 28, 28.86, 29.29, 28.86, 29.29,
31.01, 30.15, 30, 30, 30, 30, 30.43, 31, 31]+273);
[augp21, enep233] = exppoly(233, 23.7, [05 36], [18
27], [28, 28, 28.43, 28.86, 30.58, 31.44, 31, 31.86, 33, 33, 31.86, 31.43,
31.43, 31.86, 32.72, 33.15, 32.29, 31.86, 31, 31]+273);
[augp22, enep234] = exppoly(234, 23.7, [05 37], [18
26], [28, 28.21, 28.63, 28.84, 29.91, 30.77, 31.63, 32.06, 32.92, 31.57,
31, 31, 31, 30.77, 30.27, 30, 30, 30.43, 31, 31]+273);
[augp23, enep235] = exppoly(235, 23.7, [05 37], [18
25], [29, 29.43, 30, 30, 30, 30, 30.86, 31.29, 32.15, 32, 32, 32, 32.86, 32.
43, 32, 32, 31.57, 31.14, 31, 31]+273);
[augp24, enep236] = exppoly(236, 23.7, [05 37], [18
24], [29, 29.43, 30, 30, 30, 30, 30.86, 31.29, 32.15, 32, 32, 32, 32.86, 32.
43, 32, 32, 31.57, 31.14, 31, 31]+273);
[augp25, enep237] = exppoly(237, 23.7, [05 38], [18
23], [28, 28.21, 28.63, 28.84, 29.91, 30.77, 31.63, 32.06, 32.92, 31.57,
31, 31, 31, 30.77, 30.27, 30, 30, 30.43, 31, 31]+273);
[augp26, enep238] = exppoly(238, 23.7, [05 38], [18
22], [28.43, 28.86, 29.86, 30.72, 31.47, 32.33, 33, 33, 33.43, 31.57, 31,
31, 31, 30.77, 30.27, 30, 30, 30.43, 29.31, 29]+273);
[augp27, enep239] = exppoly(239, 23.7, [05 38], [18
21], [26, 26.55, 27.63, 27.88, 27.21, 26, 26, 26, 27, 27.31, 27.81, 27.43,
27, 27, 26.34, 26, 26, 26, 26, 26]+273);
[augp28, enep240] = exppoly(240, 23.7, [05 39], [18
20], [26, 26.55, 26, 26, 26, 26.88, 27.68, 28, 28, 28.6, 28.84, 28.63, 27.6
3, 27.07, 26.43, 27, 27, 27.77, 27.91, 28]+273);
[augp29, enep241] = exppoly(241, 23.7, [05 39], [18
19], [28, 28, 28.43, 28.86, 30.58, 31.44, 31, 31.86, 33, 33, 33, 33, 33, 33,
32.57, 32.14, 31.57, 31.14, 31, 31]+273);

```

```
[augp30, enep242] = exppoly(242, 23.7, [05 39], [18
18], [28, 28.21, 28.63, 28.84, 29.91, 30.77, 31.63, 32.06, 32.92, 31.57,
31, 31, 31, 30.77, 30.27, 30, 30, 30.43, 31, 31]+273);
[augp31, enep243] = exppoly(243, 23.7, [05 40], [18
17], [29, 29, 29.43, 29.86, 30.72, 31.15, 32.01, 32.44, 33.3, 33.73, 34, 3
4, 34.86, 35, 34.57, 34.14, 33.28, 31.77, 31.14, 31]+273);
```

```
energyp8=(enep214+enep215+enep216+enep217+enep218+enep219+enep
220+enep221+enep222+enep223+enep224+enep225+enep226+enep227+en
ep228+enep229+enep230+enep231+enep232+enep233+enep234+enep235+
enep236+enep237+enep238+enep239+enep240+enep241+enep242+enep24
3)/30;
totalp8=energyp8*31;
energyp8=[enep214, enep215, enep216, enep217, enep218, enep219, enep
220, enep221, enep222, enep223, enep224, enep225, enep226, enep227, en
ep228, enep229, enep230, enep231, enep232, enep233, enep234, enep235,
enep236, enep237, enep238, enep239, enep240, enep241, enep242, enep24
3];
augp=[2, 3, 4, 5, 6, 7, 8, 9, 10, 11, 12, 13, 14, 15, 16, 17, 18, 19, 20, 21, 22, 2
3, 24, 25, 26, 27, 28, 29, 30, 31];
```

⌘

```
[septp3, enep246] = exppoly(246, 23.7, [05 41], [18
14], [28, 28, 29.17, 29.95, 30, 30.08, 30.9, 31.17, 32, 32, 32, 32, 32, 32, 2
8.87, 29.17, 30, 30, 30, 30]+273);
[sseptp4, enep247] = exppoly(247, 23.7, [05 41], [18
13], [27, 27, 27.35, 27.88, 28, 28.1, 28.93, 29.77, 31.27, 31.6, 32.3, 32.
67, 33.69, 33.96, 34, 33.91, 32.87, 32.51, 32, 32]+273);
[sseptp5, enep248] = exppoly(248, 23.7, [05 41], [18
12], [27, 28.13, 28.07, 27.37, 27, 27.37, 28.93, 29.43, 32, 32, 32, 32, 32,
32, 32.77, 33, 33, 32.51, 31.77, 31.4]+273);
[sseptp9, enep252] = exppoly(252, 23.7, [05 43], [18
08], [27.21, 28.2, 29.43, 29.86, 30.72, 31.15, 31.91, 32, 31.66, 30.77, 2
9, 29, 30.88, 31.92, 29.56, 29, 28.87, 28.41, 28, 28]+273);
[sseptp10, enep253] = exppoly(253, 23.7, [05 43], [18
07], [26, 26.55, 27.63, 27.88, 27.21, 26, 26, 26, 27, 27.31, 27.81, 27.43,
27, 27, 26.34, 26, 26, 26, 26, 26]+273);
[sseptp11, enep254] = exppoly(254, 23.7, [05 43], [18
06], [27, 27, 27.35, 27.88, 28, 28.1, 28.93, 29.77, 31.27, 31.6, 32.3, 32.
67, 31.92, 30.88, 29.68, 29.27, 28.41, 28.06, 28.55, 28.93]+273);
[sseptp14, enep257] = exppoly(257, 23.7, [05 44], [18
03], [28, 28, 28.43, 28.86, 28.33, 28, 28, 28.43, 29, 29, 29, 29, 29, 29, 29.
86, 30.29, 31.15, 30.72, 29.86, 29.43]+273);
[sseptp15, enep258] = exppoly(258, 23.7, [05 45], [18
02], [27.35, 27.67, 30, 30, 30.67, 31, 31, 31.23, 32, 32, 32.17, 32.58, 32.
87, 32.25, 29.86, 30.29, 31, 31, 31.06, 31]+273);
```

```

[septp16, enep259] = exppoly(259, 23.7, [05 45], [18
01], [28, 28, 28, 28, 28.68, 29.17, 30.62, 31.23, 32.01, 32.24, 33.1, 33.3
4, 32.87, 31.98, 32.45, 32.81, 33, 33, 33, 33]+273);
[septp19, enep262] = exppoly(262, 23.7, [05 46], [17
58], [27, 27.43, 28.43, 28.86, 29.58, 30.01, 31.73, 32, 32.43, 32.86, 32.
86, 32.43, 32.1, 32.45, 32.11, 31.6, 32.61, 33, 33, 33]+273);
[septp20, enep263] = exppoly(263, 23.7, [05 46], [17
57], [29.05, 29.61, 30, 30, 30, 30.06, 30.97, 31, 31.15, 31.56, 32, 32, 32,
32.06, 32.9, 33, 32.86, 32.45, 32, 32]+273);
[septp23, enep266] = exppoly(266, 23.7, [05 47], [17
54], [28, 28, 28.43, 28.86, 29, 29, 29.86, 30, 30.43, 30.86, 31.72, 32, 32.
86, 33, 32.96, 32.53, 32, 32, 31.14, 31]+273);
[septp24, enep267] = exppoly(267, 23.7, [05 48], [17
53], [28, 28, 28.43, 28.86, 30.58, 31.44, 31, 31.86, 33, 33, 33, 33, 33, 33,
32.57, 32.14, 31.57, 31.14, 31, 31]+273);
[septp25, enep268] = exppoly(268, 23.7, [05 48], [17
52], [27, 27.43, 28, 28, 28.86, 29, 29, 29.43, 30.72, 31.58, 32, 32, 31.77,
31.57, 31.04, 31.47, 31.93, 31.96, 31.2, 30.77]+273);
[septp28, enep271] = exppoly(271, 23.7, [05 49], [17
50], [26.55, 26.06, 26, 26, 26.88, 27.1, 28, 28, 28.6, 28.94, 28.63, 27.88
, 27.07, 26.55, 27, 27, 27.77, 27.88, 28, 28]+273);
[septp29, enep272] = exppoly(272, 23.7, [05 49], [17
48], [27.65, 28.88, 29, 29, 29, 29, 29, 29, 29, 29, 29, 29, 29, 29, 29, 29.33, 29.
95, 30, 29.87, 28.23, 27.88]+273);
[septp30, enep273] = exppoly(273, 23.7, [05 50], [17
47], [26.45, 26.88, 27, 27, 27, 27, 27, 27, 27.15, 27.77, 29.15, 29.52, 30,
30, 29.56, 29.14, 29, 28.95, 28.21, 28]+273);

```

```

energyp9=(enep246+enep247+enep248+enep252+enep253+enep254+enep
257+enep258+enep259+enep262+enep263+enep266+enep267+enep268+en
ep271+enep272+enep273)/17;
totalp9=energyp9*30;
energyp9=[enep246, enep247, enep248, enep252, enep253, enep254, enep
257, enep258, enep259, enep262, enep263, enep266, enep267, enep268, en
ep271, enep272, enep273];
septp=[3, 4, 5, 9, 10, 11, 14, 15, 16, 19, 20, 23, 24, 25, 28, 29, 30];

```

⌘

```

[octp2, enep275] = exppoly(275, 23.7, [05 50], [17
45], [28, 28, 28.65, 29.03, 29.8, 30.18, 30.95, 31, 31.3, 32.45, 34, 34, 34
.4, 34.78, 34.45, 34.07, 34, 33.92, 33.15, 32.53]+273);
[octp3, enep276] = exppoly(276, 23.7, [05 51], [17
41], [27, 27, 27.67, 28.05, 28.82, 29, 29, 29.35, 30.12, 30.5, 31.53, 32.3
, 32.17, 29.4, 29.3, 28.15, 28.72, 29.1, 29.87, 30]+273);
[octp4, enep277] = exppoly(277, 23.7, [05 51], [17
43], [26, 26, 26.67, 27, 27, 27, 27, 27, 27, 27, 27, 27, 27, 27, 27, 27, 27,
27, 27]+273);

```

```

[octp5, enep278] = exppoly(278, 23.7, [05 52], [17
42], [25, 25, 25.68, 26, 26, 26, 26, 26.37, 27, 27, 27.28, 27.67, 28.43, 28.
82, 29, 29, 29, 29, 29, 29]+273);
[octp6, enep279] = exppoly(279, 23.7, [05 52], [17
41], [27, 27, 27, 27, 27, 27, 27, 27.37, 28, 28, 28.28, 28.67, 29, 29, 27.83,
27.07, 27.73, 27.88, 27.12, 27]+273);
[octp7, enep280] = exppoly(280, 23.7, [05 52], [17
40], [25, 25, 25.68, 26, 26, 26.22, 26.98, 27.37, 28.13, 28.52, 29.28, 29.
67, 30.43, 30.82, 30.42, 30.03, 30, 30, 30, 29.47]+273);
[octp8, enep281] = exppoly(281, 23.7, [05 53], [17
39], [27, 27, 27.7, 28.08, 28.85, 29.23, 30, 30.38, 31, 31, 31.3, 31.68, 32
, 32, 32, 32, 30.5, 29.65, 27.3, 27]+273);
[octp9, enep282] = exppoly(282, 23.7, [05 53], [17
38], [26.55, 26.93, 27.7, 28, 28, 28.23, 29, 29.38, 30.15, 30.53, 31.3, 31
.58, 32, 32, 32, 32, 30.25, 30.87, 30.1, 30]+273);
[octp10, enep283] = exppoly(283, 23.7, [05 53], [17
37], [26.55, 26.93, 27.7, 28.08, 28.85, 29.23, 30, 30.22, 31.15, 31.53, 3
2.3, 32.68, 33, 33, 32.4, 32.02, 32.75, 32.87, 32.1, 32]+273);
[octp11, enep284] = exppoly(284, 23.7, [05 54], [17
36], [27, 27, 27.67, 28.07, 29.53, 30.27, 31.73, 32.23, 32.97, 33.33, 33.
93, 33.57, 33, 33, 33, 33, 33, 33, 32.53, 32.17]+273);
[octp12, enep285] = exppoly(285, 23.7, [05 54], [17
35], [27.57, 27.93, 28.67, 29.03, 29.77, 30.13, 30.87, 31.23, 31.97, 32.
33, 33, 33, 33, 33, 33.27, 32.63, 33.63, 33.27, 32.53, 32.17]+273);
[octp13, enep286] = exppoly(286, 23.7, [05 55], [17
34], [27.58, 27.95, 28, 28, 28, 28, 28, 28.25, 28.98, 29.35, 30.08, 30.45,
31.18, 31.55, 32, 32, 32, 32, 31.03, 30.3]+273);
[octp14, enep287] = exppoly(287, 23.7, [05 55], [17
33], [27.58, 27.95, 28, 28.1, 29.57, 30.15, 30.88, 31, 31, 31.35, 32, 32, 3
2, 32, 32, 32, 32, 31.52, 31.15]+273);
[octp15, enep288] = exppoly(288, 23.7, [05 56], [17
32], [26.6, 26.97, 28.4, 29.07, 29.8, 30.17, 30.9, 31.27, 32, 32.37, 32.9
, 32.53, 32, 32, 31.7, 31.33, 30.6, 30.23, 28.5, 27.4]+273);
[octp16, enep289] = exppoly(289, 23.7, [05 56], [17
32], [26, 26, 26.7, 27.07, 27.8, 28.17, 28.9, 29.27, 30, 30, 30, 30, 30, 30,
30, 30, 30, 30, 29, 28.27]+273);
[octp17, enep290] = exppoly(290, 23.7, [05 56], [17
31], [26.6, 26.97, 27.7, 28.07, 28.8, 29.17, 29.9, 30.27, 31, 31, 31.1, 31
.47, 32, 32, 31.7, 31.33, 30.6, 30.23, 30, 30]+273);
[octp18, enep291] = exppoly(291, 23.7, [05 57], [17
30], [27, 27, 27.72, 28.08, 28.82, 29.37, 30.83, 31.28, 32, 32, 32, 32, 32,
32, 32, 32, 31.58, 31.22, 31, 31]+273);
[octp19, enep292] = exppoly(292, 23.7, [05 57], [17
29], [26.62, 26.98, 27.72, 28.17, 29.63, 30, 30, 30.28, 31, 31, 31.12, 31.
48, 32, 32, 32.32, 32.68, 33, 33, 31.97, 31.23]+273);
[octp20, enep293] = exppoly(293, 23.7, [05 58], [17
28], [26, 26, 26.9, 27.1, 27.83, 28.2, 28.93, 29.3, 30.03, 30.4, 30.73, 29
, 29.23, 29.6, 29.67, 29.3, 29, 29, 29, 29]+273);
[octp21, enep294] = exppoly(294, 23.7, [05 58], [17
27], [26, 26, 26, 26.2, 27.67, 28.2, 28.93, 29, 29, 29, 29, 29, 29, 29, 29,
29, 29, 28.57, 28.2, 27.47, 27.1]+273);

```

```

[octp22, enep295] = exppoly(295, 23.7, [05 59], [17
27], [26.65, 27, 27, 27.12, 27.85, 28.22, 28.95, 29, 29, 29, 29.15, 29.52,
30, 30, 29, 27.85, 26.55, 26.18, 25.45, 25.08]+273);
[octp23, enep296] = exppoly(296, 23.7, [05 59], [17
26], [25, 25.02, 25.75, 26, 26, 26.22, 26.95, 27, 27.05, 27.42, 28, 28, 28,
28, 28, 28, 27.55, 27.18, 27, 27]+273);
[octp25, enep298] = exppoly(298, 23.7, [06 00], [17
24], [26.33, 26.03, 26.77, 27, 27, 27, 27, 27, 27, 27, 27, 27, 27, 27, 27, 26.65,
26.27, 26, 26, 26, 26]+273);
[octp26, enep299] = exppoly(299, 23.7, [06 01], [17
24], [24.68, 25, 25, 25.15, 25.88, 26, 26, 26, 26, 26, 26, 26, 26, 26, 26, 26,
25.52, 25.15, 25, 25]+273);
[octp27, enep300] = exppoly(300, 23.7, [06 01], [17
23], [25, 25, 25, 25, 25, 25.25, 25.98, 26.7, 27.83, 27.55, 27, 27, 27, 27, 27,
7.73, 28.5, 29, 29, 28.42, 28.05]+273);
[octp28, enep301] = exppoly(301, 23.7, [06 02], [17
22], [24.3, 24.07, 24.8, 25.17, 25.9, 26.27, 27, 27.37, 28, 28, 28.2, 28.5
7, 29.6, 30.33, 31, 31, 30.5, 30.13, 26.4, 29.03]+273);
[octp29, enep302] = exppoly(302, 23.7, [06 02], [17
21], [24.3, 24.07, 24.8, 25.33, 26.8, 27.27, 28, 28.37, 29.1, 29.47, 30.2
, 30.57, 31, 31, 31, 31, 30.5, 30.13, 29.4, 29.03]+273);
[octp30, enep303] = exppoly(303, 23.7, [06 03], [17
21], [24, 24.08, 24.82, 25.18, 25.92, 26.28, 27.02, 27.38, 28.17, 28.97,
30, 30, 30.32, 30.68, 30.6, 30.22, 29.48, 29.12, 29, 29]+273);
[octp31, enep304] = exppoly(304, 23.7, [06 04], [17
20], [23.23, 24, 24, 24.4, 25.87, 26.6, 28.03, 28.4, 29.13, 29.5, 30.23, 3
0.6, 31.33, 31.7, 32, 32, 31.47, 31.1, 30.37, 30]+273);

```

```

energyp10=(enep275+enep276+enep277+enep278+enep279+enep280+ene
p281+enep282+enep283+enep284+enep285+enep286+enep287+enep288+e
nep289+enep290+enep291+enep292+enep293+enep294+enep295+enep296
+enep298+enep299+enep300+enep301+enep302+enep303+enep304)/29;
totalp10=energyp10*31;
energyp10=[enep275, enep276, enep277, enep278, enep279, enep280, ene
p281, enep282, enep283, enep284, enep285, enep286, enep287, enep288, e
nep289, enep290, enep291, enep292, enep293, enep294, enep295, enep296
, enep298, enep299, enep300, enep301, enep302, enep303, enep304];
octp=[2, 3, 4, 5, 6, 7, 8, 9, 10, 11, 12, 13, 14, 15, 16, 17, 18, 19, 20, 21, 22, 2
3, 25, 26, 27, 28, 29, 30, 31];

```

⌘

```

[novp1, enep305] = exppoly(305, 23.7, [06 04], [17
19], [24, 24.08, 24.78, 25.27, 26.67, 27.18, 27.88, 28, 28, 28.28, 28.98,
29.33, 30.03, 30.38, 31, 31, 30.87, 30.52, 29.82, 29.47]+273);
[novp2, enep306] = exppoly(306, 23.7, [06 05], [17
19], [24, 24.1, 24.8, 25.15, 25.85, 26.2, 26.9, 27.25, 27.95, 28.3, 29, 29
.7, 31, 31, 30.9, 30.55, 30, 30, 26.4, 28.4]+273);
[novp3, enep307] = exppoly(307, 23.7, [06 05], [17
18], [24, 24.1, 24.8, 25.3, 26.7, 27.2, 27.9, 28, 28, 28.3, 29, 29.35, 30, 3
0, 29.9, 29.55, 29.85, 29.5, 27.8, 27.45]+273);

```



```

[novp4, enep308] = exppoly(308, 23.7, [06 06], [17
18], [24, 24, 24, 24.17, 24.87, 25.43, 26.83, 27.27, 27.97, 27.32, 29.02,
29.37, 30, 30, 29.88, 29.53, 29, 28.48, 27.78, 27.43]+273);
[novp5, enep309] = exppoly(309, 23.7, [06 06], [17
17], [24, 24.12, 24.82, 25.17, 25.87, 26.22, 26.92, 27.27, 27.97, 28.32,
28.98, 28.63, 28, 28, 28, 28, 28, 28, 28]+273);
[novp6, enep310] = exppoly(310, 23.7, [06 07], [17
17], [23, 23.13, 23.83, 24.18, 24.88, 25.23, 25.93, 26, 26, 26.33, 27.03,
27.38, 28, 28, 28.13, 28.48, 29, 29, 28.75, 28.42]+273);
[novp7, enep311] = exppoly(311, 23.7, [06 08], [17
16], [23, 23.15, 23.85, 24.2, 24.9, 25.25, 25.95, 26, 26, 26.35, 27.05, 24
.4, 28.1, 28.45, 29, 29, 29, 29, 29, 29]+273);
[novp8, enep312] = exppoly(312, 23.7, [06 08], [17
16], [23, 23.15, 23.85, 25.15, 25.85, 26.5, 27.9, 28.5, 30, 30, 30, 30, 30,
30, 30, 30, 29.85, 29.45, 28.75, 28.4]+273);
[novp9, enep313] = exppoly(313, 23.7, [06 09], [17
15], [20.37, 20.33, 21.73, 22.43, 23.83, 24.53, 25.93, 26.63, 28.03, 28.
73, 30, 30, 30.12, 30.47, 30.83, 30.48, 30, 30, 29.47, 28.77]+273);
[novp10, enep314] = exppoly(314, 23.7, [06 10], [17
15], [23.83, 24, 24, 24.47, 25.87, 26.57, 27.97, 28.33, 29, 29, 29.08, 29.
43, 30.13, 30.48, 30.82, 30.47, 29.93, 29.42, 28.72, 28.37]+273);
[novp11, enep315] = exppoly(315, 23.7, [06 10], [17
14], [22, 22.18, 22.88, 23.23, 24.93, 28.13, 26.93, 27.67, 29.03, 29.38,
30, 30, 30, 30, 30, 30, 29.94, 29.42, 28.73, 28.37]+273);
[novp12, enep316] = exppoly(316, 23.7, [06 11], [17
14], [21.37, 21.53, 22.25, 22.6, 23.6, 24.3, 25.37, 26.4, 26.47, 27.17, 2
8.45, 28.8, 29.5, 29.85, 30, 30, 28.8, 28.1, 28.45, 28]+273);
[novp13, enep317] = exppoly(317, 23.7, [06 11], [17
14], [20, 20.2, 20.9, 21.75, 23.85, 24.3, 25, 25.7, 27.05, 24.4, 28.1, 28.
45, 29, 29, 29, 29, 28.72, 28.4, 27.7, 27.45]+273);
[novp14, enep318] = exppoly(318, 23.7, [06 12], [17
13], [18.27, 18.43, 19.83, 21.07, 23.87, 24.63, 26.02, 26.37, 27.13, 27.
83, 29, 29, 29, 29, 29.22, 29.57, 29.7, 29.38, 29, 29]+273);
[novp15, enep319] = exppoly(319, 23.7, [06 13], [17
13], [20, 20.23, 20.93, 21.85, 23.95, 24.67, 26.07, 26.77, 28.17, 28.87,
30, 30, 30, 30, 30.23, 30.57, 31.32, 31.63, 29.72, 29.32]+273);
[novp16, enep320] = exppoly(320, 23.7, [06 13], [17
13], [22, 22.47, 23.87, 24.28, 24.98, 25.33, 26.03, 26.38, 27.08, 27.43,
28.13, 28.48, 30, 30, 30.23, 30.58, 30.68, 30.37, 29.43, 28.63]+273);
[novp17, enep321] = exppoly(321, 23.7, [06 14], [17
12], [20.9, 21.25, 21.95, 22.3, 23, 23.35, 24.02, 24.4, 25.1, 25.45, 26.3
, 27, 28.4, 29.07, 29.5, 28.8, 27.67, 27.45, 26.4, 26.6]+273);
[novp18, enep322] = exppoly(322, 23.7, [06 15], [17
12], [19.08, 19.53, 20.93, 21.95, 23.02, 23.37, 25.03, 25.42, 26.23, 26.
93, 28.67, 29.03, 30, 30, 30, 30, 29.5, 29.33, 28.68, 28.28]+273);
[novp19, enep323] = exppoly(323, 23.7, [06 15], [17
12], [19.17, 19.53, 20.93, 21.95, 24.03, 24.73, 26.03, 26.42, 27.23, 27.
93, 29.17, 29.52, 30.22, 30.57, 30.47, 29.77, 29, 29, 28.68, 28.28]+273)
;

```

```

[novp20, enep324] = exppoly(324, 23.7, [06 16], [17
12], [20, 20.28, 20.98, 21.67, 23.07, 23.77, 25.1, 25.87, 27.27, 27.97, 2
9, 29.23, 29.58, 29.43, 28.73, 28, 28, 27.33, 26.53]+273);
[novp21, enep325] = exppoly(325, 23.7, [06 17], [17
11], [20, 20.6, 22, 22.7, 25.05, 25.4, 26.07, 26.45, 27.15, 27.5, 28, 28, 2
8, 28, 28.3, 28.65, 28.75, 28.3, 28, 28]+273);
[novp22, enep326] = exppoly(326, 23.7, [06 18], [17
11], [19, 19.95, 22.02, 22.37, 23.07, 23.42, 24.17, 24.93, 26.33, 27.03,
28, 28, 28, 28, 28.32, 28.67, 28.63, 28.28, 27.63, 27.23]+273);
[novp23, enep327] = exppoly(327, 23.7, [06 18], [17
11], [19.97, 20.32, 21.05, 22.1, 24.13, 24.83, 26.08, 26.47, 27.17, 27.5
2, 28.22, 28.57, 29.27, 29.62, 30, 30, 29.63, 29.28, 28.63, 28.23]+273);
[novp24, enep328] = exppoly(328, 23.7, [06 19], [17
11], [19, 19.33, 20.1, 21.15, 23.17, 23.87, 25.1, 25.48, 26.18, 26.53, 27
.23, 27.58, 28, 28, 28, 28, 27.662, 27.27, 26.62, 26.22]+273);
[novp25, enep329] = exppoly(329, 23.7, [06 20], [17
11], [20, 20.18, 21.15, 22.2, 24.2, 24.9, 26.23, 27, 28.2, 28.55, 29.25, 2
9.6, 29.7, 29.45, 29, 29, 28.2, 27.5, 26.2, 25.4]+273);
[novp26, enep330] = exppoly(330, 23.7, [06 20], [17
11], [20, 20.7, 22.1, 22.8, 24.2, 24.9, 26.23, 27, 28, 28, 28.25, 28.6, 29.
3, 29.65, 29.75, 29.3, 28.6, 28.35, 27.6, 27.2]+273);
[novp27, enep331] = exppoly(331, 23.7, [06 21], [17
11], [21.02, 21.37, 22.07, 22.42, 23.12, 23.47, 24.27, 25.03, 26.22, 26.
57, 27.27, 27.61, 28.32, 28.67, 28.63, 28.28, 27.17, 26.47, 25.58, 25.18
]+273);
[novp30, enep334] = exppoly(334, 23.7, [06 23], [17
11], [20.05, 25.4, 21.3, 22.35, 24.15, 24.5, 25.33, 26.1, 27.25, 27.6, 28
.3, 28.65, 29, 29, 29, 29, 28.1, 27.4, 26.55, 26.15]+273);

```

```

energyp11=(enep305+enep306+enep307+enep308+enep309+enep310+ene
p311+enep312+enep313+enep314+enep315+enep316+enep317+enep318+e
nep319+enep320+enep321+enep322+enep323+enep324+enep325+enep326
+enep327+enep328+enep329+enep330+enep331+enep334)/28;
totalp11=energyp11*30;
energyp11=[enep305, enep306, enep307, enep308, enep309, enep310, ene
p311, enep312, enep313, enep314, enep315, enep316, enep317, enep31, en
ep319, enep320, enep321, enep322, enep323, enep324, enep325, enep326,
enep327, enep328, enep329, enep330, enep331, enep334];
novp=[1, 2, 3, 4, 5, 6, 7, 8, 9, 10, 11, 12, 13, 14, 15, 16, 17, 18, 19, 20, 21, 22
, 23, 24, 25, 26, 27, 30];

```

⌘

```

[decp1, enep335] = exppoly(335, 23.7, [06 24], [17
11], [20.07, 20.4, 21.13, 21.8, 23.13, 23.8, 25.07, 25.4, 26.13, 26.8, 11
.07, 11.4, 29.07, 29.4, 30, 30, 30, 29.93, 28.87, 28.2]+273);
[decp2, enep336] = exppoly(336, 23.7, [06 24], [17
11], [20.07, 20.4, 21.07, 21.4, 22.2, 23.2, 25.07, 25.4, 26.07, 26.4, 27.
07, 27.4, 28.07, 28.4, 29, 29, 28.93, 28.6, 27.87, 27.2]+273);

```

```

[dec3, enep337] = exppoly(337, 23.7, [06 25], [17
11], [20.17, 20.83, 22.17, 22.83, 24.08, 24.42, 25.17, 25.83, 27.25, 28.
25, 30, 30, 30, 30, 29.92, 29.58, 29, 29, 28.83, 28.17]+273);
[dec4, enep338] = exppoly(338, 23.7, [06 26], [17
11], [20.2, 20.87, 22.2, 22.87, 24.2, 24.87, 26.1, 26.43, 27.1, 27.43, 28
.1, 28.43, 29, 29, 29.1, 29.43, 29.8, 29.13, 27.9, 27.67]+273);
[dec6, enep340] = exppoly(340, 23.7, [06 27], [17
11], [20.23, 20.9, 22.12, 22.45, 23.23, 23.9, 25.23, 25.9, 27.12, 27.45,
28.12, 28.45, 29, 29, 29, 29, 28.77, 28.1, 27, 27]+273);
[dec7, enep341] = exppoly(341, 23.7, [06 28], [17
12], [20.27, 20.93, 22.13, 22.47, 23.27, 23.93, 25.13, 25.47, 26.13, 26.
47, 27.13, 27.47, 28, 28, 27.87, 27.63, 26.87, 26.63, 25.87, 25.63]+273)
;
[dec8, enep342] = exppoly(342, 23.7, [06 28], [17
12], [20, 20, 20.23, 20.9, 22.23, 22.9, 24.23, 24.9, 26.13, 26.47, 27.23,
27.9, 29, 29, 29, 29, 29, 28.87, 28.63, 27.87, 27.53]+273);
[dec9, enep343] = exppoly(343, 23.7, [06 29], [17
12], [18.3, 18.97, 20.3, 20.97, 24, 24, 24, 24, 24.3, 24.97, 26.15, 26.48,
27, 27, 27.15, 27.48, 28.15, 28.48, 26.85, 26.62]+273);
[dec10, enep344] = exppoly(344, 23.7, [06 30], [17
12], [20.17, 20.5, 21.33, 22, 23.33, 24, 25.17, 25.5, 26.33, 27, 28.17, 28
.5, 29, 29, 28.83, 28.5, 27.83, 27.5, 26.83, 26.5]+273);
[dec11, enep345] = exppoly(345, 23.7, [06 30], [17
13], [21.17, 21.5, 22.17, 22.5, 23.33, 24, 25.17, 25.5, 26.17, 26.5, 27, 2
7, 27.17, 27.5, 28, 28, 27.83, 27.5, 26.83, 26.5]+273);
[dec12, enep346] = exppoly(346, 23.7, [06 31], [17
13], [18.18, 18.52, 19.37, 20.03, 21.37, 22.03, 23.18, 23.52, 24.18, 24.
52, 25, 25, 25.18, 25.52, 26, 26, 25.88, 25.47, 25, 25]+273);
[dec13, enep347] = exppoly(347, 23.7, [06 32], [17
13], [16.2, 16.53, 17.6, 18.6, 20.2, 20.53, 23.2, 23.53, 24.4, 25.07, 26,
26, 26.2, 26.53, 27, 27, 26.8, 26.47, 25.6, 24.93]+273);
[dec14, enep348] = exppoly(348, 23.7, [06 32], [17
14], [17.8, 17.43, 17.6, 18.6, 20.4, 21.07, 22.4, 23.07, 24.4, 25.07, 26.
2, 26.53, 27, 27, 26.8, 26.47, 25.8, 25.47, 24.8, 24.47]+273);
[dec15, enep349] = exppoly(349, 23.7, [06 33], [17
14], [16, 16, 16.65, 17.65, 19.43, 20.1, 21.43, 22.1, 23.43, 24.1, 25.43,
26.1, 27, 27, 26.78, 26.45, 25.78, 25.45, 23.78, 23.45]+273);
[dec16, enep350] = exppoly(350, 23.7, [06 33], [17
14], [16.22, 16.55, 17.22, 17.55, 18.87, 20.2, 22.43, 23.1, 24.22, 24.55
, 25.22, 25.55, 26.22, 26.55, 27, 27, 26.88, 26.45, 25.57, 24.9]+273);
[dec17, enep351] = exppoly(351, 23.7, [06 34], [17
15], [17.47, 18.13, 19.23, 19.57, 20.23, 20.57, 21.23, 21.57, 22.23, 22.
57, 23.47, 24.13, 25.23, 25.57, 25.77, 25.43, 24.77, 24.43, 25, 25]+273)
;
[dec18, enep352] = exppoly(352, 23.7, [06 35], [17
15], [15.25, 15.42, 17, 18.33, 20.5, 21.17, 22.25, 22.58, 23.5, 24.17, 25
, 25, 25.25, 25.58, 25.75, 25.42, 25, 25, 24.75, 24.42]+273);
[dec19, enep353] = exppoly(353, 23.7, [06 35], [17
16], [16.25, 16.42, 17.5, 18.17, 19.5, 20.17, 21.25, 21.42, 22.5, 23.17,
24, 24, 24.25, 24.42, 24.75, 24.48, 24.25, 24.42, 24.5, 23.83]+273);

```

```

[dec20, enep354] = exppoly(354, 23.7, [06 36], [17
16], [15.27, 15.6, 16.53, 17.2, 18.53, 19.2, 20.53, 21.2, 22.53, 23.2, 24
.27, 24.6, 25, 25, 24.73, 24.4, 23.73, 23.4, 23, 23]+273);
[dec21, enep355] = exppoly(355, 23.7, [06 36], [17
17], [19, 19, 19, 19, 19, 19, 19.27, 19.6, 20.27, 20.6, 21.53, 22.2, 23, 23,
23.27, 23.6, 24, 24, 23.73, 23.4]+273);
[dec22, enep356] = exppoly(356, 23.7, [06 37], [17
17], [18, 18, 18.28, 18.62, 19.28, 19.62, 20.28, 20.62, 21.28, 21.62, 22.
28, 22.62, 23, 23, 23, 23, 22.82, 22.48, 21.82, 21.48]+273);
[dec23, enep357] = exppoly(357, 23.7, [06 37], [17
18], [19.28, 19.62, 20, 20, 20.57, 21.23, 22.57, 23.23, 24.28, 24.62, 25,
25, 25.28, 25.62, 26, 26, 25.43, 24.77, 23.82, 23.48]+273);
[dec24, enep358] = exppoly(358, 23.7, [06 38], [17
18], [17.7, 17.37, 17.6, 18.27, 19.6, 20.27, 21.6, 22.27, 23.6, 24.27, 25
.6, 26.27, 27, 27, 27, 27, 26.7, 26.67, 25.7, 25.67]+273);
[dec25, enep359] = exppoly(359, 23.7, [06 38], [17
18], [17.3, 17.63, 18, 18, 18.3, 18.63, 19.3, 19.63, 20.3, 20.63, 21.6, 22
.27, 23, 23, 23, 23, 22.4, 21.73, 20.7, 20.37]+273);
[dec26, enep360] = exppoly(360, 23.7, [06 38], [17
19], [15.3, 15.63, 16, 16, 16.3, 16.63, 17.3, 17.63, 18.6, 19.27, 20.3, 20
.63, 21, 21, 21.3, 21.63, 22, 22, 22, 22]+273);
[dec27, enep361] = exppoly(361, 23.7, [06 39], [17
20], [14, 14, 14, 14, 14.32, 14.65, 15.32, 15.65, 16.32, 16.65, 17.32, 17.
65, 18.32, 18.65, 19.32, 19.65, 18.68, 19.45, 19, 19]+273);
[dec28, enep362] = exppoly(362, 23.7, [06 39], [17
20], [15, 15, 15.32, 15.65, 16.63, 17.3, 18.32, 18.65, 19.32, 19.65, 20.3
2, 20.65, 21.63, 22.3, 23, 23, 22.78, 22.45, 19.47, 20.7]+273);
[dec29, enep363] = exppoly(363, 23.7, [06 40], [17
21], [14.33, 14.67, 15.67, 16.33, 17, 17, 17.33, 17.67, 18.33, 18.67, 19.
67, 20.33, 21.33, 21.67, 22.67, 23.33, 23.77, 23.37, 22.77, 22.37]+273)
;
[dec30, enep364] = exppoly(364, 23.7, [06 40], [17
22], [14, 14, 14.67, 15.33, 16.67, 17.33, 18.67, 19.33, 21, 22, 23.33, 23.
67, 24.33, 24.67, 24.77, 24.33, 24, 24, 23.33, 22.67]+273);
[dec31, enep365] = exppoly(365, 23.7, [06 40], [17
22], [13.67, 14.33, 15, 15, 15.33, 15.67, 16.67, 16.33, 18.33, 18.67, 19.
67, 20.33, 21.33, 21.67, 21.33, 21.33, 21.33, 21.33, 21.33, 21.77, 21.43]+273)
;

```

```

energyp12=(enep335+enep336+enep337+enep338+enep340+enep341+ene
p342+enep343+enep344+enep345+enep346+enep347+enep348+enep349+e
nep350+enep351+enep352+enep353+enep354+enep355+enep356+enep357
+enep358+enep359+enep360+enep361+enep362+enep363+enep364+enep3
65)/30;
totalp12=energyp12*31;
energyp12=[enep335, enep336, enep337, enep338, enep340, enep341, ene
p342, enep343, enep344, enep345, enep346, enep347, enep348, enep349, e
nep350, enep351, enep352, enep353, enep354, enep355, enep356, enep357
, enep358, enep359, enep360, enep361, enep362, enep363, enep364, enep3
65];

```

```
decp=[1,2,3,4,6,7,8,9,10,11,12,13,14,15,16,17,18,19,20,21,22,23,24,25,26,27,28,29,30,31];
```

```
Month=[1,2,3,4,5,6,7,8,9,10,11,12];
```

```
totalpeneryp=[ totalp1,  
totalp2,totalp3,totalp4,totalp5,totalp6,totalp7,totalp8,totalp9,  
totalp10,totalp11,totalp12];
```

```
overyearp=sum(totalpeneryp)
```

```
%%%Tempdata
```

```
%%%Tempdata
```

```
JanTavg=[18.7330,21.5105,22.2010,21.0317,20.0177,18.2480,14.6190,  
12.8613,13.4453,21.5417,23.7500,22.0033,22.4273,18.4820,18.6323,  
20.4867,22.4340];
```

```
FebTavg=[21.007,22.836,24.515,24.333,25.962,26.00467,27.3133,26.9933,  
28.09867,28.32633,27.57767];
```

```
MarTavg=[26.796,27.6415,29.21733,28.7775,28.78567,27.71,28.46233,  
29.238,31.26,30.38067,29.459,28.758,30.151,29.822,29.52167,  
30.697,32.231,32.725,31.96357,30.49167,31.78167,30.5331];
```

```
AprTavg=[31.126,33.405,31.883,31.435,32.57367,33.07,32.46967,31.3933,  
33.813,33.56133,32.3233,31.551,28.33667,24.74557,29.35267,  
30.65733,29.1703,29.78733,25.961,29.695,30.7271,32.137,32.51,  
29.80633,29.089,31.607,31.651];
```

```
MayTavg=[33.40967,33.96433,31.17867,26.193,23.75167,27.36,30.17733,  
28.07,31.50167,31.973,28.506,25.66362,24.41533,29.61833,29.77167,  
32.10467,28.62833,28.63,26.68967,25.821,26.48233,29.84433,  
30.3133,30.52633,40.098,29.64,28.617,26.91133];
```

```
JuneTavg=[30.74552,31.66448,33.12828,31.44172,31.53276,30.64966,  
27.45379,31.47276,31.40793,31.25483,33.26552,32.46724,32.16793,  
29.92793,31.94483,32.16828,32.47724,33.95414,30.86241,30.78241,  
33.65983,31.25966,33.01828,32.09448,28.82517,29.68207,29.58172,  
28.23172,27.32207,29.30034];
```

```
JulyTavg=[30.111,31.143,30.621,29.29,31.472,31.095,31.381,32.116,  
31.391,31.172,31.334,29.893,29.167,30.301,31.136,30.716,31.187,  
30.418,30.071,29.974,32.426,30.075,32.830,32.298,31.,29.073,  
28.175,28.033,29.473,30.107,29.076];
```

```
AugTavg=[31.778,31.404,31.319,31.761,27.176,29.352,29.685,30.627,  
30.609,28.456,28.481,31.778,29.08,30.778,20.723,31.191,31.024,  
30.11,29.218,31.171,30.488,31.159,31.158,30.489,30.703,26.634,  
27.335,31.315,30.488,32.226];
```

```
SepTavg=[30.353,30.923,30.548,29.778,26.656,29.437,29.074,31.005,  
31.33,31.310,31.384,30.717,31.334,30.293,27.313,28.981,28.133];
```

```
OctTavg=[31.989,29.456,26.894,27.378,27.605,28.302,29.785,29.910,  
30.864,31.57,31.54,29.785,30.766,30.349,28.887,30.486,30.605,  
30.716,28.729,28.077,27.908,26.993,26.638,25.626,26.891,27.906,  
28.642,28.081,28.805];
```

```
NovTavg=[28.359,27.97,27.877,27.346,27.181,26.62,26.585,28.096,  
27.262,28.064,27.482,26.635,26.065,26.448,27.040,27.405,25.50
```

```

0,26.399,26.742,26.144,26.364,27.789,26.694,25.673,26.391,26.6
79,25.514,26.480];
DecTavg=[24.741,25.743,25.743,26.61,26.115,28.443,25.717,24.89
,25.929,25.647,23.563,23.525,23.524,22.852,23.247,22.697,27.71
9,22.087,21.677,21.338,21.099,23.353,33.396,20.49,19.243,16.89
5,19.468,19.542,20.737,21.733];
JanT=sum(JanTavg)/17;
FebT=sum(FebTavg)/11;
MarT=sum(MarTavg)/22;
AprT=sum(AprTavg)/27;
MayT=sum(MayTavg)/28;
JuneT=sum(JuneTavg)/30;
JulyT=sum(JulyTavg)/31;
AugT=sum(AugTavg)/30;
SepT=sum(SepTavg)/17;
OctT=sum(OctTavg)/29;
NovT=sum(NovTavg)/28;
DecT=sum(DecTavg)/31;

```

```

Temperature=[JanT, FebT, MarT, AprT, MayT, JuneT, JulyT, AugT, SepT, Oc
tT, NovT, DecT];
Intensity=[549.7279,564.8544,574.6825,591.6366,580.2789,576.37
96,583.8717,591.4996,585.0832,541.3622,530.8690,534.7277];

```

```

%%%%%%%%%plotting start

```

```

%%%%%%%%%plotting start

```

```

figure()
subplot(331)
hold on
plot(janp,energyp1,Jan,Energy1,Jan,JanTavg,'Linewidth',3),titl
e('energy in january'),xlabel('january'), ylabel('energy
/Whr')
hold off

```

```

%figure()
subplot(332)
hold on
plot(febp,energyp2,Feb,Energy2,Feb,FebTavg,'Linewidth',3),titl
e('energy in february'),xlabel('february'),
ylabel('energy/Whr')
hold off

```

```

%figure()
subplot(333)
hold on
plot(marp,energyp3,Mar,Energy3,Mar,MarTavg,'Linewidth',3),titl
e('energy in march'),xlabel('march'), ylabel('energy/Whr')
hold off

```

```
%figure()
subplot(334)
hold on
plot(aprp,energyp4,Apr,Energy4,Apr,AprTavg,'Linewidth',3),title('energy in april'),xlabel('april'),ylabel('energy/Whr')
hold off
```

```
%figure()
subplot(335)
hold on
plot(mayp,energyp5,May,Energy5,May,MayTavg,'Linewidth',3),title('energy in may'),xlabel('may'),ylabel('energy/Whr')
hold off
```

```
%figure()
subplot(336)
hold on
plot(junep,energyp6,June,Energy6,June,JuneTavg,'Linewidth',3),title('energy in june'),xlabel('junep'),ylabel('energy/Whr')
hold off
```

```
%figure()
subplot(337)
hold on
plot(julyp,energyp7,July,Energy7,July,JulyTavg,'Linewidth',3),title('energy in july'),xlabel('july'),ylabel('energy/Whr');
hold off
```

```
%figure()
subplot(338)
hold on
plot(augp,energyp8,Aug,Energy8,Aug,AugTavg,'Linewidth',3),title('energy in augpust'),xlabel('augpust'),ylabel('energy/Whr')
hold off
```

```
%figure()
subplot(339)
hold on
plot(septp,energyp9,Sept,Energy9,Sept,SeptTavg,'Linewidth',3),title('energy in september'),xlabel('september'),ylabel('energy/Whr')
hold off
```

```

figure()
subplot(131)
hold on
plot(octcp,energyp10,Oct,Energy10,Oct,OctTavg, 'Linewidth',3),ti
tle('energy in october'),xlabel('october'),
ylabel('energy/Whr')
hold off

```

```

%figure()
subplot(132)
hold on
plot(novcp,energyp11,Nov,Energy11,Nov,NovTavg, 'Linewidth',3),ti
tle('energy in november'),xlabel('november'),
ylabel('energy/Whr')
hold off

```

```

%figure()
subplot(133)
hold on
plot(decpc,energyp12,Dec,Energy12,Dec,DecTavg, 'Linewidth',3),ti
tle('energy in december'),xlabel('december'),
ylabel('energy/Whr')
hold off

```

```

figure()
subplot(311)
hold on
plot(Month, totalpenergyp,
Month,TotalEnergy, 'Linewidth',3),title('energy over the year
2013'),xlabel('Months'), ylabel('Energy/Whr')
hold off
subplot(312)
plot(Month,Temperature, 'Linewidth',3),xlabel('Months'),
ylabel('Temperature in Centigrade'), title('Variation of
Monthly average temperature over the year 2013 in Dhaka')
subplot(313)
plot(Month, Intensity, 'Linewidth',3),xlabel('Months'),
ylabel('Solar Illumination in W/m2'), title('Variation of
Monthly average solar illumination over the year 2013 in
Dhaka')

```

Practical data:

```

clc;
close all;
clear all;

```



```

%%11:00am mono
V1m=[20,19.7,19.6,19.5,19.3,19.1,18.8,18.6,18.5,18.2,18,17.8,1
7.2,17.1,16.4,15.9,15.6,15.3,15,13.6,12.5,10.7,7.7,6.7,1,0];
I1m=[0,.1,.13,.18,.25,.26,.32,.40,.42,.44,.46,.48,.55,.59,.64,
.71,.73,.76,.78,.8,.8,.81,.82,.84,.85,.87];
P1m=V1m.*I1m ;
P1mmax=max(P1m);
FF1m=P1mmax/(V1m(1)*I1m(end));

```

```

%%11:00am poly
V1p=[20.1,19.2,19.1,19,18.9,18.8,18.6,18.5,18.4,18.3,18.2,18,1
7.8,17.6,17.5,17.4,17.3,17.2,17.1,17,16.9,16.8,16.7,16.5,16.3,
16.2,15.8,15.2,13.9,13.7,13.4,12.8,11.3,10.6,8.9,6.1,6,0];
I1p=[0,0.14,.16,.18,.2,.23,.25,.27,.29,.31,.33,.40,.42,.45,.46
,.48,.49,.50,.51,.53,.54,.56,.58,.59,.60,.62,.63,.64,.71,.72,.
73,.74,.75,.76,.77,.77,.77,.77];
P1p=V1p.*I1p;
P1pmax=max(P1p);

```

```

%%11:30am poly
V2p=[20,19.8,19.7,19.5,19.3,19.1,19,18.8,18.6,18.5,18.4,18.3,1
8.2,18.1,18,17.9,17.8,17.6,17.4,17,16.7,16.5,16.1,15.8,15.7,13
.4,12.4,9.9,5.6,3.9,3,0];
I2p=[0,0.02,.1,.16,.22,.23,.27,.3,.32,.36,.38,.41,.44,.45,.48,
.49,.51,.56,.60,.66,.69,.74,.77,.80,.81,.82,.83,.83,.84,.84,.8
4,.84];
P2p=V2p.*I2p;
P2pmax=max(P2p);

```

```

%%11:30am mono
V2m=[20.3,19.2,18,17.5,16.7,16.1,15.8,15,14.2,12.6,10.3,6.1,4.
5,0];
I2m=[0,.44,.64,.71,.76,.80,.85,.88,.9,.91,.92,.94,.95,.99];
P2m=V2m.*I2m;
P2mmax=max(P2m);

```

```

%%12:00pm mono
V3m=[20.6,19.6,19,18.5,18,17.5,17,16.5,16.3,15.8,15.5,14.7,12.
4,8.9,2.6,0];
I3m=[0,.25,.38,.45,.52,.58,.63,.66,.67,.68,.69,.70,.71,.72,.73
,.73];
P3m=V3m.*I3m;
P3mmax=max(P3m);

```

```

%%12:00pm poly

```

```
V3p=[20.3,19.5,19.2,18.8,18.5,18,17.8,17.1,16.7,16.3,12.2,9.2,
6.8,3.8,2.7,0];
I3p=[0,.23,.35,.4,.48,.54,.61,.69,.76,.80,.81,.82,.83,.84,.85,
.86];
P3p=V3p.*I3p;
P3pmax=max(P3p);
```

```
%%1:00pm poly
```

```
V4p=[20.3,19.5,19,18.6,18.2,17.8,17.6,17.5,17,16.3,15.6,11.2,1
0.5,8.1,3.8,2.9,0];
I4p=[0,.24,.39,.48,.57,.61,.63,.65,.74,.76,.79,.8,.81,.82,.83,
.85,.85];
P4p=V4p.*I4p;
P4pmax=max(P4p);
```

```
%%1:00pm mono
```

```
V4m=[20,20,19.9,19.7,19.6,19.5,19.4,19.3,19.1,19,18.9,18.6,18.
4,18,17.7,17.6,17.4,17.3,17.2,16.7,16.6,16.2,16.1,15.6,15.3,15
,13.8,12.3,11.2,10.1,6,0];
I4m=[0,.12,.19,.23,.23,.25,.27,.32,.34,.38,.41,.45,.48,.53,.56
,.57,.58,.59,.61,.64,.65,.68,.69,.70,.71,.72,.74,.75,.76,.77,.
78,.82];
P4m=V4m.*I4m;
P4mmax=max(P4m);
```

```
%%2:30pm mono
```

```
V5m=[20.6,19.7,19.6,19.5,19.4,19.3,19.2,19.1,19,18.9,18.8,18.7
,18.5,18.4,18.3,18.2,17.6,17,14.5,11.1,8.1,6.6,2.8,0];
I5m=[0,.2,.22,.23,.26,.28,.30,.31,.32,.33,.35,.36,.40,.42,.44,
.46,.48,.51,.54,.56,.57,.58,.59,.60,];
P5m=V5m.*I5m;
P5mmax=max(P5m);
```

```
%%2:30pm poly
```

```
V5p=[20.7,19.7,19.5,19.4,19.3,19.1,19,18.9,18.8,18.7,18.5,18.4
,18.2,18,17.6,17,14.5,11.1,8.1,6.7,2.8,1.7,0];
I5p=[0,.23,.25,.27,.30,.32,.33,.35,.37,.39,.42,.44,.46,.48,.51
,.54,.56,.57,.58,.59,.60,.61,.61];
P5p=V5p.*I5p;
P5pmax=max(P5p);
```

```
%%3:30pm mono
```

```
V6m=[20.6,19.2,19,18.8,18.7,18.1,17.9,17.7,17,16.7,16.1,6.1,3.3,.3,0];
```

```
I6m=[0,.22,.23,.24,.30,.31,.32,.33,.34,.37,.38,.40,.40,.40,.40];
```

```
P6m=V6m.*I6m;
```

```
P6mmax=max(P6m);
```

```
%%3:30pm poly
```

```
V6p=[20,19.4,18.9,17.9,16.5,16.2,15.8,15.4,14.9,14.7,13.9,13.7,10.6,8.9,0];
```

```
I6p=[0,.12,.14,.15,.17,.18,.2,.21,.22,.22,.23,.24,.25,.25,.27];
```

```
P6p=V6p.*I6p;
```

```
P6pmax=max(P6p);
```

```
Pmaxp=[P1pmax,P2pmax,P3pmax,P4pmax,P5pmax,P6pmax]
```

```
Pmaxm=[P1mmax,P2mmax,P3mmax,P4mmax,P5mmax,P6mmax]
```

```
time=[11, 11.5, 12,13, 14.5, 15.5];
```

```
TSm=[34, 33.61, 30.73, 35.66,32.78,29.50];
```

```
TSp=[31,31.55,33.61,36.48,33.6,30.73];
```

```
Temp=[26, 26.5, 27, 28.25, 28, 27];
```

```
Intensity= [560.83,575.33,560.165,513.5,354.33,197];
```

```
p1=length(Pmaxm);
```

```
f2=2; b=1;
```

```
for f1=1:p1-1
```

```
    Em(b) = 0.5*(Pmaxm(f1)+Pmaxm(f2))*(time(f2)-time(f1));
```

```
    f2=f2+1;
```

```
    b=b+1;
```

```
end
```

```
Energym = sum(Em)
```

```
p2=length(Pmaxp);
```

```
f2=2; b=1;
```

```
for f1=1:p1-1
```

```
    Ep(b) = 0.5*(Pmaxp(f1)+Pmaxp(f2))*(time(f2)-time(f1));
```

```
    f2=f2+1;
```

```
    b=b+1;
```

```
end
```

```

Energyp = sum(Ep)

figure()
subplot(221)
hold on
plot(time,Pmaxm, time,TSm)
hold off
subplot(222)
hold on
plot(time,Pmaxp, time,TSp)
hold off
subplot(223)
plot(time, Temp)
subplot(224)
plot(time,Intensity)

```

Practical data with constant R_s :

```

clc;
clear all;
close all;
Iscmono=1.31;
Iscpoly=1.22;
q= 1.6e-19;
To=298;
n1m=1.25;
n1p=1.71;
k=1.38e-23;
Eg=1.12;
Rsm= 32.844e-3;
Rsp=11.3e-3;
Iolm= Iscmono/(exp((q*.6)/(n1m*k*To)));
Iolp= Iscpoly/(exp((q*.567)/(n1p*k*To)));
Intensity=[560.83,575.33,560.165,513.5,354.33,197];
time=[11,11.5,12,13,14.5,15.5];
TSm=[34, 33.61, 30.73, 35.66,32.78,29.50];
TSp=[31,31.55,33.61,36.48,33.6,30.73];
Temp=[26, 26.5, 27, 28.25, 28, 27];
max_iter=1000;
V=0:0.01:0.7;
l=length(V);
a= length(time);
tol=1e-3;
%%%Isc and Io calculation
for i=1:a
    Iscm(i)=Iscmono*(Intensity(i)/1000)*(1+0.0011*(TSm(i)));
    Iscp(i)=Iscpoly*(Intensity(i)/1000)*(1+0.0011*(TSp(i)));

```

```

        Iom(i)= Iolm*((TSm(i)+273)/To)^3 * exp(-
(Eg/(k/q))*(1/(TSm(i)+273)-1/To));
        Iop(i)= Iolp*((TSp(i)+273)/To)^3 * exp(-
(Eg/(k/q))*(1/(TSp(i)+273)-1/To));
end

%%Energy calculation for mono

p(1)= 1.31;
for i=1:a
for m=1:l

        Vtm=k*(TSm(i)+273)/q;

        f=@(x) (Iscm(i)-(Iom(i)*(exp((V(m)+x*Rsm)/(nlm*Vtm)))))-
x;
        df=@(x) -(Rsm*Iom(i)*exp((V(m) +
Rsm*x)/(Vtm*nlm)))/(Vtm*nlm) - 1;
for c=1:max_iter

        p(c+1)=p(c)-(f(p(c))/df(p(c)));
        err=abs((p(c)-p(c+1))/p(c));

if (err < tol)
break
end
end

I(m)=p(c+1);
p(1)= I(m);

end
%figure()
%plot(V,I)
%axis([0 1 0 1])
for d=1:length(V)
if I(d)>0
        P(d)=V(d)*I(d);
else
break
end
end

Pmax(i)= max(P);
Imax(i)=max(I);

end
figure();
subplot(211)
plot(time, Pmax*36),title 'time vs Pmax for mono for constant
Rs';

```

```

subplot(212)
plot(time, TSm), title 'time Vs Surface Temperature'
pl=length(Pmax);
f2=2; b=1;
for f1=1:pl-1
    Em(b) = 0.5*(Pmax(f1)+Pmax(f2))*(time(f2)-time(f1));
    f2=f2+1;
    b=b+1;
end

Energym = sum(Em)*36

%% Energy calculation for poly
p1(1)= 1.22;
for i=1:a
    for m=1:l

        Vtp=k*(TSp(i)+273)/q;

        f=@(x) (Iscp(i)-(Iop(i)*(exp((V(m)+x*Rsp)/(n1p*Vtp)))))-
x;
        df=@(x) -(Rsp*Iop(i)*exp((V(m) +
Rsp*x)/(Vtp*n1p)))/(Vtp*n1p) - 1;

        for c=1:max_iter

            p1(c+1)=p1(c)-(f(p1(c))/df(p1(c)));
            err=abs((p1(c)-p1(c+1))/p1(c));

            if (err < tol)
                break
            end
        end

        Ip(m)=p1(c+1);
        p1(1)= Ip(m);

    end
    %figure()
    %plot(V,I)
    %axis([0 1 0 1])
    for d=1:length(V)
        if Ip(d)>0
            Pp(d)=V(d)*Ip(d);
        else
            break
        end
    end
end

Pmaxp(i)= max(Pp);

```

```

Imaxp(i)=max(I);

end
figure();
subplot(211)
plot(time, Pmaxp*36),title 'time vs Pmax for poly for
constant Rs';
subplot(212)
plot(time,TSp), title 'time vs Surface Temperature'
pl=length(Pmaxp);
f2=2; b=1;
for f1=1:pl-1
    Ep(b) = 0.5*(Pmaxp(f1)+Pmaxp(f2))*(time(f2)-time(f1));
    f2=f2+1;
    b=b+1;
end

Energyp = sum(Ep)*36

```

Practical data calculation with varying R_s :

```

clc;
clear all;
close all;
Iscmono=1.31;
Iscpoly=1.22;
q= 1.6e-19;
To=298;
n1m=1.25;
n1p=1.71;
k=1.38e-23;
Eg=1.12;
Rsm= 32.844e-3;
Rsp=11.3e-3;
Iolm= Iscmono/(exp((q*.6)/(n1m*k*To)));
Iolp= Iscpoly/(exp((q*.567)/(n1p*k*To)));
Intensity=[560.83,575.33,560.165,513.5,354.33,197];
time=[11,11.5,12,13,14.5,15.5];
TSm=[34, 33.61, 30.73, 35.66,32.78,29.50];
TSp=[31,31.55,33.61,36.48,33.6,30.73];
Temp=[26, 26.5, 27, 28.25, 28, 27];
max_iter=1000;
V=0:0.01:0.7;
l=length(V);
a= length(time);
tol=1e-3;
%%Isc and Io calculation
for i=1:a
    Iscm(i)=Iscmono*(Intensity(i)/1000)*(1+0.0011*(TSm(i)));

```

```

        Iscp(i)=Iscpoly*(Intensity(i)/1000)*(1+0.0011*(TSp(i)));
        Iom(i)= Iolm*((TSm(i)+273)/To)^3 * exp(-
(Eg/(k/q))*(1/(TSm(i)+273)-1/To));
        Iop(i)= Iolp*((TSp(i)+273)/To)^3 * exp(-
(Eg/(k/q))*(1/(TSp(i)+273)-1/To));
end

%%Rs calculation for mono
for i = 1:a
    t = TSm(i);
    R(i)= (-3.4e-9 *t^4 + 2e-6 * t^3 + 0.00052* t^2 - 0.52 *t
+ 84)/84;
    Rsmono(i)=Rsm*(1000/Intensity(i))*R(i);

end

%%Rs calculation for poly
for i=1:a
    t=TSp(i);
    R(i)= (-3.9e-9*t^5 - 6.8e-6*t^4 + 0.0047*t^3- 1.6*t^2 +
2.8e+2*t + 2e+4)/(2e+4);
    Rspoly(i)=Rsp*(1000/Intensity(i))*R(i);
end

%% Energy calculation for mono
p(1)=1.31;
for i=1:a

for m=1:l

    Vtm(i)=k*(TSm(i)+273)/q;

    f=@(x) (Iscm(i)-
(Iom(i)*(exp((V(m)+x*Rsmono(i))/(n1m*Vtm(i))))))-x;
    df=@(x) -(Rsmono(i)*Iom(i)*exp((V(m) +
Rsmono(i)*x)/(Vtm(i)*n1m)))/(Vtm(i)*n1m) - 1;
for c=1:max_iter

    p(c+1)=p(c)-(f(p(c))/df(p(c)));
    err=abs((p(c)-p(c+1))/p(c));

if (err < tol)
break
end
end

I(m)=p(c+1);
p(1)= I(m);
end
% figure()
% plot(V,I)
% axis([0 0.7 0 1.5])

```



```

for d=1:length(V)
if I(d)>0
    P(d)=V(d)*I(d);
elsebreak
end
end

Pmax(i)= max(P);
Imax(i)=max(I);
end
figure()
subplot(211)
plot(time, Pmax*36),title 'time vs Pmax for mono for varying
Rs'
subplot(212)
plot(time, TSm), title 'time vs Temperature in C'
pl=length(Pmax);
f2=2; b=1;
for f1=1:pl-1
    E(b) = 0.5*(Pmax(f1)+Pmax(f2))*(time(f2)-time(f1));
    f2=f2+1;
    b=b+1;
end

Energym = sum(E)*36

%%Energy calculation for poly
p1(1)=Iscpoly;
for i=1:a

for m=1:l
    Vtp(i)=k*(TSp(i)+273)/q;

    f=@(x) (Iscp(i)-
(Iop(i)*(exp(((V(m)+x*Rspoly(i))/(nlp*Vtp(i))))))-x;
    df=@(x) -(Rspoly(i)*Iop(i)*exp((V(m) +
Rspoly(i)*x)/(Vtp(i)*nlp)))/(Vtp(i)*nlp) - 1;
for c=1:max_iter

    p1(c+1)=p1(c)-(f(p1(c))/df(p1(c)));
    err=abs((p1(c)-p1(c+1))/p1(c));

if (err < tol)
break
end
end

I1(m)=p1(c+1);

```

```

p1(1)= I1(m);
end
% figure()
% plot(V,I)
% axis([0 0.7 0 1.2])
P = V.*I1;

for d=1:length(V)
if I1(d)>0
    Pp(d)=V(d)*I1(d);
elsebreak
end
end

Pmaxp(i)= max(Pp);
Imax(i)=max(I1);
end
PP=(Pmaxp*36)+1.5;
figure()
subplot(211)
plot(time, PP),title 'time vs Pmax for poly for varying Rs'
subplot(212)
plot(time,TSp), title 'time vs Temperature in C'
pl=length(Pmaxp);
f2=2; b=1;
for f1=1:pl-1
    E(b) = 0.5*(PP(f1)+PP(f2))*(time(f2)-time(f1));
    f2=f2+1;
    b=b+1;
end

Energyp = sum(E)

```

Program that verifies our theoretical calculation with practical calculation:

```

clc;
clear all;
close all;

time=[11, 11.5, 12,13, 14.5, 15.5];
TSm=[34, 33.61, 30.73, 35.66,32.78,29.50];
TSp=[31,31.55,33.61,36.48,33.6,30.73];
Temp=[26, 26.5, 27, 28.25, 28, 27];
Intensity= [560.83,575.33,560.165,513.5,354.33,197];

%% practical data power
Pmaxp=[10.0440,12.7170,13.0400,12.5800,9.1800,3.2880];

```

```

Pmaxm =[11.7000,13.4300,13.4300,11.1090,8.6700,6.1790];

Energym1=47.5258;

Energyp1 =47.4935;

%calculation with fixed Rs
Pcrm=[11.3121,11.6447,11.5373,10.2318,7.1024,3.9219];
Pcrp=[9.2201,9.4198,8.9170,7.8027,5.3773,2.9105];

Energym2=40.9320;

Energyp2=31.6329;

%Calculation with varying Rs
Pvrp=[11.0688 11.4076 11.2714 9.9679 6.8019
3.6924];
Pvrp=[10.4823 10.6800 10.1752 9.0623 6.6900
4.2942];
Energym3=39.7330;

Energyp3=37.4295;

figure()
subplot(211)
hold on
plot(time,Pmaxm,'Linewidth',2)
plot(time,Pcrm,'Linewidth',2)
plot(time,Pvrp,'Linewidth',2), xlabel('time'),
ylabel('power'), title ('Power from MONO')
hold off

subplot(212)
hold on
plot(time,Pmaxp,'Linewidth',2)
plot(time,Pcrp,'Linewidth',2)
plot(time,Pvrp,'Linewidth',2), xlabel('time'), ylabel('power'),
title ('Power from poly')
hold off

```

ARDUINO CODE FOR TAKING DATA

```

#include <Wire.h>
#include "RTClib.h"
RTC_DS1307 RTC;

```

```

int relay = 44;

```

```

int r = 0;
void setup() {
  Serial.begin(9600);
  Wire.begin();
  RTC.begin();

  if (!RTC.isrunning()) {
    //Serial.println("RTC is NOT running!");
    // following line sets the RTC to the date & time this sketch was compiled
    RTC.adjust(DateTime(__DATE__, __TIME__));
  }
  pinMode(relay, OUTPUT);
  digitalWrite(relay, LOW);
}
void loop() {
  DateTime now = RTC.now();
  Serial.print(now.year(), DEC);
  Serial.print('/');
  Serial.print(now.month(), DEC);
  Serial.print('/');
  Serial.print(now.day(), DEC);
  Serial.print(' ');
  Serial.print(now.hour(), DEC);
  Serial.print(':');
  Serial.print(now.minute(), DEC);
  Serial.print(':');
  Serial.print(now.second(), DEC);
  Serial.println();
  delay(100);

  if(r<60){
    digitalWrite(relay, LOW);
    r++;
    int current_sensorValue = analogRead(A0); //Connect ACS714 to A0 Pin
    float voltage = current_sensorValue*(5.0/1024);
    //float current = (((0.00488281*current_sensorValue)-2.4576)/0.185);
    float current = ((voltage)-2.50)/0.185;
    Serial.print("Current 1: ");
    Serial.print(current);
    Serial.print(" A");
    Serial.println();

    float volt1 = analogRead(A7)*(5.0/1023)*3.86;
    Serial.print("Voltage 1: ");
    Serial.print(volt1);
    Serial.print(" V");
    Serial.println();
    delay(500);
  }
  //The above code will measure Current Through Panel

```

```

int sens_temp1 = analogRead(A2); //Connect Temperature Sensor1 to A2 Pin

float voltage_1 = sens_temp1*(5.0/1023);
float temperature1 = (voltage_1 + 0.048)/0.0119;

Serial.print("Temperature Panel 1 = ");
Serial.print(temperature1);
Serial.print("*C");
Serial.println();
delay(500);
}else if(r<120){
  digitalWrite(relay, HIGH);
  r++;
  int current_sensorValue = analogRead(A0); //Connect ACS714 to A0 Pin
  float voltage = current_sensorValue*(5.0/1024);
//float current = (((0.00488281*current_sensorValue)-2.4576)/0.185);
  float current = ((voltage)-2.50)/0.185;
  Serial.print("Current 2: ");
  Serial.print(current);
  Serial.print(" A");
  Serial.println();
  float volt2 = analogRead(A7)*5.0/1023*3.86;
  Serial.print("Voltage 2: ");
  Serial.print(volt2);
  Serial.print(" V");
  Serial.println();
  delay(500);
//The above code will measure Current Through Panel

  int sens_temp2 = analogRead(A3); //Connect Temperature Sensor1 to A2 Pin

  float voltage_2 = sens_temp2*(5.0/1023);
  float temperature2 = (voltage_2+0.048)/0.0119;

  Serial.print("Temperature Panel 2 = ");
  Serial.print(temperature2);
  Serial.print("*C");
  Serial.println();
  delay(500);
}
else {
  r = 0;
}
//
//The above code will measure Temperature of 2 Panels
}

```