

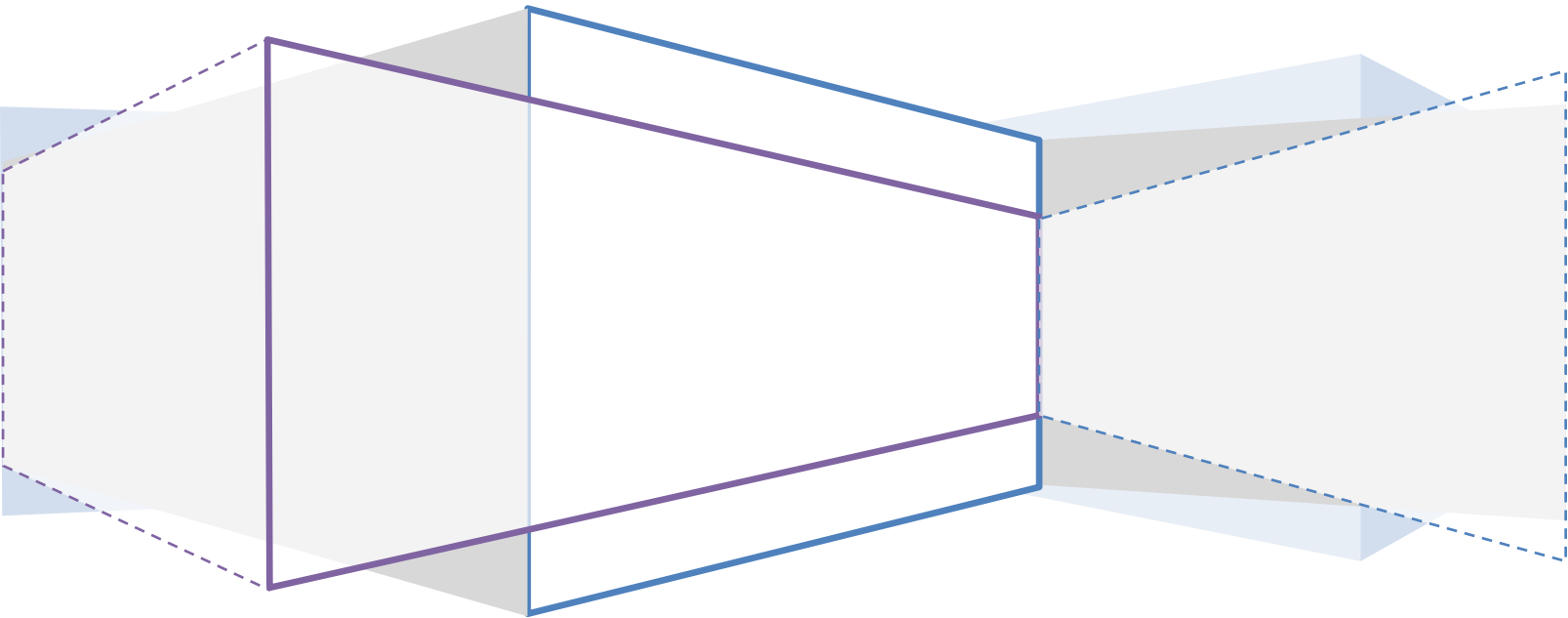

# **INTERNSHIP REPORT on “CREDIT RISK MANAGEMENT” of SOUTHEAST BANK LTD.**



**A report on “Credit Risk management”**  
**Of**  
**Southeast Bank Ltd. (Mohammadpur Branch)**



**Prepared for:**

Santu Kumar Ghosh  
Assistant Professor,  
Coordinator  
BRAC Business School,  
BRAC University

**Prepared by:**

Syeda Nazia Akhter  
ID: 09304099  
BRAC Business School  
BRAC University

Submission Date: **15<sup>th</sup> June, 2014**

## **Letter of Transmittal**

Date: 15<sup>th</sup> June, 2014

Santu Kumar Ghosh  
Assistant Professor,  
Coordinator, BBA program  
BRAC Business School,  
BRAC University.

**Subject: Submission of Internship Report.**

Dear Sir,

It is a great pleasure and privilege to present the internship report titled “**Credit Activities of Southeast Bank Ltd.**” which was assigned to me as a partial requirement for the completion of BBA Program.

Throughout the study I tried with the best of my capacity to accommodate as much information and relevant issues as possible and tried to follow the instructions as you have suggested. I tried my best to make this report as much informative as possible. I sincerely believe that it will satisfy your requirements. I however sincerely believe that this report will serve the purpose of my internship program.

I, therefore, pray and hope that you would kindly accept my report and oblige thereby.

With thanks and best regards.

Sincerely yours,

---

**Syeda Nazia Akhter**  
**ID NO: 09304099**  
BRAC Business School,  
BRAC University.

## Acknowledgement

For the very first of all I would like to express my gratefulness and harmony to Allah, the supreme authority of the Universe, without whom we would be nothing. Next I would like to express my kindness to my beloved parents whose continuous inspiration and blessings enragas me to make a right move in my life.

Then of all I would like to thank my Course Coordinator as well as Supervisor of the report Santu Kumar Ghosh without whose help, suggestion and co-operation the total report would be valueless.

I would also like to express my heartiest gratitude to the Manager & Executive Vice-President Md. Abdul Mannan of SEBL, Mohammadpur Branch. I have got tremendous help from him. I am also grateful to the Manager Operation & Senior Assistant Vice President (SAVP), Mr. Murad Mahmud for his constant help and support.

I would like to express my gratitude to Md. Mizanur Rahaman, (Senior Principle Officer) Mahadi Sabiar Rahman, (Senior Officer & credit In-charge). They always provided me the required materials and helped me to clarify the banking activities. This report will give me practical knowledge about the banking activities.

Finally, I would like to thank all the officers and workers of SEBL, Mohammadpur Branch for their co-operation, support and love.

I would like to thank from the deep of my heart to those people who are related with making of this report and make it a success.

Finally, I would like to thank BRAC University and its faculties of BBS Department for giving me an opportunity to complete my BBA degree and give me a scope to gather practical experience and enrich my knowledge.

---

**Syeda Nazia Akhter**

**ID: 09304099**

BRAC Business School,

BRAC University.

## **Executive Summary**

The Internship report has been prepared on “**Credit Risk Management of Southeast Bank Ltd.**” based on secondary data and information. The information used in the report has collected from various sources such as published materials like annual report, the credit manual of Bank. Daily statement of affairs of Mohammadpur branch and articles related to banking activities.

I have prepared this report to represent the available product & service facilities, service quality, their efficiency to serve customer, terms and conditions etc. Southeast Bank always tries to launch new products and services according to customers taste and preference. SEBL works with the aim to achieve service excellence and maximize shareholder’s value.

SEBL has not enough branches in different districts of Bangladesh. So SEBL should increase the number of their branch to get more customers. SEBL also has to consider their fees and charges & their formal procedure and should change them.

And from the financial performance analysis it is found that, Southeast Bank Ltd. had some difficulties in the past, but in the last five years, it experienced growth in their operations.. Their special banking services like – Internet Banking, Online Banking etc. are very effective to create customer satisfaction.

Southeast bank Ltd. had significantly reduced its various risk elements. All of its credit risk exposures show that the management has been able to reduce the credit risk.

There is more Private Bank in Bangladesh and that is why competition is very high. So it becomes a challenge for SEBL to retain its existing customers .There is a hope that, SEBL is always very conscious about its consumer banking and always try to make change with time want to modernize its products and services.

## **Table of Contents**

<u><b>Content</b></u>	<u><b>Page</b></u>
1. Introduction	1-5
2. Overview of banking industry in Bangladesh and Southeast Bank Ltd.	6-24
3. Overview of Mohammadpur Branch of Southeast Bank Ltd.	25-46
4. Job Responsibilities	47-63
5. Findings, Leanings and Recommendation	48-69
6. Conclusion	70-71
7. Reference	72-73

# Chapter-01:

# INTRODUCTION

# 1.INTRODUCTION

## 1.1 Origin of the Report

This report is a part of BBA program of BRAC University. For completion of BBA program in BRAC University, I shared my experience in this report regarding Southeast Bank Limited, Mohammadpur Branch, Dhaka where I have been working as an intern.

The report on “**Credit risk management** of Southeast Bank Limited, Mohammadpur Branch, and Dhaka” has been prepared under the supervision and guidance of Mr. Santu Kumar Ghosh, Assistant Professor, Coordinator, BBA program, BRAC Business School, BRAC University.

## 1.2 Background of the Report

This report is made to fulfill the partial requirement of the BBA program. As I have been working in Southeast Bank Limited, Mohammadpur Branch in Dhaka as Intern for three months, practical knowledge has been gathered on the **Credit risk management** department and the report is aimed to work on overall **Credit risk management** of Southeast Bank Ltd.

Practical work situation is different from what is learnt theoretically. Though the business processes are based on theory, the application has to be different to meet the requirement of a situation. The **Credit risk management** of the Southeast Bank Limited, Mohammadpur Branch, Dhaka, thus, has been observed practically and presented in this report.

## 1.3 Scope of the Report

Southeast Bank Limited (SEBL) is one of the leading banks in Bangladesh. The scope of the study is limited to the Branch level only. The report focuses upon the organizational structure and the financial services offered by SEBL and the performance of the bank.

This report covers **Credit risk management** of SEBL which deals with deposit, cash and remittance. This has been prepared through extensive discussion with bank employees and with



the customer. While preparing this report, I had a great opportunity to have an in depth knowledge of all the banking activities practices by the “Southeast Bank Ltd”. It also helps me to acquire perspective of a leading private banking in Bangladesh.

#### **1.4 Objective of the Report:**

##### **1.4.1 General objective of the report:**

The objective of the report is to bring Southeast Bank Ltd., its operation and activities into the light. It covers Overview of the Credit division, processes and other functions. It also covers Southeast bank's Products and Services, Organizational Overview, Management and Organizational functions performed by SEBL.

The report also aims at acquiring firsthand knowledge about “Credit risk management of Southeast Bank Ltd.” as well to suggest ways and means to improve the current practice.

##### **1.4.2 Specific objective of the report:**

- The main objective of the study is to develop an insight of credit risk management of Southeast Bank Ltd. and tools available to identify efficient methods used to mitigate overall Credit risks and to reduce loan default rate. The rational objectives are: To identify the main factors of the credit risk and computation of credit risk grading of Southeast Bank Limited.
- To identify the obstacles encountered when a loan is being default by Southeast Bank Limited and the ways to overcome the problems.
- To identify the causes how and why a loan defaults.
- To have an overall idea regarding the banking system of commercial Bank.
- To apply theoretical knowledge in the practical field.
- To observe the working environment in commercial banks.
- To know the Credit risk management system of SEBL.
- To appraise the total achievements and success of SEBL.
- To know about operation of Credit risk management of southeast Bank Limited.

- To know about the different products offered by the bank.
- Identify products and service quality level.
- To know about the rate and charges.
- To evaluate the customer service of the Southeast Bank Limited.
- To know about the client pattern.
- To study the risk involved during the banking operations.
- To find out how the reasons behind the risks are resolved by the management.

### 1.5 Methodology of the Report:

Sources of data collection:

*a) Primary data:* Collecting data directly from the practical field is called primary sources of data. The method that will be used to collect the primary data is as follows:

- **Interview:** Face to face conversation with the respective officers and staffs of the branch helped me to collect information.
- **Practical work experience:** Working in different desk of the branch helped me to collect some information that makes the report informative.
- **Group discussion:** Group discussion with other internee of the branch and my classmates is another way to make me informative.

*b) Secondary data:* The secondary data were collected to clarify different conceptual matters from internet and annual report used. Sources of secondary information can be defined as follows:

#### i) Internal sources:

- Bank's annual report.
- Group business principal manual.
- Group instruction manual and business instruction manual prior research report.
- Information regarding the banking sector.

#### ii) External sources:

- Different books and periodicals related to banking sector Bangladesh bank report.

- Website.
- Newspapers.

### **1.6 Limitations of the Report:**

In spite of best efforts there were limitations that acted as barriers to conduct the study.

- The main constraints of the study are insufficiency of information, which was required for the study. There are various information the bank officials cannot provide due to security and other corporate obligations.
- Time constraint.
- Limited access to data.
- All the employees of the bank are very busy. So they do not have much time to share information.
- All customers are not proactive or knowledgeable to share information.
- Due to the limitations of time and to protect the organizational confidentiality many aspects of the report are not in depth.
- Being public limited company, the private commercial banks like Southeast Bank Limited keep some information restricted like the actual amount of classified loans.
- Financial Statements only portray the figures/numbers and their break down but do not clarify the justification in most of the time.

**Chapter-02:**  
**OVERVIEW OF BANKING**  
**INDUSTRY IN**  
**BANGLADESH**  
**&**  
**SOUTHEAST BANK LTD. ,**

## **2.1 Banking System in Bangladesh:**

The Nation can look back with certain justifiable pride at the achievements of the banking sector of Bangladesh. In the wake of liberation struggle, the banking structures of Bangladesh were in shambles in the war ravaged economy of the country. The banking business in the country was performed entirely by the nationalized banks till 1981/82. Thereafter, some banks were allowed to function as private sector banks for the purpose of widening the area of private sector operation. Two nationalized banks, the Uttara Bank and the Pubali Bank Were denationalized, and they started operation as private commercial bank.

The banking system of Bangladesh has undoubtedly made significant strides during the last years. Banking network now covers the entire country. Commercial banks play a very important role in our economy; in fact, it is difficult to imagine how our economic system could function efficiently without many of their services. They are the heart of our financial structure since they have the ability, in co-operation with Bangladesh bank to add to the money supply of the nation and thus create additional purchasing power. This characteristic sets commercial Banks apart from other financial institutions. In addition to issuing deposits payable in demands, they accept time deposits. By Lending and investing these resources, and by transferring funds throughout the nation and even between countries, they make possible a more complete utilization of the resources of the nation. Although banks create no new wealth, their lending, investing and related activities facilitate the economic processes of production, distribution and consumption.

Human resource development through training is most crucial for organization growth. Training is a means to reduce obsolesce among the people in organization in the face of relentless innovation. Training is the process of increasing the skills and knowledge of personnel for the purpose of improving individual and organizational performance. Training is essential for the continued growth and development of both individual employee and the organization.

## List of Banks in Bangladesh

The commercial banking system dominates Bangladesh's financial sector. Bangladesh Bank is the Central Bank of Bangladesh and the chief regulatory authority in the sector. The banking system is composed of four state-owned commercial banks, five specialized development banks, thirty private commercial Banks and nine foreign commercial banks. The Nobel-prize winning Grameen Bank is a specialized micro-finance institution, which revolutionized the concept of micro-credit and contributed greatly towards poverty reduction and the empowerment of women in Bangladesh.

- Central Bank
- State-owned Commercial Banks
- Private Commercial Banks
- Foreign Commercial Banks
- Specialized Development Banks

### Central Bank : *Bangladesh Bank*

Pursuant to Bangladesh Bank Order, 1972 the Government of Bangladesh reorganized the Dhaka branch of the State Bank of Pakistan as the central bank of the country, and named it Bangladesh Bank with retrospective effect from 16 December 1971.

### State-owned Commercial Banks

The banking system of Bangladesh is dominated by the Nationalized Commercial Banks, which together controlled more than 54% of deposits and operated 3388 branches (54% of the total) as of December 31, 2004. The nationalized commercial banks are:

### Specialized Bank of Bangladesh:

- Karmosangesthan Bank
- Bangladesh Krishi Bank
- Sonali Bank
- Janata Bank
- Rupali Bank

### **Private Commercial Banks**

Private Banks are the highest growth sector due to the dismal performances of government banks (above). They tend to offer better service and products.

- BRAC Bank Limited
- Eastern Bank Limited
- Dutch Bangla Bank Limited
- Dhaka Bank Limited
- Pubali Bank Limited
- Uttara Bank Limited
- IFIC Bank Limited
- National Bank Limited
- The City Bank Limited
- United Commercial Bank Limited
- NCC Bank Limited
- Prime Bank Limited
- SouthEast Bank Limited
- Al-ArafahIslami Bank Limited
- Social Islami Bank Limited
- Standard Bank Limited
- One Bank Limited
- Exim Bank Limited
- Mutual Trust Bank Limited
- First Security Islami Bank Limited
- The Premier Bank Limited
- Bank Asia Limited
- Trust Bank Limited
- ShahjalalIslami Bank Limited
- Jamuna Bank Limited
- ICB Islami Bank
- AB Bank Limited

### **Foreign Commercial Banks**

- Citibank
- HSBC
- Standard Chartered Bank
- Commercial Bank of Ceylon
- State Bank of India
- Habib Bank
- National Bank of Pakistan
- Woori Bank
- Bank Alfalah

### **Specialized Development Banks**

Out of the specialized banks, two (Bangladesh Krishi Bank and RajshahiKrishiUnnayan Bank) were created to meet the credit needs of the the agricultural sector while the other two ( Bangladesh Shilpa Bank (BSB) & Bangladesh ShilpaRinSangtha (BSRS) are for extending term loans to the industrial sector. The Specialized banks are:

- Grameen Bank
- The Dhaka Mercantile Co-operative Bank Ltd
- Bangladesh Krishi Bank
- Bangladesh Development Bank Ltd
- RajshahiKrishiUnnayan Bank
- BASIC Bank Limited (Bangladesh Small Industries and Commerce Bank Limited)
- Bangladesh Somobay Bank Limited(Cooperative Bank)
- Ansar VDP Unnyan Bank



## **2.2 Background of Southeast Bank Limited**

Southeast Bank Limited (SBL), “A Bank with Vision”, emerged in the Commercial Banking Industry of Bangladesh in 1995. It was incorporated on March 12, 1995 as a public limited organization according to the Companies Act 1994. The commencement of its banking operations occurred on May 25, 1995 by the Principal Branch located at 1, Dilkusha Commercial Area, Dhaka.

The inception of SEBL is the outcome of a successful group of prominent and non-resident Bangladeshi investors whose vision was to contribute to the country’s economy through commercial banking.

Southeast Bank Limited began its services with the inaugural Chairman Mr. Mohammad AbulKashem, Vice Chairman Mr. Ragib Ali and the former President and Managing Director Mr. Shah Mohammad Nurul Alam. In 1995, the Bank used to provide services to its clients through only five branches situated in different strategic locations and has increased its total number of branches to 19 by 2002. The number of employees in 2003 stood over 600. Bangladesh Institute of Bank Management (BIBM) and other training institutes are providing regular training and orientation courses to update the skills and knowledge of the officers and staffs of the Bank.

Although the Bank is considered as the 2nd generation bank and has been in operation for only 8 years, it has begun fierce competition with its other contemporary banks. Southeast Bank Limited was licensed as a scheduled bank. It is engaged in pure commercial banking and providing services to all types of customers ranging from small entrepreneurs to the large business organizations. It is working for the economic welfare by transferring funds from the surplus economic unit to the deficit economic unit.

### **Mission**

The mission of the Bank is to obtain a sustainable position in the banking sector of Bangladesh as well as international banking area. For this, SBL has been consolidating its position and

preparing itself for the new age by upgrading technology, training its workforce, recruiting organizationally, and creating a better work culture.

## **Vision**

Its vision is “To reduce the investment and savings gap of the economy by savings mobilizations and encourage the pace of industrialization”.

## **Objectives**

- To provide standard financial service
- Wealth Maximization

## **Strategies**

The business strategy of the Bank is to strengthen its traditional lending in small retail business, following a conservative lending approach in the areas of large and medium industrial ventures. The management approach of maintaining loan quality is another strategy. Realizing the importance of having a good network for its entry to low cost savings deposits, the Bank has taken a dynamic step for opening additional branches.

## **Core Values**

- Integrity
- Respect
- Fairness
- Harmony
- Team spirit
- Courtesy
- Commitment
- Service Excellence
- Enthusiasm for Work
- Business Ethics

### **Core Strengths**

- Transparent and quick decision making;
- Efficient team of performers
- Satisfied customers
- Internal control
- Skilled risk management
- Diversification

### **Core Commitments**

Ours is customer focused modern banking institution in Bangladesh. Our business motives center on the emerging needs of the market our commitments to the clients re the following:

- Provide service with high degree of professionalism and use of modern technology.
- Create life-long relationship based on mutual trust and respect.
- Response to customer needs with quickness and accuracy.
- Sharing their values and beliefs
- Grow as our customers grow.
- Provide products and services at Competitive pricing
- Ensure Safety and security of customers' valuables in Custody with us.

### **Corporate Culture**

Southeast Bank is one of the most disciplined Banks with a distinctive corporate culture. The people of bank can see and understand events, activities, objects and situation in a distinctive way. They mould their manners and etiquette, character individually to suit the purpose of the Bank and the needs of the customers who are of paramount importance to them The people in the Bank see themselves as a tight knit team/family that believes in working together for growth. The corporate culture they belong has not been imposed; it has rather been achieved through their corporate culture.

### **Corporate Slogan**

.....A bank with vision

**The Board of Directors**

The Board of Director consists of the Chairman of the Bank, the Vice-Chairman of the Bank, Directors, the President and Managing Director, and the Company Secretary. This is the highest body of the Bank. Here is the organogram of Head office of Southeast Bank Ltd :

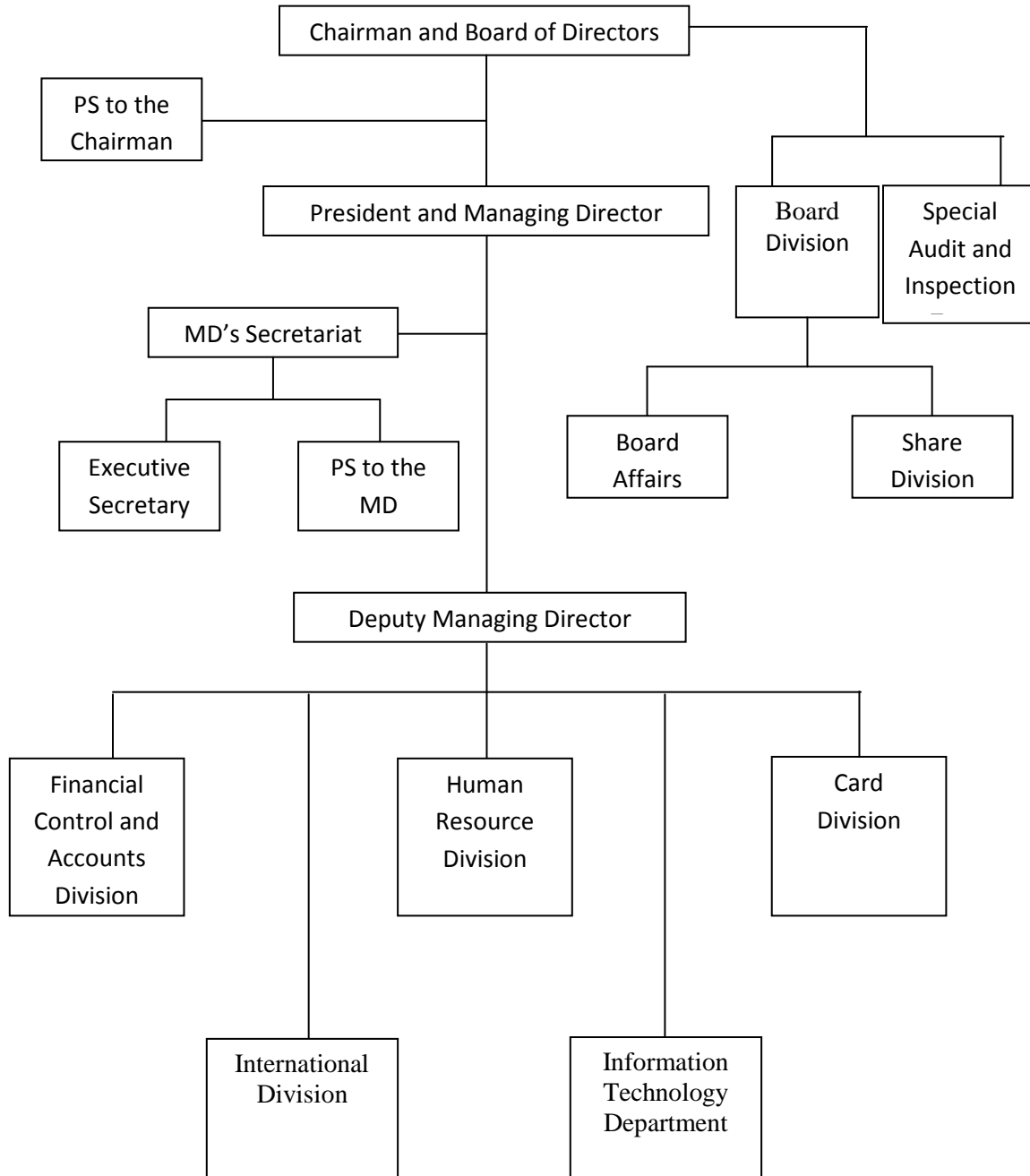

**Figure :** Organogram of Head Office, Southeast Bank Limited

Organization Structure:

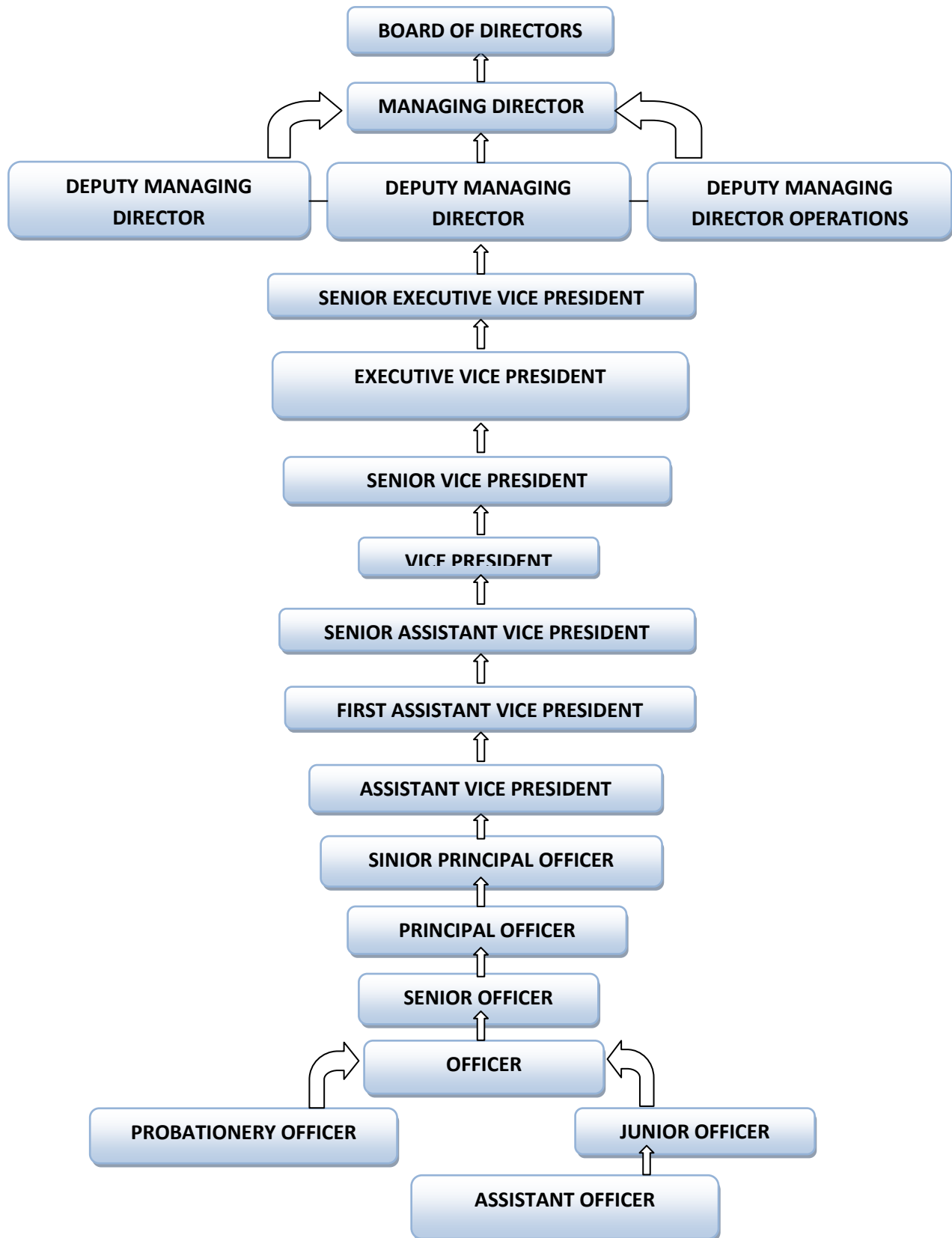

## **Management Team**

The team is lead by the President and Managing Director of the Bank. The Bank at present has 1 Deputy Managing Director, 5 Senior Executive Vice Presidents, 5 Executive Vice Presidents, 4 Senior Vice Presidents, and 8 Vice Presidents.

## **Functional Divisions of SEBL**

The Bank accomplishes its functions through different functional divisions/ departments. The functions of these divisions/ departments are described below.

### **(i) Financial Control and Accounts Division**

Main functions of this division are- Budgeting, Payment of salary, Controlling inter-branch transaction, Financial Analysis, Disbursement of bills, Preparing financial reports and annual reports, Reconciliation

### **(ii) International Division**

Followings are the major functions of this division: Correspondence banking, Compile and circulate the foreign exchange circulars to the branches, Reconciliation of Nostro Accounts, Preparing daily exchange rates, Foreign remittance, Consolidation of the overall foreign exchange business handled by the branches

### **(iii) Credit Division and Loan Administration Department**

Major Functions of these divisions are- Loan administration, Loan disbursement, Project evaluation, Processing and approving credit proposals of the branches, Arranging different credit facilities, Providing related statements to the Bangladesh Bank and other departments

#### **(iv) Human Resource Division**

Among different functions of the division, some important ones are as follows: Recruiting, Training and development, Compensation and employee benefits, Placement of employees, Preparing related reports, Reporting to the Executive Committee/ Board on related matters, Promotional campaign and press release

#### **(v) Information Technology Department**

This department mainly does the followings: ATM card and system operation, Software development, Network management, Software and Hardware management, SWIFT operation, Member banks reconciliation, Data entry and processing.

#### **(vi) Branches Control Division**

Main functions of this division are- Controlling different functions of the branches, Conducting audit and inspection regularly and suddenly, Ensuring compliance with the Bangladesh Bank

#### **(vii) Board Division**

Major Functions of the Division are- Maintenance of different Board matters, Preparation of extracts and minutes, Forwarding different memos to the Board of Directors/ Executive Committee, Administration of company's share related affairs

### **Products & Services of SEBL**

These are some products of Southeast Bank Limited under conventional banking system:

#### **Products:**

##### **Deposit Products:**

- I. Saving Account
- II. Current Account
- III. Special Notice Account

- IV. Fixed Deposit Receipt
- V. Double Benefit Scheme
- VI. Millioner Deposit Scheme
- VII. Monthly Savings Scheme
- VIII. Monthly Income Scheme
- IX. Pension Scheme

**Loans and Advance Products:**

- I. Working Capital Finance
- II. Overdraft
- III. Project Finance
- IV. Syndicated Loan
- V. Packing Credit
- VI. Loan Against Export Bill
- VII. Loan Against Trust receipt

**Islamic Banknig Products:**

- I. Mudaraba Savings account
- II. Al- Wadiah Current Account
- III. Mudaraba Special Notice Deposit (MSND) Account
- IV. Mudaraba Term Deposit Receipt
- V. Mudaraba Double Benefit Scheme (MDBS) Account
- VI. Mudaraba Hajj SanchayProkalpa
- VII. Mudaraba Millionaire Deposit Scheme

**Services:**

**Export Services**

Southeast Bank Limited offers a wide range of export services. Routing all export related transactions through Southeast Bank Limited could eliminate many of exporting hassles. With our expertise and experience, we can structure and customize solutions for specific requirements.



**Import Services:**

Southeast Bank Limited offers comprehensive range of Import services. Southeast Bank Limited is highly respected in the world of international finance and cross border transactions. Through our expertise and experience, they can structure and customize solutions suited to specific business requirements.

**Remittance Business:**

Although Southeast Bank has entered into remittance late compared to the other private banks, it has continuously strived to build its remittance business around quality service by making it easy for remitters to remit money through a network of agreements with reputed banks and remittance houses abroad and an extensive network in the country to deliver the money to the beneficiaries at their door in the quickest possible time and without hassles.

**Small & Medium Enterprise (SME) Banking**

Bank provides credit facilities to the small and medium entrepreneurs to be more productive and stable. There are 3 programmes for SME Banking :

1. Southeast Shopan
2. Southeast Shikhor
3. Southeast Shuprova

**Dual Currency VISA Credit Card**

SEBL Visa (Dual) Credit Card has unique feature of allowing limits both for local and international usage in a single card. However, one may opt for separate cards if he / she find the same convenient for him / her. SEBL Visa (Dual) Credit Card is accepted at any merchant locations or payment counters displaying Visa logo in any part of the world.

**SWIFT Services**

The Society for Worldwide Inter Bank Financial Telecommunication ("SWIFT") operates a worldwide financial messaging network. Messages are securely and reliably exchanged between banks and other financial institutions. Southeast Bank Limited has SWIFT services. The Bank's SWIFT address is SEBD BD DH.

**Locker Services**

Southeast bank offers locker facilities to its clients in various branches. It offers small, medium and large lockers at different service charge.

**ATM Services**

Southeast Bank Limited is a member of the E-cash Shared ATM Network. E-Cash has a network of 32 ATM's located in strategically important locations on five important cities / towns of the country namely: Dhaka, Chittagong, Sylhet, Cox's Bazar and Rajshahi. It is providing ATM service coverage to our 30 branches.

**Branch Expansion**

Southeast Bank Limited has already passed eleven years of its business operations. Within this period it has already set-up fifty eight branches around the around the country. These branches have been spread around four major divisions within the country. SEBL is considering opening more branches at Dhaka City and other important cities in a few months.

**BACH and BEFTN**

Southeast Bank Ltd. is one of the successful banks which have implemented Bangladesh Automated Clearing House (BACH) and Bangladesh Electronic Fund Transfer Network (BEFTN).

**Internet Banking**

Southeast bank Ltd has recently implement Internet banking service to its customers so that they can do: Account Balance Inquiry, Account Statement View and Download, Account Information View, Cheque Leaf Stop for payment Request and Cheque Book Issue Request from any remote PC having internet connection.

**Number of Employees**

The bank has 1655 employees in banking, and 355 employees in nonbanking. The Bank has plans to join more employees in the current fiscal year to expand.

Year		2003	2004	2005	2006	2007	2008	2009	2010	2011	2012
No Of Emplo yees	Ban king	586	685	759	845	964	1080	1254	1373	1526	1655
	Non Ban king	115	150	154	153	152	151	148	240	322	355

### Growth of Branch

Operational excellence coupled with qualitative improvements continued to be of paramount importance to the bank. The bank has 94 branches and 2 Off-shore Units across the country. Plan have been drawn to rise another 10 branches and 10 more SME/Krishi Branches in 2013. Our journey towards greater operational success continues with increased energy and enthusiasm.

Year	2002	2003	2004	2005	2006	2007	2008	2009	2010	2011	2012
No Of Branch	19	23	27	31	31	38	46	56	76	84	94

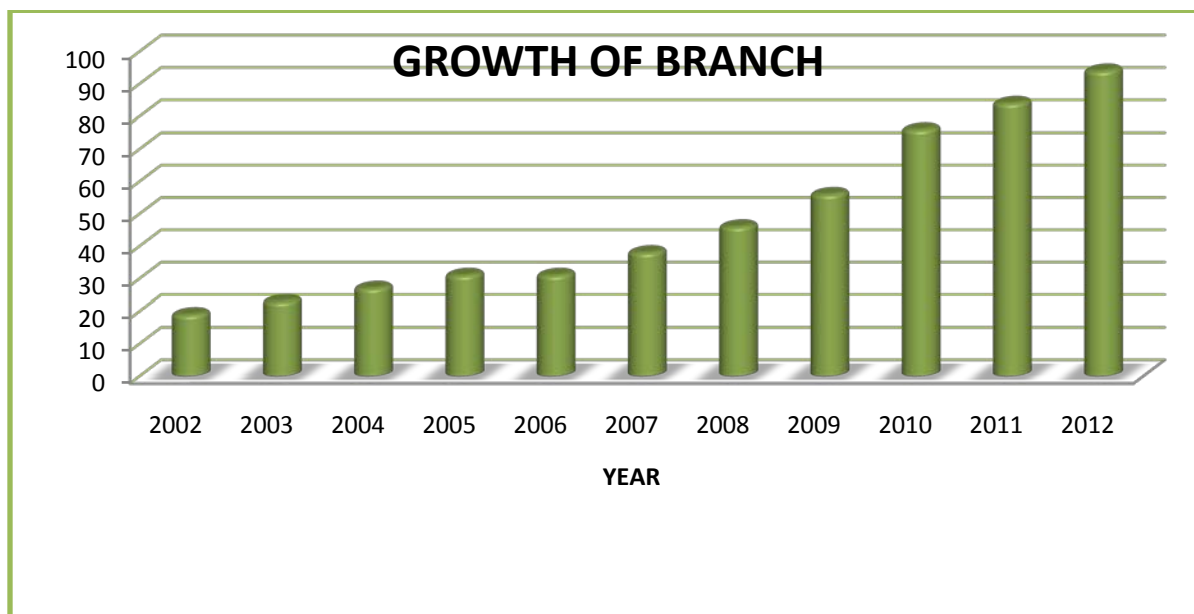
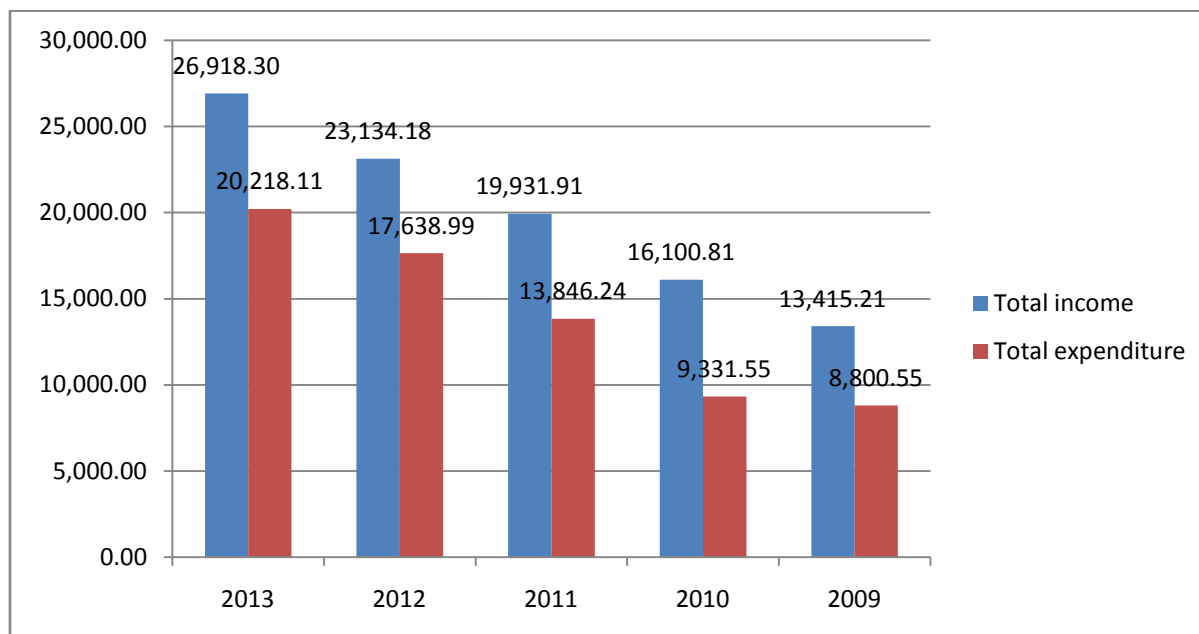

**Fig : Growth of Branch ( From 2002 to 2012)**

#### **Total Income and Total Expenditure:**

Total Income of the Bank stood at Tk 26,918.30 in 2013 as against Tk 23,134.18 of the previous year 2012 and Total Expenditure of the Bank stood at Tk 20,218.11 in 2013 as against Tk 17,638.99 of the previous year 2012. Total Income and Total Expenditure for the last 5 years are given below:

#### **Total Income and Total Expenditure (2013-2009)**



Source: Southeast Bank Limited Annual Report 2013

## Performance of SEBL at a glance

*Taka in Million (where applicable)*

Particulars	2013	2012	2011	2010	2009
Authorized Capital	10,000.00	10,000.00	10,000.00	10,000.00	10,000.00
Paid up Capital	8,732.86	8,732.86	8,317.01	6,930.84	3,422.64
Reserve fund and other Reserve	13,074.71	10,864.68	10,683.05	10,265.96	6,504.52
Total capital	21,807.57	19,597.54	19,000.06	17,196.80	9,927.16
Deposits	1,77,519.46	1,52,901.24	1,27,178.22	1,07,253.19	96,669.05
Advances	1,34,863.82	1,26,968.97	1,07,288.56	93,981.20	77,497.57
Investments	57,589.06	39,011.28	29,846.60	18,869.07	21,350.23
Import Business	1,31,644.82	1,11,537.50	99,509.01	1,03,726.70	69,582.92
Export Business	95,220.40	84,464.20	75,982.06	58,158.06	46,724.47
Foreign Remittance	39,299.10	41,455.40	49,544.10	28,082.25	23,779.20
Guarantee Business including ILC	17,226.41	21,506.65	25,673.90	22,781.19	11,916.74
Total income	26,918.30	23,134.18	19,931.91	16,100.81	13,415.21
Total expenditure	20,218.11	17,638.99	13,846.24	9,331.55	8,800.55
Operating Profit	6,700.20	5,495.19	6,085.67	6,769.26	4,614.66
Net profit after Tax and provision	3,378.82	1,648.72	1,912.19	2,763.93	1,870.19
Fixed Assets	7,795.65	7,677.51	7,373.11	4,463.64	4,323.59
Total Assets	2,20,930.85	1,91,276.30	1,58,078.59	1,31,784.27	1,12,676.98
Earnings per share (EPS) (TK)	3.87	1.89	2.19	3.77	3.24
Dividend Cash (%)	16%	15%	15%	10%	-
Bonus Shares	5%(20:1)		5%(20:1)	20%(5:1)	35%(20:7)
Return on Equity (ROE)	16.20%	8.42%	10.47%	19.41%	16.51%
Return on Assets (ROA)	1.64%	0.95%	1.32%	2.26%	1.66%
Non Performing Loan	3.94%	4.47%	3.51%	4.26%	3.73%
Number of Correspondent Banks	211	183	161	152	146

Number of Foreign Correspondents	778	691	654	645	589
Number of Shareholders	65,413	64,060	68,039	66,898	22,152
Number of Employees Banking	1,704	1,655	1,526	1,373	1,254
Non Banking	414	355	322	240	148
Number of Branches	103	94	84	76	56

Five years Financial Highlights

Source: Southeast Bank Limited Annual Report 2013

### CSR Activities :

Southeast bank emphasizes its CSR activities to increase Bank's Bank image. As a result , It is focusing on the fields ,given below :

- Donating fund for Building Hospitals
- Providing fund for sporting event
- Establishing school ( Southeast Bank Green School)
- Contributing during natural calamities.
- Offering Scholarships for bright students , already 828 students are under this Scholarship Program.

**Chapter-03:**  
**OVERVIEW OF**  
**MOHAMMADPUR**  
**BRANCH**  
**OF**  
**SOUTHEAST BANK LTD.**

### 2.3 About Mohammadpur Branch, SEBL

Southeast Bank started his journey in Mohammadpur area as Mohammadpur Branch in November, 2009. It is the 54<sup>th</sup> branch of Southeast Bank Ltd. It situated in Aurogheb Road .Bank chose this location as there are so many schools and colleges in this area. As a result so many families live in this area and also their kids used to study in the school nearby. So, many parents used pay their school or college fees in this branch and gradually become loyal customers and client of this branch. Also, there are many small IT companies, developer companies, entrepreneurs who daily having lots of transactions through our branch. However, our branch's main clients are individual clients mainly housewives, retired senior citizens, school teachers and staffs of the companies or organization who regularly deals with Mohammadpur Branch. Though, this branch does not have so many clients like the other banks' branch (For example. Prime bank etc) . As they started work in Mohammadpur before Southeast Bank Ltd and grab the major amount of customers. Still, Southeast bank able to attract its customers through it's' schemes and services and gradually the number of customers increases day by day.

When it first started its journey, there were 13 officers. Now they have 18 staffs including Manager and Manager in Operation. Here is an organogram of Mohammadpur Branch, given in next page :



**Hierarchy:**

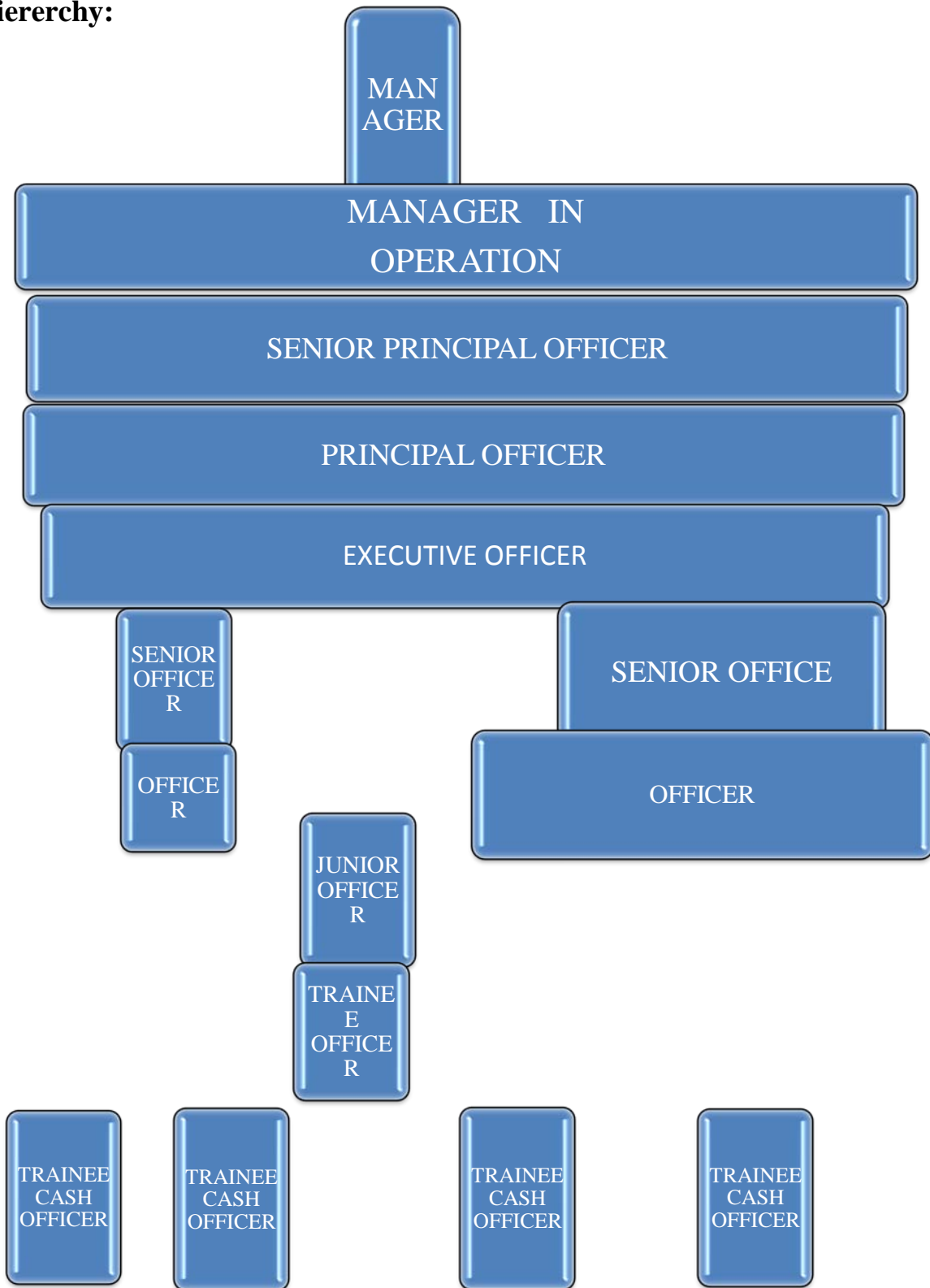

## **CREDIT ACTIVITIES OF SOUTHEAST BANK LTD .**

Almost in every bank , there are 4 basic departments . They are :

4. General Banking ( Including account opening, issuance of cheque book, FDR, Clearing, Cash, Pay order, etc)
5. Credit
6. Foreign exchange
7. Accounts and Logistics

### **Account Opening Section:**

To establish a banker and customer relationship account opening is the first step. Opening of an account binds the Banker and customer into contractual relationship. But selection of customer for opening an account is very crucial for a Bank. Indeed, fraud and forgery of all kinds start by opening account. So, the Bank takes extremely cautious measure in its selection of customers.

The following works are done by this section-

1. Accepting of deposit
2. Opening of account
3. Check book issue
4. Closing of account

### **Accepting of Deposit:**

Accepting deposits is one of the main classic functions of banks. The relationship between a banker and his customer begins with the opening of an account by the former in the name of the latter. Initially all the accounts are opened with a deposit of money by the customer and hence these accounts are called deposits accounts. There is two officers performing various functions in this department. The deposits those are accepted by SEBL may be classified in to:

- Demand deposit
- Time deposit

## A. Demand Deposit:

There are mainly two types of demand deposit accounts, this are:-

### i. Savings A/c:

To encourage savings habit amongst the general public, bank allows depositors to open savings account. As the name indicates, these accounts are opened for the purpose of savings. Interest is awarded on the balance of the account.

- The minimum balance requires to be maintained at all times is Tk. 1,000.00. And the bank reserves the right to change the minimum balance requirement and/or to close such accounts without prior notice if the balance falls below this amount.
- The maximum interest bearing amount allowed on any Saving Bank account Tk.50,00,000.00 interest is payable on collected funds.
- The Bank reserves to itself the right not to pay any Cheque presented that contravenes the rules. In the event of a Cheque being returned for want of funds a penalty charge of Tk.50.00 for each presentation will be made.

Term	Revised Rate of Interest
Saving Deposit	6.00% (No restriction on withdrawal)

### ii. Current A/c:

Current account is an account where the account holder within the funds can make numerous transactions available in its credits. No interest is paid on those deposits. Requirements to open an account are almost same to that of savings account except the initial deposit and the introducer must be the current account holder. Requirement for different types of current account holder are given below:

**a. Limited Company:**

A separate account opening form is used for Limited company. The bank should be cautious about opening account for this type of customer. Requirements to open an account are as follows:

- Articles of association
- Two copies of attested photograph
- Letter of commencement
- Letter of incorporation
- List of directors, their number of shares and status
- Memorandum of Association
- Registration-which the company is registered and certificate relating to this issue, is obtained from the registration office of Joint Stock Company.

**b. Partnership Firm:**

Same account opening form for partnership firm is used. Instruction of account is given in this form. Documents required to open this type of account are as follows:

- Two copies attested photograph of those who will operate the account.
- Partnership deed
- Resolution of the firm regarding account opening should be given
- Trade license

**c. Personal Current A/c:**

Same account opening form for partnership firm is used. Instruction of account is given in this form. Document required to open personal current account are given below:

- Two copies photograph of who will operate the account
- The guarantor who is already maintaining an account introduces personal.
- One copy photograph of nominee
- One photocopy of national ID of both , Account holder and nominee.

**d. Proprietorship A/c:**

Requirements for opening this type of account are as follows:

- The guarantor attests two copies photograph of who will operate the account.

- Photocopy of trade license.

**f. Co-operative Society:** Following documents have to be obtained in case of the account of Co-operative Society:

- i) Copy of Bye-Law duly certified by the Co-operative Officer.
- ii) Up to date list of office bearers.
- iii) Resolution of the Executive Committee as regard of the account.
- iv) Certified copy of Certificate of Registration issued by the registrar, Co-operative societies.

**g. Minor Account:** Following documents have to be obtained in case of the account of minor:

- i) Putting the word “MINOR” after the title of the account.
- ii) Recording of the special instruction of operation of the account.

The AOF is to be filled in and signed by either the parents or the legal guardian appointed by the court of law and not by the minor.

Banks are maintained a signature card and different types of register to open every types of accounts. An account number is given for each account and the description of the account entered in the computer. According to rules of the bank a letter of thank should be given to the account holder and to the introducer but in practice it is not done

### **iii. Monthly Schemes:**

#### **a. Mudaraba Monthly Savings Scheme (MMSS)**

Duration:3 (three) Years & 5 (Five) Years Amount of Monthly Installment: TK.500 or Multiple amount up to TK.50, 000 (Fifty Thousand).

1. A Person of 18 years of age and above having a sound mind can open the account
2. A Person can open more than one MMSS account at any branch of the Bank and in such case separate form should be filled
3. A passport size Photograph is required to open the account
4. MMSS account can be opened at any working day of the month.

5. Account opened within first 10th of any month will be treated as account of that particular month. If the account is opened after 10th of any month in that case 1st installment will be due and realized from the next month.

6. MMSS account cannot be opened in the name of any minor, in joint names, or in the name of institution.

7. An account can be transferred from one Islamic Branch to another Islamic Branch of the Bank by a written application of the account holder. In such case a fee of TK. 500 is payable as bank service charge.

8. Installments can be deposited in advance.

### **b. Pensions Savings Scheme (PSS)**

Duration: 4, 6 and 8 Years Terms

Amount of Monthly Installment's 500 or multiple up to TK. 25, 000 (i.e. Tk. 500 or 1000 or 1500)

1. A Person of 18 years of age and above having a sound mind can open the account

2. A person can open more than one PSS account for different amount at any branch of the Bank and in such case separate form should be filled in.

3. A passport size photograph of the account holder and each nominee (attested by the account holder) are required to open the account

4. The account can be opened at any working day of the month.

5. Account opened within 10th of any month will be treated as account opened on the particular month. If the account is opened after 10th of any month in that case 1st installment will be due from the following month and will be realized in the following month.

6. PSS account can be opened in the name of minor. In that case minor's legal guardian can operate the account.

7. Account cannot be opened in joint names, or in the name of any institution.

### **c. Double Benefit Scheme (DBS)**

Double Benefit Scheme is a time specified deposit scheme for clients where the deposited money will be doubled on maturity.

Features and Benefits:

- Amount to be deposited TK 10,000 or its multiple; No fees and charges.
- Deposited amount will be doubled in 7.5 years;

- Account can be opened at any working day of the month;
- Allowed to open more than one DBS Account at any branch of the Bank;
- Loan facility against lien of DBS Account;
- The Scheme is covered by Insurance and Insurance Premium is borne by the bank;
- Premature closure facility.
- Eligibility
- DBS Account can be opened for Individual, joint account and Corporate bodies.
- Only Resident Bangladeshi National is allowed to open Personal DBS Account
- Age bar for opening of Personal DBS Account: 18 years or above.
- Minor account can be opened under the supervision of his / her / their guardian.

#### **d. Millionaire Deposit Scheme (MDS)**

Millionaire Deposit Scheme is a time specified monthly deposit scheme for clients where the deposited money will become millions on maturity.

##### **Features and Benefits**

- Tenor: 4,5,6,7,8,9 and 10 years term;
- Deposit on monthly installment basis;
- Attractive rate of interest;
- Account can be opened at any working day of the month;
- Monthly installment can be deposited through a standing debit instruction from the designated CD/SB Account;
- Monthly installment can be deposited in advance;
- An account can be transferred from one branch to another branch of the bank;
- Credit facility for maximum of 2 years can be availed at any time during the period of the scheme;
- Allowed to open more than one MDS Account for different amount at any branch of the Bank

##### **Eligibility**

- MDS Account can be opened for Individual, joint account and Corporate bodies.
- Only Resident Bangladeshi National is allowed to open Personal MDS Account.
- Age bar for opening of Personal MDS Account: 18 years or above. However, Minor account can be opened under the supervision of his / her / their guardian.

## Fees & Charges

- Account transfer fee is Taka 500/-;
- Account closure fee is Taka 500/-;
- Penalty of Taka 200/- for failure to pay monthly installment within the stipulated time;
- VAT applicable for all fees & charges @15%.

### e. Multimillionaire Gold Deposit Scheme (MGDS):

A person of 18 years of age and above can open the account. MDGS account can be opened in joint names and in the name of any institution. Monthly installment can be deposited by cash/cheque or can be deposited through a standing debit instruction from the designated SB or CD account of every month. Monthly installment can be deposited in advance. In that case no interest for the advanced installment will be paid.

## B. Time Deposit:

There are mainly two types of time deposit:

### i. Short Term Deposit (STD):

In short term deposit, the deposit should be kept for at least seven days to get interest. The interest offered for STD is less than that of savings deposit. In PBL, various big companies, organization, Government Departments keep money in STD account. Frequent withdrawal is discouraged and requires prior notice.

Sl. No.	TERM	Revised Rate of Interest
1	Short Term Deposit	4.00% (no restriction on minimum balance)

### ii. Fixed Deposit Receipt (FDR):

Fixed Deposit Receipt offers the customers the opportunity to invest a fixed amount for a fixed period at a fixed rate of interest. The customers have the option to re - invest their funds both principal amount and interest amount on maturity or principal amount and the interest amount being paid into their SB or CD accounts. In FDR :



- Money can grow with attractive interest rate with flexible tenure.
- Automatic renewal facility at maturity.
- Loan facility against FDR to meet urgent financial needs.
- Premature closure facility at savings rate.
- Eligibility
- FDR Account can be opened for Individual, joint account and Corporate bodies.
- Only Resident Bangladeshi National is allowed to open Personal FDR Account.
- Age bar for opening of Personal FDR Account: 18 years or above. However, Minor account can be opened under the supervision of his / her / their guardian.

Term	Revised Rate of Interest
3 months	10.00%
6 months	9.75%
12 months	9.75%

### Procedure for opening of Accounts

Before opening of a current or savings account, the following formalities must be completed by the customer:

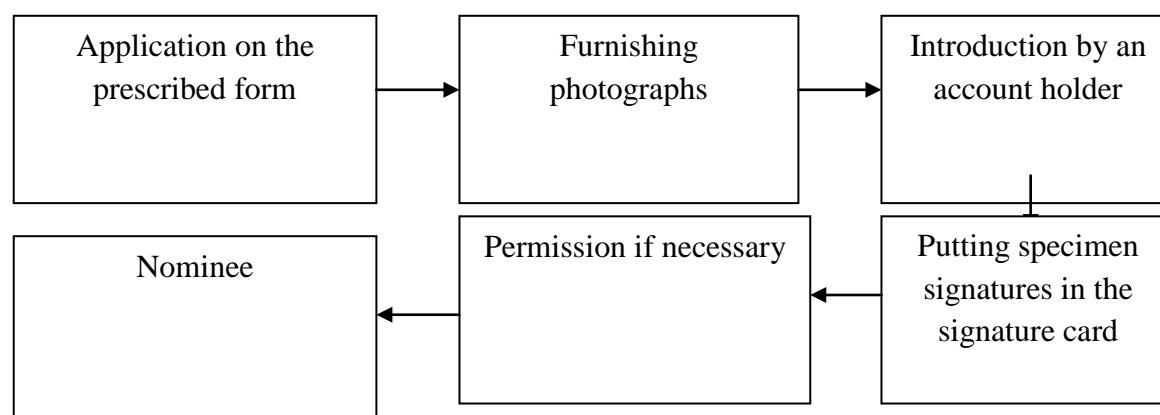

Doing the above formalities, customers submit those forms to the bank; then bank generally opens an account against the account user & provides the customer a pay-in-slip book.

### **Issuance of Cheque Book to the Customers:**

Fresh cheque book is issued to the account holder only against requisition on the prescribed requisition slip attached with the cheque book issued earlier, after proper verification of the signature of the account holder personally or to his duly authorized representative against proper acknowledgment.

### **Procedure of issuance of a cheque book:**

Enter new cheque book no. in the register book including the specific customer's name . There are some rules , both bank and account holder should follow. These are :

- A customer who opened a new a/c initially deposits minimum required money in the account. (minimum 500 tk.)
- The account opening form is sent for issuance of a cheque book
- Respected Officer first draws a cheque book
- Officer then sealed it with branch name.
- In-charge officer enters the number of the cheque Book in Cheque Issue Register including customer's name and the account number .
- Account number and name of the customer are then writing down on the face of the Cheque Book and on every leaf of the Cheque book including Requisition Slip.
- Number of Cheque book and date of issuance is also written on the application form.
- The customer is asked to sign in the Cheque book issue register.
- Then the respected Officer signs on the face of the requisition slip put his initial in the register and hand over the cheque book to the customer.

### **Closing the Account**

Bank can close an account , if the account request the bank to do so. For that, account holder has to write an application for closing the account. Then, the following procedure is followed by a banker :

- First, the customer should be asked to draw the final cheque for the amount standing to the credit of his account less the amount of closing and other incidental charges and surrender the unused cheque leaves.

- The account should be debited for the account closing charges etc. and an authorized officer of the Bank should destroy unused cheque leaves.
- In case of joint a/c, the application for closing the a/c should be signed by all the joint holders.

However , A banker can also close the account of his customer or stop the operation of the account under following considerable circumstances:

- Death of customer.
- Customer's insanity and insolvency.
- Order of the court
- Specific charge for fraud forgery.

## **Remittance:**

### **i. Demand Draft (DD):**

This is an instrument through which customers money is remitted to another person /firm /organization in outstation from a branch of one bank to another outstation branch of the same bank or to a branch of another bank (with prior arrangement between that bank with the issuing bank).

#### **Issuing procedure of D.D:**

- Obtain demand draft application form duly filled in and signed by the purchaser /applicant.
- Receive the amount in case/ transfer with prescribed commission and postage amount.
- Insert test number.
- Enter in the D.D. register.
- Issue advice to the payee branch.

#### **Payment procedure of D.D:**

- Examine generally of the D.D. viz. Amount, verify signature, test, series, etc.
- Enter in the DD payable register.
- Verify with the ICBA /test etc.
- Pass necessary vouchers.

## ii. Telephonic transfer (TT):

This is a mode of transfer / remittance of customer money from a branch of one bank to another branch of the same bank or to a branch of another bank with prior arrangement between the banks with the TT issuing branch through telephonic message. Characteristics of TT are:

- Issued by one branch to other branch and message is tele- communicated.
- Remittance / transfer of money are done through tested tele-messages.
- Remittance is affected on the basis of tested message.
- Test key apparatus required.

### TT issuing procedure

- Obtain TT application form duly filled in and signed by the purchaser/ applicant with full account particulars of the beneficiary.
- Receive the amount in cash/ transfer with prescribed commission, postage, telephone/telex etc.
- Prepare TT message inserting code number.
- Enter in TT issue register.
- Issue advice to the payee branch.

### TT payments procedure

- Note the TT message and verify the test number and confirm if TT serial no. Etc. is OK.
- If ok, enter into TT payable register.
- Pass necessary voucher for payment.
- 

## iii. Pay order (PO):

This is an instrument issued by the branch of a bank for enabling the customer/ purchaser to pay certain amount of money to the order of a certain person/ firm/ organization/ department/office within the same clearinghouse area of the pay order-issuing branch. Pay order has different characteristics:

- The issuing branch and the paying branch are same.
- Application for payment within the clearing house area of the issuing branch.

- This may be open or can be crossed.

#### **Procedure of P.O. issue:**

- Obtain PO application form duly filled in and signed by the applicant.
- Receive the amount in cash/transfer with commission amount.
- Issues pay order.
- Enter in pay order register.

#### **Procedures of pay order payments:**

- Examine genuinely of the pay order.
- Enter in to pay order register and give contra entry.
- Debit if fund ok for payment.

#### **Clearing:**

Generally speaking, clearing means settlement but from Banker's point of view it refers to the procedure of receipts & payments of proceeds of cheques and other instruments through banks.

Clearing House is a place where the representatives of all member banks meet together and settle mutual obligations of banks arising out of cheques & other instruments drawn on one bank and deposited with another bank for collection, under a special arrangement. The characteristic of the clearing house is that at the time of coming to this place the representative of every bank brings with him all cheques etc drawn on other banks along with schedules and delivers the cheques to the clearing house and receives cheques etc drawn on his bank and on the basis of cheques etc. delivered & received the mutual obligations between banks is ascertained and settled through their respective bank accounts maintained with the Central Bank or any other bank which conducts the clearing house.

#### **i. Types of Clearing:**

There are two types of Clearing. such as

- (a) Internal or Inter-branch Clearing ,
- (b) Inter-Bank Clearing.

Under the 1<sup>st</sup> type all branches of the same bank situated in a particular city settle their mutual obligations through the main branch of the bank. On the other Hand, in one city the obligations

between all banks are settled. In this case Bangladesh Bank or Sonali Bank performs the function of the Clearing House in Bangladesh.

**Kinds of Clearing:**

The Clearing House activities may be grouped into two types,

- (1) Outward clearing,
- (2) Inward Clearing.

(1) Outward Clearing Procedure:

- Receipt of instrument with paying in slip.
- Checking of instrument & paying in slip.
- Affixing of seal
- Special Crossing seal.
- Clearing Seal (Instrument & Paying in slip)
- Signing of counterfoil and returning it with seal to the depositor.
- Separation of instrument from paying in slip.
- Sorting of instrument bank wise and branch wise.
- Preparation of schedule- branch wise.
- Preparation Bank wise schedule.
- Tallying of totals of paying in slips with the totals of Clearing House sheet.
- Making of entries in Clearing Register (Outward)
- Preparation of vouchers.
- Sending of instruments to main branch with schedule.
- Collection of credit advice from Main Branch.

*ii. Inward Clearing Procedure:*

- Receipt of instruments with schedule
- Checking of instruments.
- Sending of instruments to different Departments/Sections for posting.
- Preparation of Vouchers and sending of credit advice to main branch.

**iii. Clearing Return Procedure:**

- Outward clearing Return
  - Preparation of return memo.

- Making of entry in clearing return Register.
- Preparation of schedule.
- Sending of instruments to main branch before second clear.
- Inward Clearing Return
  - Receipt of instrument with return memo.
  - Preparation of Party debit Voucher.
  - Making of entry in cheque return Register.
  - Sending of instrument with return memo and party debit advice to party by post or through peon.

### **Cash:**

In cash department ,Trainee cash officers receive cash and pay cash to the customers.

#### **i. Procedure of Cash Receipts:**

- While receiving cash the receiving cashier should see that the paying in slip has been properly filled in.
- The paying in slip does not bear the name of another branch or the customer has not mentioned the name of another branch.
- The title and number of account have been mentioned on the paying in slip and the counterfoil.
- The amount in words and figures are the same.
- The particulars and amount on the pay-in slip and the counterfoil are same.
- The Cashier should receive money, count it and mention the denomination of notes on the back of the paying in slip and see that the total tallies with the amount of the paying in slip.
- He should count the notes again and verify the amount from that mentioned on the paying in slip.
- He should enter the particulars as to the name of the party, account number and amount in the Receipt Register.
- He should sign on both the parts of the paying in slip i.e. voucher and the counterfoil.
- He should then hand over the paying in slip and the Receipt Register to the authorized person, Officer in Charge/Head Cashier.
- For the amount received on account of commission, Telegram and postal charges where no separate voucher is passed he should maintain record in a separate book or

enter the same in Receipt Register immediately. He should prepare relevant vouchers and hand over the same to the authorized person for affixing the “CASH RECEIVED” stamp and obtain counter signature from the officer.

- After the close of business hours, he should balance the cash receipts from the register, and should keep the cash ready for checking by the authorized person

## **ii. Procedure of Cash Payment:**

### **For Payment of Cheques:**

- Payment Cashier should see that the cheque is in order i.e. the amount in words and figures is same. The cheque is neither post dated nor state.
- He should then request the presenter of the cheque to sign on the back of the cheque.
- The paying cashier sees that the signature of the ledger keeper and in case of big amount cheques, the signature of the officer and the Manager are there on the cheque as a token of having posted and supervised the cheque.
- If the cheque is payable to the order of payee, the payee or the endorsee (if endorsed) has been properly identified.
- Then he should take out cash and call out the name of the party and ask him about the amount of the cheque and his token number. If the amount stated by the party differs from the amount of the cheque, he should tally the token number, if the token number is the same and the amount differs, he should report the matter to the Officer in charge/ Manager.
- He should obtain another signature of the party on the back of the cheque. He should now see that the second signature tallies with the first one already on it.
- In case the signatures do not tally, he should not make the payment and report to the Officer in charge.
- Before making the payment he should obtain the token from the party and see that the amount and token number are the same.
- He should, once again, ask the party about the amount of his cheque and count the cash for the second time before making payment. When satisfied in all respects he should make payment.
- He should affix the “CASH PAID” stamp bearing the date of payment.
- He should put his full signature under the cash paid stamp.



- He should enter the particulars of the cash payment in his payment Register.
- He should keep the cheques so paid in his safe custody till the Officer in charge/Manager checks his payment register.
- 

### **iii. Cash Payment of other instrument:**

- In case of cash payment of Drafts, Pay Orders and Pay Slips, he should see that the payee has been properly identified, and in case of Pay Slips, the beneficiary has signed on proper revenue stamp.
- The Officer/ Officers has/ have signed under the stamp “PAY CASH”
- In other respects, so far as applicable, the same procedure is to be followed as in payment of cheques.

### **iv. Procedure of Cash Handling:**

The Cashier should know to differentiate defective, Mutilated, Burnt, Torn etc. notes from good notes. As a matter of rule such notes should not be accepted over the counter as deposits or in exchange of good notes. These notes, under special circumstances, may be accepted only on “collection basis”. These notes should immediately be sent to Bangladesh Bank/ Sonali Bank for receiving payment of exchange value.

### **Others products:**

1. ATM / Debit Card : ATM card of Southeast Bank Ltd is known as “SEBL My Card”.

Features of this card, are:

- 24/7 accessibility across the country
  - Accessibility through DBBL ATM Network
  - Free for year one
  - Renewal fee is taka 500 ( five hundred ) only
  - PIN reissuance is taka 200 (two Hundred) only.
2. Virtual Card : Virtual Card will only be used for online payment on internet against the fees as under:
    - Membership Fees of Foreign Professional and Scientific Institutions

- Fees for Application, Registration, Admission, Examination (TOEFL, SAT etc.) in connection with admission into foreign educational institutions.

Product Pricing :

Card Fee : USD 10.00 as Card Fee + USD 1.50 Vat on Card Fee

Loading Fee : 1 % of the remittance amount

### **iii. Remittance Business**

Our eight million expatriates are a source of pride for Bangladesh. They represent us abroad by building our image. Their contribution is equally important, if not more, in the contribution they make to the economy of the country. The foreign exchange they send home is the second largest source of much needed foreign exchange for our economic development.

Although Southeast Bank Limited (SEBL) has entered into remittance late compared to the other private banks, it has continuously strived to build its remittance business around quality service by making it easy for remitters to remit money through a network under agreements with reputed banks and exchange houses abroad and an extensive network in the country to deliver the money to the beneficiaries at their door in the quickest possible time in safe and without hassle.

Features of our one - stop remittance delivery service are:

- No service Charge
- Confidentiality in Transaction
- Instant Account credit
- 24/7 cash payment facilities from nationwide 1000 Grameen Phone (GP) outlets
- Direct communication with both Sender and Receiver for solving cash payment / account deposit problem.

South east Bank Ltd has adequate Foreign Remittance sending arrangements in the major Bangladeshis Expatriates concentrated countries and territories over the globe through which any Bangladeshi expatriates can easily remit their money .

### **Global Partners :**

- Western Union Money Transfer Services
- Ria Financial Services

- Xpress Money Services
- MoneyGram International
- Aftab Currency Exchange

#### iv. SWIFT Services

The Society for Worldwide Inter Bank Financial Telecommunication ("SWIFT") operates a worldwide financial messaging network. Messages are securely and reliably exchanged between banks and other financial institutions. Southeast Bank Limited has SWIFT services. The Bank's SWIFT address is SEBD BD DH.

#### v. Locker Services:

**Eligibility:** A client must have a CD or STD or SB or any type of account in the respective branch where they want to avail the locker service.

#### Fees And Charges

Locker Service	Yearly Charge	Security Deposit
Small	Tk. 1,500/=	Tk.2,500/=(Refundable)
Medium	Tk. 2,500/=	Tk.2,500/=(Refundable)
Large	Tk. 4,000/=	Tk.2,500/=(Refundable)

#### vi. Internet Banking

SEBL's aim is to provide every customer easy access to his/her account from any branch. Recognizing the need of customers SEBL has networked all of its branches all over the country to permit its valued customers to carry out transactions from any branch. Cash withdrawal or deposit or any type of personal banking transactions can be performed using the any Branch office.

#### vii. Bill Collection Service

SEBL Provides following Bill collection service:

1. Dhaka WASA Bill

### **viii. Western Union Money Transfer Services**

With the signing of the Representation Agreement between Western Union Financial Services, Inc., U.S.A. and Southeast Bank Ltd., Bangladeshi Wage Earners abroad can send their money through Western Union and their families and friends can receive the money in minutes by visiting any of the branches of Southeast Bank Ltd. all over Bangladesh.

There is a 3 step process to send money through Western Union Money transfer Service, which are given below:

- First, The sender have to receive a money receipt with a Money Transfer Control Number (MTCN) from any of the Western Union agent location outside Bangladesh after depositing money.
- Then, the sender will inform the money transfer detail (amount of money sent, sender's name, receiver's name, destination country, and MTCN) to the receiver.
- The receiver will receive the money from any of the branches of Southeast Bank Ltd. by showing a valid Identification and filling a form

**Chapter-04:**  
**JOB RESPONSIBILITIES**  
**AS AN INTERN**  
**IN**  
**MOHAMMADPUR**  
**BRANCH**  
**OF**  
**SOUTHEAST BANK LTD.**

## Job Responsibilities:

Credit is the front-side banking service department. It provides those customers who come regularly. In some Credit risk management, there is no relation between banker and customers who will take only one service from bank. On the other hand, there are some customers with whom banks are doing its business frequently.

I worked mainly in the Credit department and then other department for last 3 months under senior officer Mahadi Sabiar Rahman and Tania Afrin, who are looking after the credit section. Here, first I learnt about audit where I checked regular transaction of the branch.

### Audit:

In Audit Section, we are working on 3 types of transactions. They are:

1. General ledger Transactions,
2. Customer Ledger Transactions,
3. Cash Transactions.

**1. General ledger Transactions:** In general ledger transaction area, I worked on the regular trisections which are done inside the branch and for the branch. There are four parts having Debit and Credit.

Under Code 901, I collected and organized the transactions occurred under Bank's Assets.

Under Code 902, I collected and organized the transactions occurred under Bank's Income sector.

Under Code 903, I collected and organized the transactions occurred under Bank's Liabilities.

Under Code 904, I collected and organized the transactions occurred under Bank's Expenditure sector.

**2. Customer Ledger Transactions:** In Customer ledger transaction area, I worked on the regular trisections which are happened between customer and bank/branch. There are different code number for different accounts and schemes having Debit and Credit. For example,

**Code 111 for** – Current accounts

**Code 121 for** – Savings accounts for clients and customers

**Code 122 for** - Savings accounts for Staffs

**Code 241 for** –FDR for 3 months

**Code 243 for-** FDR for 6 months

**Code 244 for-** FDR for 1 year

**3. Cash Transactions:** In cash transaction, I checked the cash transaction happened between bank and customer. We can also say that, here cash payment and collection are checked.

Bank does this auditing to check whether all transactions recorded properly or not.

### **My area of concentration:**

In my report , I decided to concentrate on the credit risk management of Southeast Bank Ltd. So that, I want to say what credit system is. Credit system is the loan system inside the branch/ bank from the money bank gets from deposits, FDR and schemes . There are 2 types of loan.

They are :

1. Time loan
2. Term Loan
3. Over Draft ( OD)

#### **1. Time Loan :**

Time loan is given for specific period of time, highest for 1 year.

#### **2. Term loan:**

In case of Term Loan , security is obtained as a line of defense to fall back upon. It is meant to be an insurance against emergency. But taking security, bank acquires a claim upon the assets of the borrower if repayment is not made as planned. But what should be the significant securities of loans depends in the guidelines prescribed by the Bangladesh Bank through BCD circular no. 17/1977 and also the negotiation of the respective branch to its borrowers. The most significant categories of security lodged are as Asset pledge for credit approval: A no. of asset can be pledged for sanctioning loan. SEBL accept the following asset for sanctioning loan

- Collateral of land & building
- Share certificate

- Local bank & financial institution guarantee
- Fixed deposit receipt
- Export documents
- FDR of other bank
- Govt. bond
- Personal guarantee
- Others securities

There are 3 types of term loan:

1. Personal Loan
2. Car loan
3. Home Loan

Product	Loan Limit	Interest Rate	Maximum Tenure	Age Limit
<b>1. Southeast Personal Loan</b>	Minimum Tk. 50000/- to Tk. 5 lac ( No collateral is required)  Above Tk. 5.0 lac  ( with cash collateral)	19%  ( 2% less for SEBL employee)	60 months  ( For SEBL Employee 72 months)	21-55 years ; retirement age or 65 years whichever is earlier covers tenor.
<b>4. Southeast Car Loan</b>	Minimum Tk. 3 lac to Tk. 20 lac with	19%  (2% less for SEBL	60 months  ( For SEBL Employee 72	21-55 years ; retirement age or 65 years whichever is earlier covers tenor.



	hypothecation of car purchased under the scheme.	employee)	months)	
<b>5. Southeast Home Loan</b>	Minimum Tk. 2.0 Lac to Tk. 75 Lac.	17% (2% less for SEBL employee)	120 months for flat purchase/ construction 48 months for house renovation.  (180 months for SEBL employee).	21-55 years ; retirement age or 65 years whichever is earlier covers tenor.

### 3. Over Draft:

Over Draft is also a kind of loan. Over Draft is mainly two types .They are:

1. Cash Back: This type is given to the individual against that customer's FDR or Schemes for highest 1 year. In every three months, interest is charged. Interest is based on scheme/FDR rate. 3% extra interest is added over the interest rate is decided on the FDR /scheme.

A customer can get highest 90% of his/her FDR's amount.

A customer can get highest 80% of his/her deposited amount of money for that scheme, because if the scheme is pre-mature on the time ,when he breaks the scheme ,then customer can only get what he deposited ,when he take the loan.

### Credit management procedure of SEBL:

The Bank has an exhaustive credit policy which is periodically reviewed and updated under which all the functions of credit operations and management are carried out. The credit policy broadly includes and provides the Bank with the guidelines on the following aspects of credit:

- The Application Process
- Analysis of credit risk
- Loan structure and terms
- Documentation / Communication
- Managing risk after loan approval
- Monitoring on-going credit risk
- Loan review function
- Loan modification
- Loan restructuring
- Problem loan identification and mitigation techniques
- Loan account closing

In addition to the above, to cater to the needs of the financing requirement in specific sectors, separate schemes like (i) Consumer Credit Scheme (ii) SME Credit Scheme (iii) Agricultural Loan Scheme (iv) Scheme for financing in Leather Sector etc. have been devised as per policy and guideline of Bangladesh Bank from time to time.

**Documents to be required to avail the loan:**

- Three copies of Passport size photographs.
- Last 3 months bank's statement
- Last pay certificate from the employer/profit/Income Statement of last 3 months for self employed persons.
- Proof of ID/Citizenship certificate from the competent authority  
e.g: Net worth statement, Quotation Certificate

- Proof of employment of minimum 2/4 years regular service as applicable in the category
- Copy of Employment Letter.
- Salary Certificate from the Employer/ authorization from the employer
- Personal Guarantee acceptable to the Bank (possessing equivalent status/Financial capacity)
- Spouse guarantee

### **Credit / Loan sanction procedure of SEBL:**

**Step 1:** After the arrival of the client, the bank tries to understand what type of loan is needed.

The bank observes his account maintaining, other transactions like L/C etc.

**Step 2:** Then the client has to fill up the CREDIT REQUEST FORM (CRF).

**Step 3:** Then the bank evaluates client's property (Present market value and Distress value).

**Step 4:** Then the bank prepares the credit proposal. Credit proposal includes the following information:

- Clients name, background & business position
- Guarantors name & business position (if any)
- Net asset
- Account turnover
- Import turnover etc.

Branch sends credit proposal, credit request form & one set of valuation form for approval of the Head Office.

**Step 5:** C.I.B. report (Credit Investigation Bureau: Bank seeks information about the client from Bangladesh Bank through the Head Office. Branch provides CIB report to head Office with the proposal.

CIB Form 1- Company profile

CIB Form 2- Owners profile

CIB Form3- Others company profile

**Step 6:** After few days branch gets approval from the Head Office.

**Step 7:** Then they collect all original copies of property documents from client and send those to the legal advisors.

**Step 8:** SEBL gets the following documents from the legal advisors:

- Deed of Mortgage [ Type the contents on 12 stamps cost 100 Taka each]
- General power of attorney to sell the mortgage property [Type on Tk.150 stamp]

**Step 9:** Registered the documents in the registry office. The bank preserves the client sign on the backside of the registry receipt.

**Step 10:** Then SEBL Savar branch fills up loan account input form.

**Step 11:** SEBL disburse loan to the client.

**Step 12:** Review the loan regularly.

### Flow Chart of approval process

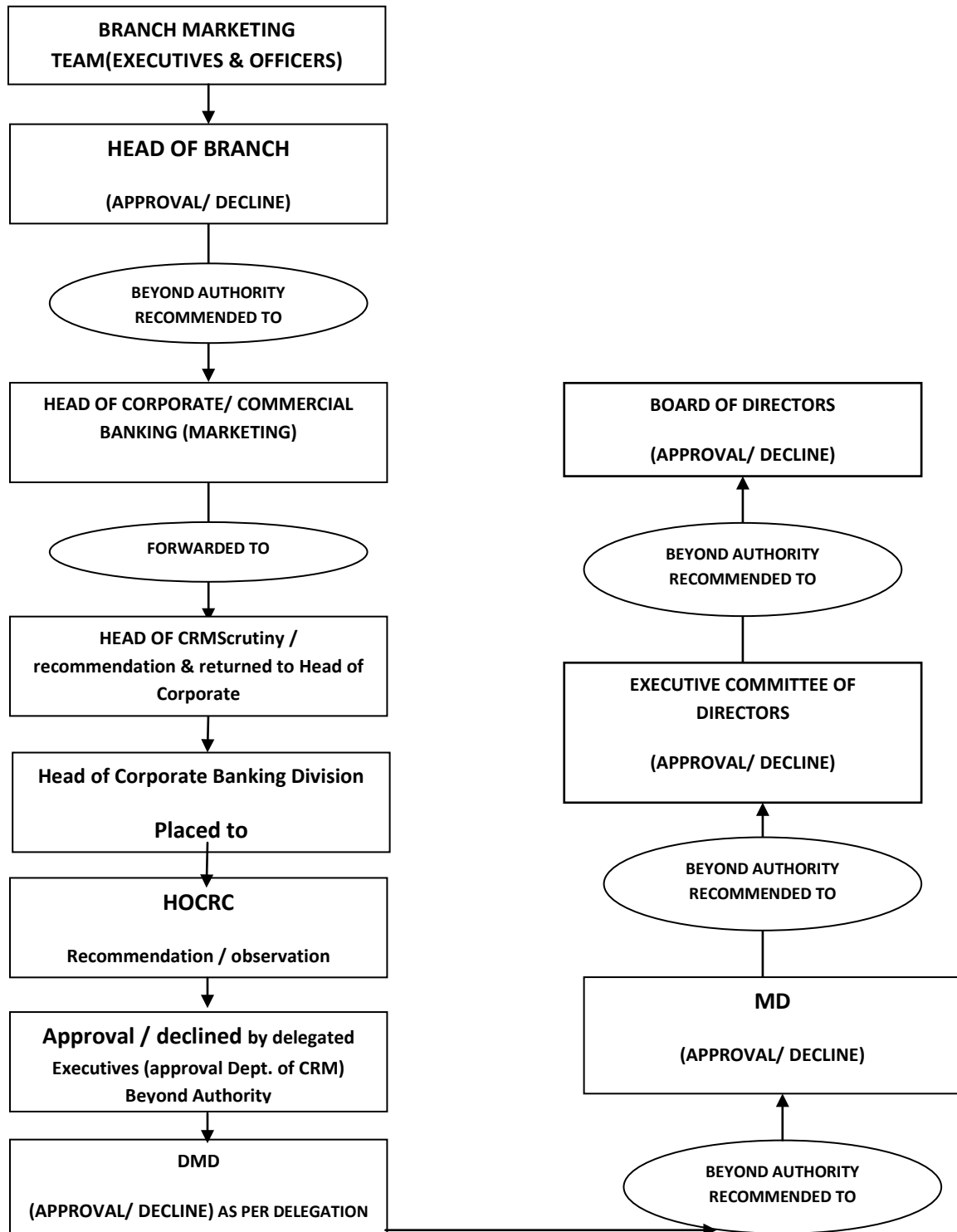

## Eligibility for obtaining credit

For the credit, different Banks have different criteria. Some bank offers this credit to each level of income group with every profession where others have some limited area for disbursement of this credit. Usually the credit is given to following employees:

- Permanent employees of Government Bodies.
- Permanent employees of Semi-Government Bodies and Autonomous bodies.
- Permanent employees of Banks, Insurance Companies and other financial institutions.
- Permanent employees of Universities, Colleges and Schools.
- Employees of Armed forces, BDR, Police and Ansar.

After that, I worked in the account opening section and here my supervisor was Shuvra Sarker (Trainee officer), who gave me an introduction on the account opening process. She also told me account opening is under SEBL General banking which is divided into 7 sections. These seven sections are:

- 1) Account opening section.
- 2) FDR.
- 3) Clearing section.
- 4) Remittance section.
- 5) Cash section.
- 6) Accounts Section.
- 7) Foreign exchange./Remittance

Now I would like to elaborate my activity which was done by me.

**Account opening section:** In account opening section, Ms. Shuvra Sarkar first introduced me with the Application Form for Current/ Savings Account. For current or saving account, I have to tell the client to fulfill the procedure by giving necessary documents. Before that, I have to ask the customer that if he/she wants to continue the account. As, he/she must accept the conditions to keep open the account like,

1. First, minimum Balance to be maintained in current account Tk 10,000.00 and for Savings account Tk. 500/- .
2. Recent photographs of the Account openers duly attested by the Introducer must be produced.
3. When cheque deposited are payable by other banks or outstation they are available after clearing or collection only, Service charge will be charged @ Tk.100 /- in Current account and Tk.50 /- in Savings account yearly or as charged by the Bank from time to time as and when required ***Interest rate for Savings Account (SB) at 5 % (Half years compounding).***

These documents are the main contents of the application form for opening Savings or Current account in SEBL:

For individual:

- 1) Name of the Applicant(s)
- 2) Father's/ husband's Name
- 3) Present Address
- 4) Permanent Address
- 5) Number, Date of issue, Date of Expiry & Place of Issue of Passport (if any)
- 6) Date of Birth
- 7) Photocopy of Voter ID Card (Both the Party and Nominee)
- 8) Occupation
- 9) Nominee (s)
- 10) Special Instruction of Operation of the Account (if any)
- 11) Initial Deposit
- 12) Specimen Signature (s) of the Applicant (s)
- 13) Introducer's Information (Name, Account Number, Specimen Signature)
- 14) Two copies of photographs of the Account Holder (s) duly attested by the Introducer
- 15) One copies of photograph of the Nominee duly attested by the Account Holder

In case of Join Account, bank needs these two contents too:

- a) Operation instruction of the account.
- b) Signature.

Then, in Partnership Account

- a) Partner's Signature.
- b) Partner's Name.

Again, In case of Minor's Account ,

1. Putting the word "MINOR" after the title of the account.
2. Recording special instruction of operation of the account.
3. The account opening form is to be filled in and signed by either of the parents or the legal guardian appointed by the Court of Law & not by the Minor.

After fulfilling the above formalities, I submit those forms to the bank; then bank generally opens an account against the account user & provides the customer a pay-in-slip book. Then Bank sends Letter of thanks to Account Holder(s) and Introducer to be sent under registered post to verify the address of the account holder.

Risk areas in Account opening are

1. Account holder's identification: If account holders provide fake national identification number (NID) or fake passport. It might be risk for bank.
2. Source of income: Legal income source must. If account holder's source of income illegal then money laundering must.

### **Work Responsibilities:**

When clients came to know about any kind of account opening like SB, CD, SND and schemes then I gave them a form and help them to fill the form with proper information. I also gave cheque book to client and took their sign to the register copy and the in charge officer verified their sign in computer is the sign is right then I let them go.

After that I worked under another supervisor, Jihan Sultana (Senior officer) in charge of FDR. She gave me a general idea about FDR.

### **FDR Opening:**

Before opening of a FDR account, the following formalities must be completed by the customer :



- Application on the prescribed form
- Furnishing photographs both a/c holder and nominee
- Introduction by an account holder
- Putting specimen signatures in the signature card
- Nominee

After fulfilling the above formalities, I submit those forms to the bank; then bank generally opens an FDR account against the account user (if the customers have any other a/c in the same bank like SB or schemes then bank provide the same user id but different a/c holding number. Like, someone open 3 months FDR then his or her FDR a/c holder number starts with 243...& same user id) & provides the customer a cheque slip.

The contents of the application form for FDR are same as account opening .

**Risk areas in Account opening:** Like,

1. Account holder's identification: If account holders provide fake national identification number (NID) or fake passport. It might be risk for bank.
2. Source of income: Legal income source must. If account holder's source of income illegal then money laundering must.

Here are actually the same risk areas like a/c opening.

**Work Responsibilities:**

When clients came to know about any kind of FDR account opening like 1, 2, 3, 6 or 12 months then I gave them a form and help them to fill the form with proper information. After that , I helped my supervisor to make ready the newly filled form to give Manager for his approval.

I worked also in clearing section and here my supervisor was TamannaYesminJitu in charge of clearing. Here my supervisor gave me a outline about clearing section and its activities..

Clearing section is an important section of general banking. This is the section through which branch has to clear it's inter branch & inter branch transaction. Customers do pay & receive the collecting branch. For example, a client from SEBL received a cheque of another bank, which is located in the clearing range deposit the cheque in his account at SEBL. Now SEBL will credit his account & collected it. Though the amount is credited in the customer's account but he will not get the money until the cheque is honored.

## **Types of Clearing:**

- Inward clearing cheque
- Outward clearing cheque.

### ➤ **Inward clearing cheque :**

When a particular branch receives a cheque for them & sent by other member bank for collections are treated as inward clearing cheque.

**For example**, if any cheque drawn on SEBL Mohammadpur Branch then the cheque from Mercantile Bank Ltd, Kawran Bazaar Branch is called inward cheque of SEBL Mohammadpur Branch.

### ➤ **Outward clearing cheque:**

Outward cheques are drawn on other bank branches which are presented on the concerned branch for collection through clearing house of Bangladesh Bank.

**For example**, the cheque drawn on Mercantile Bank Ltd, Kawran Bazaar Branch has been presented on SEBL Mohammadpur Branch. This cheque is called the outward cheque of SEBL Mohammadpur Office. Hence it is said that the cheque which is the inward cheque of one bank is the outward cheque of another bank.

## **Whenever a cheque is brought to the collection the concerned Officer does two functions**

- ✓ Giving the special crossing.
- ✓ Endorsed by the collecting bank.

In this case I conducted to check that the concerned officer did the function properly or not.

Risk areas in Clearing is fake/false cheque , for this reason it is very important to verify the genuineness of clearing cheque after collecting the cheque .

**Work Responsibilities:** After giving the special crossing I wrote down the cheque number and other details in the cheque clearing book and count the total value in two different sections.

There are two types of cheque :

1. High value cheque : five lakh taka and above
2. Regular value cheque: Below five lakh taka.

### **Organization Wide:**

#### **Monthly Savings Scheme (MSS) Account and Pension Savings Scheme (PSS) Account:**

A person having a sound mind can open the account. He or she can open more than one Monthly Savings Scheme (MSS) Account, Pension Savings Scheme (PSS) Account,

MSS account at any branch of the bank but in separate form should be filled in. The applicant must open have a SB or CD account with the branch from where monthly installment will be realized automatically.

#### **Super Double Benefit Scheme (SDBS) Account:**

A person of 18 years of age and above can open the account. SDBS account can be opened in joint names and in the name of any institution. No benefit including interest shall be allowed for pre-mature encashment within 1 year. Interest rate will be 3% higher than the scheme rate.

### **Islami Banking:**

Al - Wadiah Current Deposit (CD) Account is a transactional account where there are no restrictions. Al - Wadiah CD Account can be opened both for Individual and Corporate bodies. Al - Wadiah CD Account can be opened both for resident and non - resident Bangladeshi Nationals. Age bar for Personal Al - Wadiah CD Account: 18 years or above. Joint account can be opened. Account can be opened in the name of Trust / Club / Association / Societies / Non - Trading Concerns. There are no restrictions on number of transactions in the account. It is an easy - to - use cash account.

Mudaraba Savings Bank (SB) Account is designed for savers who want to save a small part of their income to be used in the near future and also intend to have some income on such savings. They can deposit a small amount and can withdraw whenever they desire but the total numbers of withdrawals over a period of time are limited. Joint account can be opened.

**Internet Banking:**

Internet banking is very much helpful for every client. By activating internet banking they can access their account through internet. They can check account balance inquiry, account statement view and download, account information. Clients came to us then we give a form and they fill up the information.

**Reissue of PIN:**

Sometimes clients lost their pin number so they cannot access their card. For this kind of problem SEBL give them a reissue of pin request form the customers fill up the information and we send it to the head office Card Division. My job was to write down the information (customers' name, ATM card no. etc) in specific record book.

**SEBL My Card Application:**

When clients want an atm/debit card then we gave them a card application form and told them to fill up the information and then we send it to the head office Card Division. In case of issuance of replacement Card , when sometimes card is physically damaged by excessive use or stolen. At that time, customers want a new card. In this case we give them an issue of replacement card to fill up the information then we send it to the head office Card Division.

**SEBL My Card Acknowledgement Receipt:**

When client came here for new card I gave them a acknowledgement receipt form to fill up the information and after that I verify the sign and check the balance. Then we send the acknowledgement receipt in the Card Division to activate the card.

**Remittance & its Operations:**

Remittance of funds is ancillary services of Southeast Bank Ltd. It aids to remit fund from one place to another place on behalf of its customers as well as non- customers of Bank. SEBL has its branches in the major cities of the country and therefore, it serves as one of the best mediums for remittance of funds from one place to another.

With international correspondent relationship in combination with Operation Center and branch network covering almost all provinces and cities, is fully able to process remittance orders quickly, precisely and safely with simple procedure and the most attractive fee.

### **Other Relevant Activities:**

To conclude I would like to add up that Bank also gave me tasks like

1. Scanning & photocopying papers for the bank
2. Printing papers for the bank.
3. Prepare files.

**Chapter-05:**  
**FINDINGS,**  
**LEARNINGS**  
**AND**  
**RECOMENDATION**

## **FINDINGS AND LEARNINGS:**

### **Risk areas in Account opening:**

1. Account holder's identification: If account holders provide fake national identification number (NID) or fake passport. It might be risk for bank.
2. Source of income: Legal income source must. If account holder's source of income illegal then money laundering must. Verification of source of fund is required.
3. Ensuring proper introduction before opening any account which will help to trace out the customer for any kind of mishaps due to his conducts.
4. Verifying the documents provided by the client such as NID, Passport, Driving license, Trade license, Certificate of Incorporation, Board Regulation which will protect the fraudulent activities of the client.
5. Compliance of Bangladesh Bank guideline money laundering. Proper KYC (know your customer) should be done at the time of opening of the account and subsequent follow up is required.

### **Risk areas in Clearing:**

1. To ensure that the cheque has been received for clearing in the proper beneficiaries account.
1. Proper endorsement on cheque must be ensured.
2. To verify Fake/False/Post dated cheque.

### **Risk areas in Remittance:**

1. To ensure that actual beneficiary receives the remitted amount.
2. In case of remittance through TT, TT controlling number & test code must match.
3. Verity the genuineness of remittance.

### **Others:**

**i. Lack of effective advertising and promotion:** Advertising and promotion is one of the weak point of Southeast Bank Limited, Southeast Bank Limited does not have any effective

promotional activities through advertisement, but other banks have better promotional strategy. Therefore most customers are not known about their Islamic banking branch.

**ii. Lack of Computer Knowledge:** All the organizations including banks are now mostly depends on computer but employees do not have much knowledge on computer.

**iii. Unsatisfactory software performance:**

Southeast bank use Ultimus software for performing their banking activities. But the software often hanged as because of slower upgrade of data by vender. Therefore it delays to performing banking activities at time.

## **Recommendation:**

Southeast Bank Ltd. is one of the potential banks in the banking sector in Bangladesh. The Mohammadpur branch of SEBL is a small branch. It was a wonderful experience working at Southeast Bank Limited. The employees of the bank were very helpful and nice to me. In spite it was not an easy job to find so many things during the very short period of practical orientation program. Now, I would like to present my observations and give, my opinion to improve the banking service and make their customer more satisfied

First of all, Southeast bank should make its service prompt so that people need not give more time in the banking activities and fell easy to perform all respective activities. Moreover, they have to come up with new facilities and offer which will attract more client and help to ensure their premium as well as loyal customer forever. Even, they can start again some of their old facilities (For Example. Double benefit Scheme ). For achieving these keys of success they have to ensure the working process faster with better computers and operating systems .Then , Bank can have more ATM booths in Mohammadpur 's different location. More Gifts, Discounts as well as differentiated interest rates on several loan and deposit schemes for the Premium Customers

Southeast Bank Ltd must prepare an organized set of plan regarding the advertising and promotional activities which should include billboards, media, internet advertising and sponsorship. The sales team and officers should provide periodic training on interacting and dealing with different classes of potential and existing customers.



## **Lessons Learned From The Internship Program:**

### **Implication to organization:**

- I have learnt how to open different types of accounts. Like SB, CD.
- I have learnt how to open different types of schemes.
- I have learnt how to input the name of the client, issuing date & pg no in the inward register of pc.
- How to write customer name, A/C no, deposited money in inward & outward register copy.
- I learnt how to communicate with client, how to talk and how to deal with customer.
- I learnt how to work with my colleagues in one office, how to communicate with my senior officer.
- I learnt how to maintain organization discipline.
- How to verify the sign.
- Proper use of different types of seal.
- How to issue an ATM card.
- Be confidential.

Besides this I also worked in clearing & FDR. So I have learnt some new things and introduced with some basic tasks performed by each section. Now I will spray my knowledge and experience that I gathered working at there in this part of the study.

### **Implication of University's internship program:**

- The main point I have learnt from internship is that the difference between academic knowledge and professional work.
- I learnt how to follow my supervisor instruction and his valuable suggestion.
- University helps me to improve my presentation a skill during different semester which is actually helps me a lot when I am face to face a customer in the organization.
- Co education in the university helps me to be communicative and friendly.

## SWOT Analysis

STRENGTHS	WEAKNESSES
<ul style="list-style-type: none"> <li>• Southeast Bank Limited (SEBL) is newly established Commercial Bank in the Banking Sector but it builds strong reputation in short time.</li> <li>• The Financial Condition of SEBL is very strong. It's Loan and Deposit Quality is better than most other Private Commercial Banks in Bangladesh.</li> <li>• SEBL has strong network throughout the country and provide quality services to every level of Customers</li> <li>• SEBL's Correspondents Relationship with more than 200 International and Local Banks created Global Accessibility and Relationship with People.</li> <li>• Installation and use of highly sophisticated, automated System (For example, <i>BANK ULTIMUS</i>) enables Southeast Bank Limited (SEBL) to have on time communication with all Branches reduces excessive paper-works waste of time for Valued Customer Transaction</li> <li>• ATM Cards, Credit Cards and Phone Banking of SEBL give the Customers 24-hours Banking Facilities from his/her Accounts.</li> </ul>	<ul style="list-style-type: none"> <li>• The Shortage of Manpower in every Division. During the Working Hours of the Bank, the Employees have to be fatigued and cannot provide proper attention that type of Services, which create dissatisfaction of the Customers.</li> <li>• Higher Service Charge in some areas of Banking Operations discourages the Customers for opening and maintaining Accounts with SEBL.</li> <li>• In the Deposit side SEBL is facing some problems from its Competitors. Because the Competitors are giving a Higher Interest Rate in Deposits without any reason, Because of this a lot of Depositors are leaving the Bank.</li> <li>• There is a very little practice for increasing Motivation in the Employees by the Management of Southeast Bank Limited (SEBL), which discourages them to provide the best Service to the Customers.</li> </ul>

<i>OPPORTUNITIES</i>	<i>THREATS</i>
<ul style="list-style-type: none"> <li>• The greatest Opportunity for Southeast Bank Limited (SEBL) lies in the increase of standard of living of a certain mass of the Population as well as their acceptance of the Nation of Consumer Financing and Short Term Lending</li> <li>• The Credit Facility offered by Southeast Bank Limited (SEBL) attracted Security and Status conscious Businessmen and as well as Service holders with Higher Income Group.</li> </ul>	<ul style="list-style-type: none"> <li>• The emergence of several Private and Foreign Banks within the past few years offering similar Service with less or free charge for the facilities can be a major Threat of Southeast Bank Limited .</li> <li>• The Central Bank exercise strict control over all Banking Activities in Local Banks like Southeast Bank Limited .Sometimes the restrictions impose barrier in the Normal Operations and Policies of the Bank.</li> <li>• Revival Banks easily copy the Product offering of Southeast Bank Limited. Therefore the Bank is in continuous of Product Innovation to gain Temporary Advantage over its Competitors</li> </ul>

# Chapter-06:

# CONCLUSION

## CONCLUSION

As I was an intern in the Southeast Bank Limited, Mohammadpur Branch, Dhaka for three months, I had the opportunity to work in almost all the desks of Credit Division of the Branch which helped me a lot to make the report writing easier. Also, it helps me a lot to understand and face the real life problems regarding credit management and other banking activities, which is not possible to face and understand only with the help of academic knowledge. I am very grateful to every single person of my University ,Southeast Bank Ltd and people around me who help me to complete my internship and open up a new world in front of me.

# Chapter-06:

# REFERENCE

**Reference:**

1. [http://en.wikipedia.org/wiki/Banking\\_in\\_Bangladesh](http://en.wikipedia.org/wiki/Banking_in_Bangladesh)
2. <https://www.southeastbank.com.bd/home.php>
3. <http://dspace.bracu.ac.bd/handle/10361/2486#preview>