

Performance Analysis Of A Wireless Communication Network Using MIMO System

By

Siddharth Saha

13321017

Kamrul Hasan Shajib

16210012

Archita Saha

16321011

A thesis submitted to the Department of Electrical and Electronics
Engineering in partial fulfillment of the requirements for the degree of
Bachelor of Science in Electrical & Electronics Engineering

And

Bachelor of Science in Electronics & Communication Engineering

Electrical & Electronics Engineering

Brac University

September 2021

© 2021. Brac University
All rights reserved.

Declaration

It is hereby declared that

1. The thesis submitted is our own original work while completing degree at Brac University.
2. The thesis does not contain material previously published or written by a third party, except where this is appropriately cited through full and accurate referencing.
3. The thesis does not contain material which has been accepted, or submitted, for any other degree or diploma at a university or other institution.
4. We have acknowledged all main sources of help.

Student's Full Name & Signature:

Siddharth Saha
13321017

Kamrul Hasan Shajib
16210012

Archita Saha
16321011

Approval

The thesis/project titled “Performance Analysis Of A Wireless Communication Network Using MIMO System” submitted by

1. Siddharth Saha (13321017)
2. Kamrul Hasan Shajib(16210012)
3. Archita Saha (16321011)

of Summer, 2021 has been accepted as satisfactory in partial fulfillment of the requirement for the degree of Bachelor of Science in Electrical & Electronics Engineering on 03 October 2021.

Examining Committee:

Supervisor:
(Member)

Dr.Md Belal Hossain Bhuiyan
Associate Professor, Dept. of EEE
Brac University

Co-Supervisor:
(Member)

Tasfin Mahmud
Lecturer , Dept.of EEE
Brac University

Program Coordinator:
(Member)

Dr. Abu S.M. Mohsin
Assistant Professor, Dept. of EEE
BRAC University

Departmental Head:
(Chair)

Dr. Md. Mosaddequr Rahman
Professor and Chairperson, Dept. of EEE
BRAC University

Ethics Statement

This is to certify that the thesis is the result of our study and it has not been submitted elsewhere for any other degree or diploma. We have tried to put our original work into this thesis paper with proper citations where needed.

Plagiarism is considered as crime and we have tried our best to keep our paper plagiarism free.

Signature of the candidates

Siddharth Saha, 13321017

Kamrul Hasan Shajib, 16210012

Archita Saha, 16321011

Abstract

The rate at which data transmits from source to destination is a major aspect of wireless communication networks. It is desirable to transmit data bits with no possible errors but due to channel constraints and system designing; bit error occurs thus the users cannot get the information at their desired speed. In this paper, the methods for improving bit performance of a multiple input multiple output communication system is investigated. By using space time block coding at the transmitter side of MIMO we can significantly improve bit performance by reducing inter symbol interference. Side by side the effect of maximum ratio combining at the receiver side to improve bit rate was also studied. Antennas of wireless communication systems are battery limited, so it is important to allocate power efficiently. In this regard, water filling algorithm for power allocation was investigated. Waterfilling algorithm uses Singular value decomposition method to decompose MIMO channel matrix into parallel sub channels. After knowing the noise information gain of parallel sub channel gains, power is allocated accordingly to ensure power efficiency. Later, effect of different modulation scheme on Alamouti STBC MIMO system was investigated. It was found that high order modulation schemes has a better throughput but bad bit performance than a lower order modulation schemes.

Keywords: Multiple input multiple output; space time block coding; maximum ratio combining; waterfilling algorithm; singular value decomposition; inter symbol interference.

Dedicated To Almighty

Acknowledgement

First of all, we would like to thank Almighty for giving us the opportunity to complete the thesis. Without his will and mercy towards us we would not be able to complete our thesis. We strongly believe that he was with us throughout the entire journey and he gave us the opportunity to complete the work despite of many hardship and kept us safe during this pandemic. We would also like to thank our supervisor Dr. Md. Belal Hossain Bhuiyan sir for giving us enormous support and being so helpful and kind towards us. Without his guidelines and motivation we would not be able to come this far. He gave us proper instructions, acknowledged our work and gave us proper instructions whenever needed. We would also like to thank our co- supervisor Tasfin Mahmud Sir, for being so helpful and kind towards us. He was available whenever we had any difficulties with any topic or work and sir tried his best to help us. Without his cooperation and guidelines we would not be able to finish our thesis work so smoothly and he gave his best effort for helping us.

At the end, we would like to thank each and every faculty and staff members of Electrical & Electronics Engineering department who helped us throughout our journey in Brac University, and we are grateful to everyone for giving us support and motivate us to complete our work.

Table of Contents

Declearation	2
Approval.....	3
Ethics statement.....	4
Abstract.....	5
Dedication.....	6
Acknowledgement.....	7
Table of Contents.....	8
List of Tables.....	10
List of Figures.....	11
List of Acronyms	12
Chapter 1 Introduction.....	13
1.1 Background.....	13
1.2 Space-time Codes.....	15
1.3 Space-time Blok Codes.....	16
1.4 The bit error rate.....	17
1.5 Research Objectives.....	22
Chapter 2 MIMO for BER (Bit Error Rate & Capacity)	23
2.1 Multiple input and Multiple output.....	23
2.2 Background of MIMO.....	24

2.3 SISO versus MIMO Channel Capacity.....	25
2.4 Representation of MIMO Channel.....	27
2.5 Operational Principle of a MIMO System.....	28
Chapter3: Space time block code.....	32
3.1 Alamouti Space-time Code.....	33
3.2 Performance of Alamuoti Scheme.....	37
3.3 Analysis of Space-time block code.....	38
3.4 STBC for Real Constellations.....	40
3.4.1 Two transmit and one receive antennas.....	41
3.5 Complex Constellations.....	42
3.6 STBC for Complex Constellation.....	42
3.6.1 Two transmit & Two receive antennas.....	42
3.6.2 Four transmit & One receive antennas.....	44
3.7 Performance of STBC codes.....	48
Chapter 4 Antenna diversity.....	49
4.1: Antenna Configuration with space time block coding.....	51
4.1.1 Alamouti Space-time Code.....	51
Chapter 5 Maximum Ratio Combining.....	55
5.1 System Model.....	56
Chapter 6 Channel Capacity of MIMO System.....	61

6.1 Singular Value Decomposition.....	63
6.2 Water Filling Algorithm.....	64
6.3 MIMO Waterfilling Capacity.....	65
6.4 Summary of power allocation steps.....	67
6.5 Power allocation with known channel state information.....	68
Results & Discussion.....	71
Conclusion & Future work.....	77
References.....	79
Appendix	81

List of Tables

Table 2.1: Encoding and mapping for two transmit antennas using complex signals.....	34
Table 2.2: Two transmit and one receive antenna channel coefficients.....	35
Table 2.3: Encoding and mapping STBC for two transmit antennas using real signals.....	41
Table 2.4: Two transmit and two receive antennas channel coefficients.....	43
Table 2.5: Four transmit antennas encoding and mapping using complex signals.....	45
Table 2.6: Four transmit antennas and one receive antenna channel coefficients.....	47

List of Figures

Figure 1: Principles of spatial diversity in MIMO.....	18
Figure 2: Basic model of multiple input and multiple output (MIMO).....	24
Figure 3: Channel characteristic of a 2 x 2 MIMO wireless communication system.....	27
Figure 4: A 2 x 2 MIMO system with channel characteristics.....	29
Figure 5: Alamouti space-time encoder diagram.....	33
Figure 6: Alamouti space-time system with two transmit one receive antenna.....	34
Figure 7: Alamouti space-time decoder diagram.....	36
Figure 8: Space-time block encoder diagram.....	42
Figure 9: Space-time block code system with two transmit antennas and two receive antennas.....	43
Figure 10: Space-time block code system with four transmit antennas and one receive antennas.....	46
Figure 11: Time diversity and frequency diversity.....	50
Figure 12: Space-time diversity and Space-frequency diversity.....	50
Figure 13: Examples of Different antenna configurations listed as SIMO, MISO AND MIMO.....	51
Figure 14: Alamouti encoder.....	52
Figure 15: Maximal ratio combining with one transmit antenna.....	57
Figure 16: Block Diagram of MRC.....	57
Figure 17: Power Allocation for Waterfilling Algorithm.....	65
Figure 18: BER for BPSK modulation with Alamuti STBC and MRC.....	72
Figure 19: Avg Capacity of MIMO system for different num of tx-rx antennas.....	73
Figure 20: CDF of the Capacity at SNR=5dB.....	74

Figure 21 : normalized pdf of svd values for $n_{Tx}=4, n_{Rx}=4$75

Figure 22: BER performance of MIMO Alamuti in different modulation Schemes.....76

List of Acronyms

MIMO	Multiple input multiple output
SISO	Single input single output
SIMO	Single input multiple output
STC	Space time codes
STBC	Space time block codes
SVD	Singular value decomposition
CDF	Cumulative distribution function
PDF	Probability density function
MRC	Maximum ratio combining
OFDM	Orthogonal Frequency Division Multiplexing

Chapter 1

Introduction

1.1 Background

Technology is now wireless, and communication is the most important thing for any user of this era. Doing research, publishing new things, staying connected through social Medias, playing online games, sharing experiences and many other things depends on the capacity of the network a person is using. From last few years with the revolution of smart phones and 3G, 4G, 5G networks, the demand for capacity in wireless local area networks, home or office WIFI networks and also the mobile data has increased in an explosive manner. Users are getting a good amount of network because a huge amount of data rates is available by today's technology. Though the data rates and capacity are much more than before but at the same time these features are making progress in the user number also. Day by day user number is increasing in every network system, social media platforms and craze of online gaming is at the peak now a days. Technologically advanced system with multiple transmit antennas and receive antennas can increase the capacity and data rates in this modern time.

Many research and work on wireless communications introduced many new systems, formulas, ways to increase the data rate and capacity of a system or network. Most of those were discussed about having an antenna array at only one end of the system. Throughout many research it has been discovered that a good amount of performance gain of receive diversity can be achieved by the multiple antennas if it is used at the transmitter to gain transmit diversity. Which also has many other benefits. Techniques of transmit diversity was started in early 1990's. From then the interest in this topic has always been increasing. We can easily say that multiple-input multiple-output or MIMO technology is the foundation of many wireless communication systems. The reason behind this is the increment of data rate and capacity with this technology.

MIMO is currently a very common name in wireless network system and the current theme for much research. It is also believed that this technology will grow with the time and many new paths will be unlocked with it.

Our present system works with a single antenna on the mobile device and multiple antennas at the base station. Because implementing a second antenna on the mobile device is costly because of the mobile radio frequency components. So, this setup reduces the cost of mobile radio frequency components. Researchers believe that multiple antenna technique will be more popular with the advancement of technology.

Multiple antenna technology is not only limited for entertainment purpose but also being used in the commercial areas. Such as the first commercial wireless system was developed by the “Iospan Wireless Inc” in 2001, which uses MIMO-OFDMA technology. For this system both diversity coding and spatial multiplexing were supported by the Iospan technology. Again, IEEE 802.11n system based on MIMO was developed by Airgo Networks in 2005. Following that, MIMO is also planned to be used in mobile radio telephone standards for upcoming new generation networks such as 5G for the better data rates and capacity [1]. More to add many big companies like Samsung, Runcom Technologies, Beceem Communications has also developed solutions for IEEE 802.16 WiMAX broadband fixed and mobile standards which are based on multiple antenna technology. Simply, WiMAX gets a significant increase in spectral efficiency, better reach and rate of transmission for multiple antenna technology.

1.2 Space-time Codes:

STC or Space -Time Code is a method used widely in wireless communication systems by using multiple antennas to improve the reliability of data transmission [1]. STCs work by sending several, redundant copies of a data stream to the receiver in the hopes that at least some of them will survive the physical journey between transmission and reception in good enough condition to allow reliable decoding. There are three different types of STC's and among them space-time trellis codes (STTCs) work by distributing Trellis code over multiple antennas and time slots. Both coding and diversity gains are always provided by STTCs. Symbols are encoded according to the antennas through which they are simultaneously transmitted and decoded using maximum likelihood detection which a scheme is proposed by Tarokh [9]. Though this scheme provides sufficient performance gain and is effective enough as it combines the benefits of Forward Error Correction (FECs), it requires a good compromise between constellation size, data rate, diversity advantage, and Trellis complexity. The second type of STC which is mainly introduced as binary error-correcting Codes or called space time turbo codes (STTuC's) which is the combination of both turbo coding and space-time coding. Constructed by concatenating two recursive systematic convolution codes in parallel using the turbo decoding technique, which is a sub-optimal but extremely strong iterative decoding process. Many detections and decoding difficulties, including as serial concatenation, equalization, coded modulation, multi-user detection, joint interference suppression, and decoding, have been effectively implemented using the turbo concept.

The third and most popular type of STC is Space time Block Coding (STBC) which is less complex. STBC provides diversity gains only which makes it less complex in implementation.

1.3 Space-time Block Codes:

The Alamouti scheme is a generalized variant of space-time block coding (STBC) and thus the key features of both schemes are the same. These codes are orthogonal, allowing for full transmit diversity based on the number of transmit antennas. In other words, space-time block codes are a more complex variant of Alamouti's space-time code in, with the same encoding and decoding algorithms on both the transmitter and receiver sides as the Alamouti space-time code [6].

The information is organized as a matrix with rows equaling the number of transmit antennas and columns equaling the number of time slots required to transmit the data. When signals are received at the receiver, they are merged before being forwarded to the maximum likelihood detector, where the decision rules are implemented.

Under the limitation of having a simple linear decoding algorithm, space-time block codes were designed to obtain the maximum diversity order for the given number of transmit and receive antennas [4]. As a result, space-time block codes have become the most popular and commonly utilized method.

When channel estimation is required, space-time block codes and many other space-time algorithms, including STTCs, are designed for coherent detection.

There is a considerable literature addressing the channel estimation issue for multiple-input multiple-output (MIMO) systems, ranging from traditional training-based strategies that rely on pilot symbols to advanced techniques that use a combination of training and pilot symbols in the data stream to blind estimate, which does not require pilot sequences, and semi-blind estimation, in which data and pilot observations are combined. Non-coherent detection techniques based on differential encoding that do not require channel state information (CSI) have been considered by other authors. Despite the fact that these approaches do not require channel estimation, they frequently suffer from issues such as error propagation.

The performance of channel estimation at the receiver appears to be extremely good when using training-based methods. When obtaining an accurate and stable MIMO channel, pure training-based techniques can be regarded a benefit. However, when bandwidth efficiency is necessary, this could be a disadvantage. This is because pure training-based schemes employ a long training sequence, which is required to produce a solid MIMO channel estimate, which reduces bandwidth efficiency significantly[12].

Many wireless communication systems still use pilot sequences to estimate channel characteristics at the receiver side due to the computational difficulty of blind and semi-blind approaches

1.4 The Bit Error Rate

The bit error rate (BER) is a very common term in wireless communication system which means the number of bit errors per unit time. The cause of this effect can be the transmission channel noise, interference, distortion, bit synchronization problems, attenuation, wireless multipath fading, etc [5]. Many changes also happen due to different combinations or different uses of methods. From our previous chapters we can find out many ways and methods which was to improve the system ability but on the same time few interferences might makes some errors in the result. We have mainly used space-time block coded systems because they have the ability provide a full diversity in a wireless communication system. This ability depends on the number of transmit antenna, receive antennas and with simple maximum likelihood decoding. For the receiver to use the space time decoding algorithm CSI or channel state information is a must needed value which needs to be updated based on channel variations. We know, when it is about increasing the quality of data transmission of a wireless network than space time codes are very much powerful in this sector. Either it is SISO, or MIMO space time codes performs better for data transmission. This performance can be calculated by simulation that which one is better, and which one is not but these simulations are very much time consuming. Every researcher's target is to introduce a new system or a product or bring a solution of something with the minimum amount of

time. In order to save time consumption and to get more details about the error behavior, it is necessary to introduce an analytic expression to estimate the Bit Error Ratio (BER) performance. We know that STBC with MIMO technology has a good data transmission rate with much diversity and also better performance against the multipath interference. MIMO technology is a strategy for Digital Communication. In this area of technology this system breaks a huge transmission capacity and makes little subcarriers utilizing the Inverse Fast Fourier Transform (IFFT). We have discussed through the paper that, what are the advantages of MIMO system and the output of it. We know there are three specialized points of a MIMO system and those are Beamforming, Spatial Diversity, and spatial multiplexing. For the MIMO system space-time code is known for achieving high diversity gain and it reduces the probability of symbol error which is created by channel fading and noise. These channels fading and noise occurs due to the coding of the data stream, hence it is possible to improve data transmission rate spectral efficiency with the help of higher order modulation, but the condition is that the modulation will have to occur under the same security of connections shown in Figure 5.1,

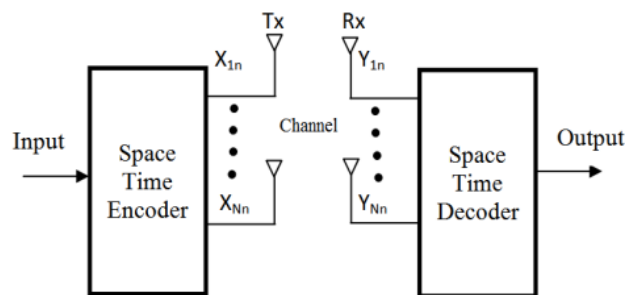

Figure 1: Principles of spatial diversity in MIMO

As the number of transmit antennas and receive antennas are increasing the channel capacity is increasing as well. Hence, there is a problem with this system and that is the Bit error rate. As the number of transmit antenna and receive antennas increases the bit error rate also increases in the system. There are many methods in this era to solve this problem and reduce the bit error rate in the system. As we have researched about STBC and Alamouti scheme previously we will compare the performance of STBC on Rayleigh fading channels. We will assume that the channel state information is known

to the receivers. STBCs with different numbers of transmit and receive antennas will be tested for bit-error-rate (BER). We will be using BPSK modulation with two transmit antennas and two receive antennas. We will assume that transmission rate is always one for STBC with real modulation methods.

Different types of modulation schemes are used in order to reduce BER problem. One of the most popular form of reducing BER is using OFDM. Although OFDM provides a high data rate, it suffers from a high Bit Error Rate and a high Peak-to-Average Power Ratio (PAPR). Because of its full transmission diversity and higher capacity, the space frequency block coded OFDM system (SFBC-OFDM) has solved the disadvantage of high BER. However, a high Peak to Average Power Ratio (PAPR) in an OFDM or SFBC OFDM system amplifies signals nonlinearly, lowering system performance in terms of bit error rate (BER). To overcome high PAPR, a variety of PAPR lowering strategies are available. However, by paying a cost bit error rate, these PAPR reduction techniques reduce PAPR.[1]

Another way of BER reduction method is to use Adaptive Channel Equalization. An adaptive equalizer is one that automatically adjusts to the communication channel's time-varying features. It is widely employed with coherent modulations like phase-shift keying to combat multipath propagation and Doppler spreading. [2]

Due to the high summation when expressing BER as a function of the equalizer coefficients, straight minimization of BER with regard to the equalizer coefficients is of exponential complexity.

The popular minimum mean-squared-error (MMSE) linear equalizer closely approximates the ideal linear equalizer that directly minimizes bit-error rate if the number of equalizer coefficients is sufficient (BER). In some instances, the minimum-BER equalization can outperform the MMSE equalizer by as much as 16 dB when the number of equalizer coefficients is insufficient to approximate the channel inverse.

Another way is the Zero forcing equalization. The Zero Forcing Equalizer is a type of linear equalization technique used in communication systems that uses the inverse of the channel's frequency response. The inverse of the channel frequency response is

applied by the Zero-Forcing Equalizer to the received signal, to re-establish the transmission once it has been disrupted channel.

In most cases, zero-forcing equalization does not function for the following reasons: First is, despite the fact that the channel impulse response has a finite duration, the equalizer's impulse response should be Infinite length. Secondly at certain frequencies, the received signal is distorted. It's possible that the signal is weak. To make up for it, the magnitude of the gain of the zero-forcing filter ("gain") increases dramatically. As a result, any noise added after the channel is amplified. The overall is enhanced by a big factor and destroys the overall signal-to-noise ratio. In addition, the channel may have its frequency response has zeroes that can't be inverted at all (Gain * 0 is still 0).

For the purpose of plotting and comparing the performance of space time block code with both channel estimation schemes are recorded when comparing with space time block code with known channel parameters at the receiver side. For the real modulation we will discuss the STBC with only two transmit antennas and one receive antenna.

From the simulated graph we can see that channel estimation scheme performance better by at least 1 dB. For different modulation methods for all space time block code cases with all different transmit and receive antenna combinations it is true. Because it estimates the channel parameters where it is using pilot sequence. By using it detect the user data. Then this detected user data again used to detect the channel parameter This process continues until all user data are detected by the scheme. After the estimation all the parameters were detected with the minimum square error that means the bit error rate was reduced by the BPSK modulation with STBC.

The performance of STBC, Orthogonal-STBC, in terms of bit error rate (BER) performance is examined now in this paper. The first family just has to know the channel on reception (Rx-CSI), but the transmitter does not. We'll look at a variety of schemes that use the space-time block codes (STBC) idea, the most well-known of which is the Alamouti code for two transmitting antennas. Alamouti's code is based on a series of transmissions spread out over two symbol periods and two antennas, and it appears in both spatial and temporal dimensions. Complex symbols produced from modulation are used to send the signals (conjugate or opposite).The code is defined by –

$$C_2 = \begin{pmatrix} s_1 & -s_2^* \\ s_2 & s_1^* \end{pmatrix}$$

Where s_1 and s_2 are the symbols to be transmitted. This code has the particularity of being orthogonal.

The data rate of a MIMO system can be increased by employing spatial multiplexing, while the reliability can be increased by using space time coding (STC). In MIMO systems, Space Time Block Codes (STBCs) are used to increase diversity or coding gain by coding across many antennas across several symbol lengths. Diversity gain, also known as power ratio, is the increase in signal-to-interference ratio caused by a diversity scheme, or how much transmission power may be reduced without sacrificing performance when a diversity scheme is used.

The difference in signal-to-noise ratio (SNR) levels between the uncoded and coded systems necessary to achieve the same bit error rate (BER) levels when employed with an error correcting code is referred to as coding gain.

STBC was first studied, and then it was modified using the Maximum Likelihood (ML) approach. Because each antenna element in a MIMO system operates on the same frequency, it requires no additional bandwidth and uses less power than a single antenna. Beamforming, spatial variety, and spatial multiplexing are three advantages of MIMO systems. Because of its straightforward implementation employing numerous antenna at the transmitter end, transmit diversity has been extensively explored for fighting fading channels. With the delay diversity technique proposed by, the first bandwidth efficient transmit diversity scheme was proposed, which was subsequently refined by giving multilayered space time architecture. For two transmit and one receive antennas, Alamuti introduced the well-known STBC. STBC is made up of data that has been space and time tagged to increase transmission reliability.

1.5 Research Objectives:

The aim of this research is to find out the Problems of connecting many devices on a single network. Improving channel capacity with MIMO system and their Channel estimation. Different implementations of space-time block codes using different numbers of transmit and receive antennas and evaluate the performances of space-time block codes using BPSK. Again, as we have talked about using multiple antenna technology that is why we will look at how increasing the number of transmit or receive antennas can improve the network capacity. If capacity is increased, then what kind of advantage and disadvantage may occur due to the changes.

Chapter 2

MIMO for BER (Bit Error Rate & Capacity):

2.1 Multiple input and multiple output:

MIMO means multiple input and multiple output. Which is a very common name in the area of network and wireless communication. It has drawn the focus as they have the ability to provide both channel capacity gain and diversity gain in a scattering environment. The demand of high bit rate has increased in recent wireless communication networks and so for it the demand of MIMO has also increased. Theories and many published papers showed and proven that the Multiple Input Multiple Output (MIMO) technology can improve both channel capacity gain and diversity gain in a scattering environment. MIMO systems can be defined as the use of multiple antennas at both the transmitting (Tx) and receiving (Rx) ends of a wireless communication network. This method is able to take advantage of multipath transmission path. To increase the data rate many methods have been applied by the engineers and researchers, but the capacity was never enough for the consumers. Things which involve a high data rate such as streaming live programs, playing more online games (high-definition game like PUBG and Free fire) and streaming an online movie. Most of the companies tries to provide Internet with a high data rate wirelessly so they can be able to attract more customers to buy their product (Internet line/Sim). Due to limited bandwidth in space, it is costly to increase the data rate. For this problem MIMO technology will be of great benefit for the companies to provide high data rate Internet

services to their customers. Now a days, cellular data systems, such as the 4G (5G will be available soon) cellular system, satellite communication systems and live footage broadcasting systems have experienced a great increase in capacity in the implementation of MIMO channel technology [7]. Home and office wireless local area networks (WLAN) routers have also been modified using MIMO technology. The main goal of this project is to explain the use of MIMO channel technology in the BER (Bit Error Rate) performance and channel capacity.

2.2 Background of Multiple Input Multiple Output:

The main purpose of multiple input multiple output technology is to increase the capacity in the wireless communication network system. This technology gained popularity right after it has implemented in the wireless networks such as broadband wireless access systems, wireless local area networks (WLAN), data networks etc. Multiple antennas means more than one antenna on both sides of transmitter and receiver side (Tx1,Tx2.....Txn and Rx1,Rx2.....Rxn) .

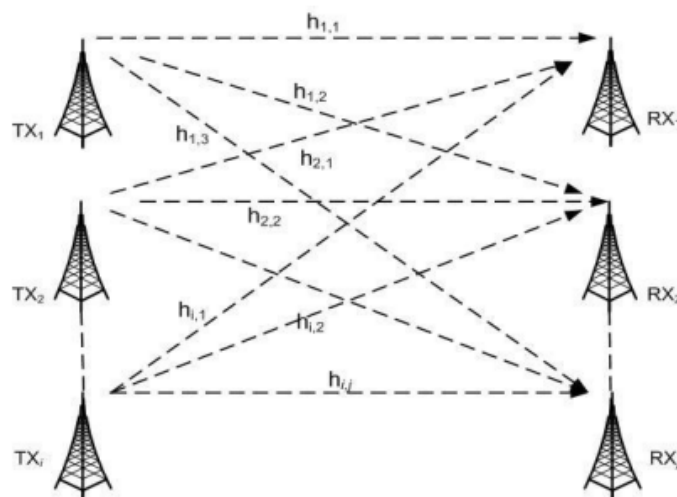

Figure 2: Basic model of multiple input and multiple output (MIMO)

The basic idea of MIMO system is that the sampled signals in the network at both the transmitter and receiver end will be combined so that they form effective multiple parallel spatial data streams which increase the data rate. This effect of diversity also improves the quality that is the bit-error rate (BER) of the communication.

Now we will discuss some of the ideas and methods how to use MIMO in the wireless networks.

2.3 Single Input Single Output (SISO) versus MIMO channel capacity

MIMO basically has the use to achieve the increase of capacity, and this means that the measurement of how much information can be transmit and receive with minimum probability of error. Single Input Single Output (SISO) system means the use of one antenna both at the transmitter (tx) and receiver (rx) end. “Claude Shannon” in 1948 discovered some limits which are for reliable transmission of information, where the limits show that is not possible to have reliable transmission of information with given transmission bandwidth and power. These limiting factors are the finite bandwidth and the S/N (Signal to noise ratio) of the channel. This is because for a communication channel to allow the signal spectrum, enough transmission bandwidth is needed otherwise there will be distortion [8]. “The higher data rate is to be transmitted, the shorter digital pulses must be used, and the shorter digital pulses are used for transmission, the wider bandwidth is required” [12]. That means we must use wider bandwidth if we want to get high data transmission rate. In this portion we can use the Shanon’s proven theory that information with a rate of r bits per second (bps) can be transmitted with a small error probability provided that the bit rate is less than the capacity of the channel $r < C$. Where C is the maximum capacity of the channel. A simple formula from Shanon can be applied here to determine the maximum capacity.

$$C = B \log_2 [1 + S/N] \text{ [(bits/s)/Hz]} \quad (1.1)$$

where S/N is the signal-to-noise ratio and B is the bandwidth of the transmission channel.

This equation informs us that how power and bandwidth are related to each other. Let's assume that we have a channel with additive noise 'N' and that we have some freedom to choose the average transmission power 'S', to set up a reliable transmission link to send 'r' bits per second. From the Shannon theorem we learn that the data rate 'r' cannot exceed capacity C and where $r < C$ as in the, but we still have one freedom in the choice of bandwidth B and power S. We can realize that for a given signal-to-noise ratio S/N, if we wish to double C, we have to double the bandwidth B. On the other hand, if we double C, for a given B we have to evaluate the S/N.

The main importance we can find of a MIMO channel technique is to improve the capacity of the channel and therefore it is important to compare the capacity of a SISO system to MIMO system. Without comparing these two systems we will not be able to find out the exact method of increasing the capacity of network. In SISO system, the Shannon formula in equation can be applied to determine the capacity of the system. However, for a comparison, it is important that the MIMO system is transmitting with a power the same as that of a SISO system. Therefore, if the power radiated by a SISO system is P_s (SNR), then the power radiated from each antenna of a MIMO system with NTX transmit antennas must be P_s/N . As MIMO has the multiple antenna system within which delivers more power than the SISO as it has only one antenna system. Now, for a MIMO system with N number of transmit antennas and M number of receive antennas the capacity of the system can be determined with the formula,

$$C = B \log_2 \left[\det \left(\mathbf{I}_M + \frac{P_s}{N} \mathbf{H} \mathbf{H}^* \right) \right] \text{ bps} \quad (1.2)$$

Where (*) means transpose-conjugate of H and H is the M x N channel matrix. \mathbf{I}_M indicates the identity matrix of dimension N x M, in this case $M = N = 2$ or more.

The interference averages of this equation to zero as signals transmitted over MIMO channel have to be linearly independent and orthogonal. From the equation we can see that that if the signal power P_s and the noise level N are the same then the more multiple antennas are used at the receiver, the more power is collected increasing the channel capacity and bandwidth.

2.4 Representation of MIMO channel

In this paper we will consider a 2 x 2 MIMO system. Which is a system with 2 transmits (Tx) and 2 receive (Rx) antennas where different and independent data streams are transmitted from multiple antennas to multiple receive antennas. This channel model can be extended to a 3 x 3 MIMO system and even more with different combinations to see the channel characteristics as the antenna numbers are changed in the transmit and receiver side. In this project the signals will be considered are baseband signals which will ignore modulation processes and concentrating on the up and down frequency conversion. For which, the signals on the i th transmit antenna will be denoted x_i while the received signal on the j -th receive antenna denoted as y_j . Figure 2 shows the antenna set-up and the various unknown channel coefficients.

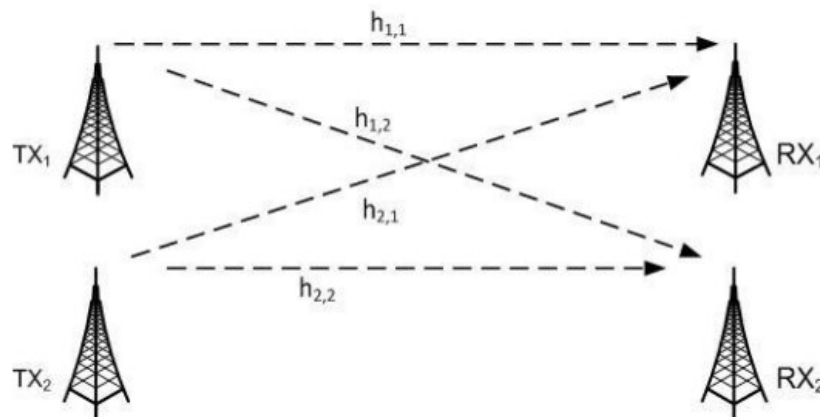

Figure 3: Channel characteristic of a 2 x 2 MIMO wireless communication system.

Let's assume the coefficient of the unknown in the channel matrix is W_c and the number of transmitted signals is X which is equal to the number of received signal Y as 2 x 2 MIMO has same number of antennas. The equation can be solved if the channel W_c is inverted which in this case a 2 x 2 matrix inversion.

2.5 Operational principles of a MIMO system

To determine channel parameters, the MIMO system sends out predetermined and well-known training signals on a regular basis from all transmitters in the system, which are received at the receiver. Depending on the received signals, the receiver calculates the characteristics of all channel paths from each transmitted antenna to each receiving antenna. If we want to prove that MIMO work, the transmitted signal X has to be solved from the group of equations,

$$Y = X W_c;$$

Where X is represented as the transmitted signals, Y is the received signal and W_c channel characteristics matrix.

Let's assume that the channel matrix has N rows as many as there are transmitting antennas with index i . Then transmitted signal vector is written as $X = (x_1, x_2, \dots, x_N)$. Also, if the channel matrix has M columns, as there are receiving antennas with index j . Then the received signal vector is $Y = (y_1, y_2, \dots, y_M)$. These vectors are extended later to matrixes by inserting K samples into each column. The channel matrix contains path characteristics as,

$$W_c = \begin{pmatrix} h_{1,1} & h_{1,2} & \dots & h_{1,M} \\ h_{2,1} & h_{2,2} & \dots & h_{2,M} \\ \vdots & \vdots & \ddots & \vdots \\ h_{N,1} & h_{N,2} & \dots & h_{N,M} \end{pmatrix} \quad (1.3)$$

This equation explains how independent transmitted signals can be transmitted from multiple transmitting antennas to multiple receiving antennas when channel characteristics are known. We should be able to calculate for transmitted signals if the received signal and the channel matrix are known.

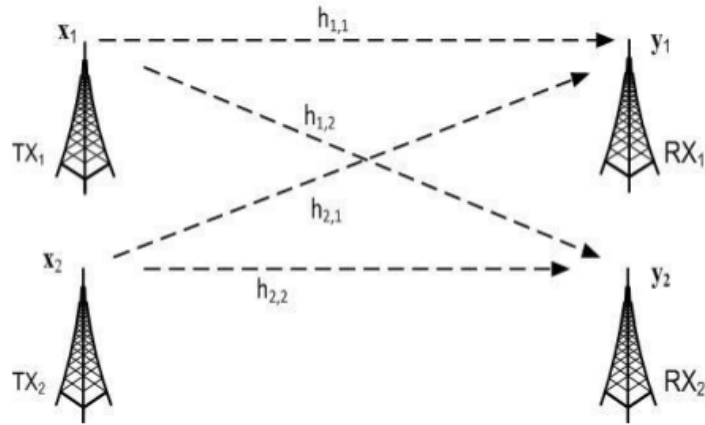

Figure 4: A 2 x 2 MIMO system with channel characteristics.

Let's consider a MIMO system according to the above figure which has $M = N = 2$ value. We will assume that the received signals and channels are known, now we will need to solve the transmitted signal. The channel matrix we have considered has N (rows) by M (columns) matrix. Again, the first index of every matrix element stands for row which is the transmitting antenna and the second for column receiving antenna.

Now, if $X = (x_1, x_2)$, $Y = (y_1, y_2)$ and $W = \begin{pmatrix} h_{1,1} & h_{1,2} \\ h_{2,1} & h_{2,2} \end{pmatrix}$ then Figure 1.3 represents a 2 x 2 MIMO system with transmitted signals, received signals and the channel characteristics.

If, $Y = X W$ then,

$$(y_1, y_2) = (x_1, x_2) \times \begin{pmatrix} h_{1,1} & h_{1,2} \\ h_{2,1} & h_{2,2} \end{pmatrix} \quad (1.4)$$

After concluding the solution of X from equation (1.4) as,

$$\begin{aligned} y_1 &= x_1 h_{1,1} + x_2 h_{2,1} \\ y_2 &= x_1 h_{1,2} + x_2 h_{2,2} \end{aligned} \quad (1.5) \text{ and } (1.6)$$

This implies that from equation (1.5),

$$\mathbf{x}_2 = \frac{\mathbf{y}_1 - \mathbf{x}_1 h_{1,1}}{h_{2,1}} \quad (1.7)$$

Substituting equation (1.7) into equation (1.6) we get,

$$\begin{aligned} \mathbf{y}_2 &= \mathbf{x}_1 h_{1,2} + \left(\frac{\mathbf{y}_1 - \mathbf{x}_1 h_{1,1}}{h_{2,1}} \right) h_{2,2} \\ \mathbf{y}_2 &= \mathbf{x}_1 h_{1,2} + \frac{h_{2,2}}{h_{2,1}} (\mathbf{y}_1 - \mathbf{x}_1 h_{1,1}) = \frac{h_{2,2}}{h_{2,1}} \mathbf{y}_1 + \left(h_{1,2} - \frac{h_{1,1} h_{2,2}}{h_{2,1}} \right) \mathbf{x}_1 \\ \mathbf{x}_1 &= \frac{\mathbf{y}_2 - \frac{h_{2,2}}{h_{2,1}} \mathbf{y}_1}{h_{1,2} - \frac{h_{1,1} h_{2,2}}{h_{2,1}}} = \frac{\mathbf{y}_2 h_{2,1} - h_{2,2} \mathbf{y}_1}{h_{1,2} h_{2,1} - h_{1,1} h_{2,2}} \\ \mathbf{x}_1 &= \frac{\mathbf{y}_2 h_{2,1} - h_{2,2} \mathbf{y}_1}{h_{2,1}} \times \frac{h_{2,1}}{h_{1,2} h_{2,1} - h_{1,1} h_{2,2}} \\ \mathbf{x}_1 &= \frac{\mathbf{y}_2 h_{2,1} - \mathbf{y}_1 h_{2,2}}{h_{1,2} h_{2,1} - h_{1,1} h_{2,2}} \end{aligned} \quad (1.8)$$

If we apply the same process, from equation (1.5) then the second transmitted signal can be calculated as,

$$\begin{aligned}
\mathbf{x}_1 &= \frac{\mathbf{y}_1 - \mathbf{x}_2 h_{2,1}}{h_{1,1}} \\
\mathbf{y}_2 &= \frac{h_{1,2}}{h_{1,1}} (\mathbf{y}_1 - \mathbf{x}_1 h_{2,1}) + \mathbf{x}_2 h_{2,2} \\
\mathbf{y}_2 &= \frac{h_{1,2}}{h_{1,1}} \mathbf{y}_1 - \frac{h_{2,1} h_{1,2}}{h_{1,1}} \mathbf{x}_2 + \mathbf{x}_2 h_{2,2} = \frac{h_{1,2}}{h_{1,1}} \mathbf{y}_1 + \left(h_{2,2} - \frac{h_{2,1} h_{1,2}}{h_{1,1}} \right) \mathbf{x}_2 \\
\mathbf{x}_2 &= \frac{\mathbf{y}_2 - \frac{h_{1,2}}{h_{1,1}} \mathbf{y}_1}{h_{2,2} - \frac{h_{2,1} h_{1,2}}{h_{1,1}}} = \frac{\frac{\mathbf{y}_2 h_{1,1} - h_{1,2} \mathbf{y}_1}{h_{1,1}}}{\frac{h_{2,2} h_{1,1} - h_{2,1} h_{1,2}}{h_{1,1}}} \\
\mathbf{x}_2 &= \frac{\mathbf{y}_2 h_{1,1} - h_{1,2} \mathbf{y}_1}{h_{1,1}} \times \frac{h_{1,1}}{h_{2,2} h_{1,1} - h_{2,1} h_{1,2}} \\
\mathbf{x}_2 &= \frac{\mathbf{y}_2 h_{1,1} - \mathbf{y}_1 h_{1,2}}{h_{2,2} h_{1,1} - h_{2,1} h_{1,2}}
\end{aligned}$$

Therefore, the solution for the transmitted signal \mathbf{X} from equation (1.4) is given in a vector form as,

$$\mathbf{X} = \left(\frac{\mathbf{y}_2 h_{2,1} - \mathbf{y}_1 h_{2,2}}{h_{1,1} h_{2,2} - h_{2,1} h_{1,2}}, \frac{\mathbf{y}_2 h_{1,1} - \mathbf{y}_1 h_{1,2}}{h_{1,1} h_{2,2} - h_{2,1} h_{1,2}} \right) \quad (1.9)$$

From the example it can be seen that with the known values of the channel characteristics \mathbf{W}_c and the received signal \mathbf{Y} , the transmitted signal \mathbf{X} can be calculated.

From the equation we can say that, with group of equations and with the help of the matrix representation it is possible to solve the transmitted signals. So, it can be proven that the transmitted signals can be determined if the channel matrix and received signals are known. This explains that MIMO works.

Chapter 3

Space–time block coding:

Space–time block coding is a technique used in wireless communications to transmit multiple copies of a data stream across several antennas and to exploit the various received versions of the data to improve the reliability of data transfer [1]. These techniques are already part of the LTE standard. Day by day demand for high speed and reliable communications are increasing. STBC with MIMO in multi-use are promising candidate in order to fulfill this demand of many users. STBC is a generalized version of Alamouti scheme. The key features or the pathway of both schemes are the same. As a result, these codes are orthogonal and may achieve full transmit diversity when the number of send antennas is specified. We can also say that space-time block codes are a complex version of Alamouti's space-time code where the encoding and decoding schemes are the same as there in the Alamouti space-time code in both the transmitter (Tx) and receiver (Rx) sides. The signals from the transmit and receive antennas uses mostly two channel paths which are multiple access channel (MAC) and broadcast channel (BC). MAC is possibly known as uplink where mobile users transmit to a base station. Again, looking at the broadcast channel which is known as downlink transmit to the mobile users. All this thing or the system of sending and receiving the signal or information's can have a Bit error rate (BER) due to multiple users. Where STBC with alamouti scheme can be proposed to minimize or solve the issue. While sending and receiving, the information is organized as a matrix with rows equaling the number of transmit antennas and columns equaling the number of receiving antennas. The reason that has made space-time block codes a very poplar scheme and most widely used is because it was designed to achieve the maximum diversity order for the given number of transmit and receive antennas with a simple linear decoding algorithm. Which also makes it easy and user friendly. We are proposing meaningful space-time block codes that use pilot sequences to estimate the channel coefficients. It will be proposed for different antenna combinations and modulation schemes. Firstly, we will review Alamouti scheme in details.

3.1 Alamouti Space-Time Code:

Space-time code is a generalized version of Alamouti scheme. So, in order to know about space time code, we will need to know about the Alamouti scheme. It is the first space-time block code scheme that provides full transmit diversity for systems with two transmit (Tx) and one receive (Rx) antennas.

We will start with the transmitter side, where we will take a block of two symbols from the source data which will be sent to the modulator. After that, Alamouti space-time encoder will take the two modulated symbols s_1 and s_2 . If encoding matrix represented as S than,

$$S = \begin{bmatrix} s_1 & s_2 \\ -s_2^* & s_1^* \end{bmatrix} \quad (2.1)$$

The symbol “*” represents the complex conjugate. Where s^* is the complex conjugate of s . There are two transmission periods from the two transmit antennas. The first transmission period where the signal s_1 is transmitted from antenna one and the signal s_2 is transmitted from antenna two. Now for the second transmission period, $-s_2^*$ signal is transmitted from antenna one and the signal s_1^* is transmitted from antenna two. How transmitter side uses Alamouti space-time encoder is shown in the figure below.

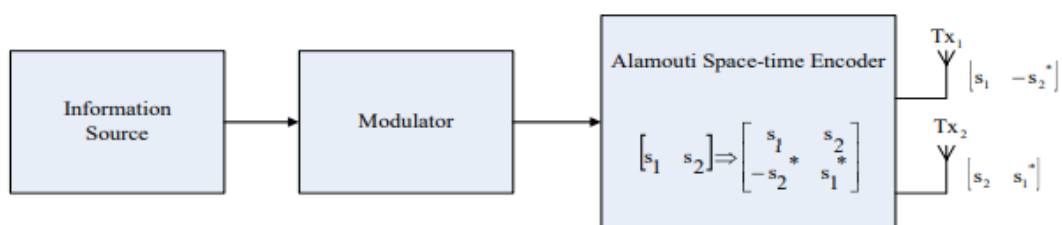

Figure 5: Alamouti space-time encoder diagram.

As we can see that the information's (signals) are send to the modulator and then Alamouti space-time encoder transmits the signals with the two transmit antennas. From

the block diagram we can summarize the encoding and mapping of this scheme as in Table 2.1

	Tx1	Tx2
t	s1	s2
t + T	-s2*	s1*

Table 2.1: Encoding and mapping for two transmit antennas using complex signals

Here, t represents the transmission symbol period. Tx1 and Tx2 are the representations of first and second transmit antennas. Where s1 and s2 are transmit sequence of antenna one and two. It can be represented as,

$$s^1 = [s_1 \quad -s_2^*]$$

$$s^2 = [s_2 \quad s_1^*]$$

From the equation we can see that the value of s1 and s2 is almost zero and from this we can say that the orthogonality of Alamouti scheme is confirmed.

Now, we will have a look at the process how Alamouti space-time system works with two transmit antennas and one receive antenna with a block diagram.

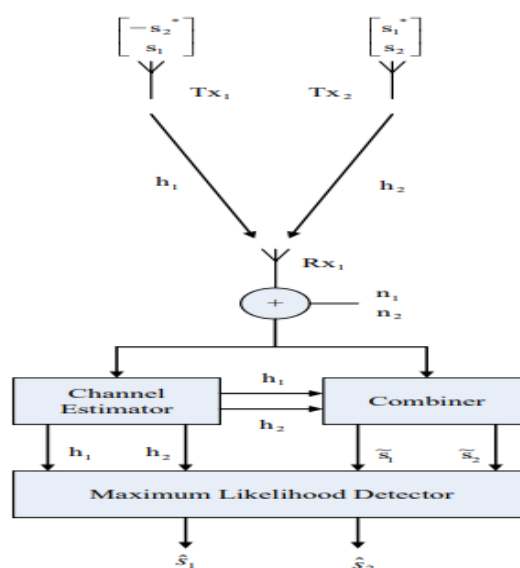

Figure 6: Alamouti space-time system with two transmit one receive antenna

From the block diagram of the Alamouti space-time system with two transmit one receive antenna, we can $h_1(t)$ and $h_2(t)$ which are the fading coefficients. Where these two coefficients are assumed constant during the two consecutive symbol transmission periods. We can define as,

$$h_1(t) = h_1(t + T) = h_1 = |h_1|e^{j\theta_1}$$

$$h_2(t) = h_2(t + T) = h_2 = |h_2|e^{j\theta_2}$$

We can express the channel coefficients of two Tx and one Rx antenna accordingly to the table below.

	Rx1
Tx1	h_1
Tx2	h_2

Table 2.2: Two transmit and one receive antenna channel coefficients

Here, Tx1 and Tx2 are the first and second transmit antennas and Rx1 is the receive antenna.

Now we will look at the Alamouti space-time decoder block diagram of the receiver side just as we have examined the encoder diagram.

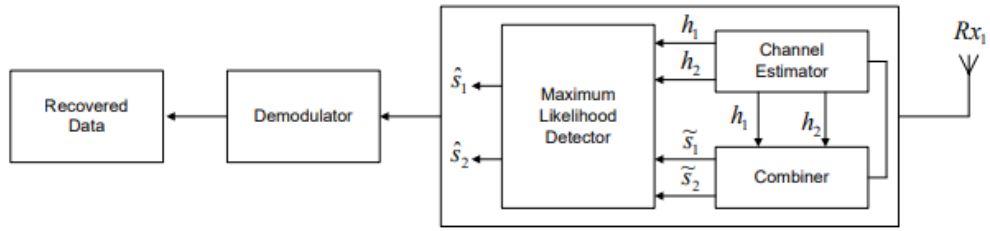

Figure 7: Alamouti space-time decoder diagram.

As we can see that the information's (signals) are received through the receive antenna Rx1 with two symbol periods for time t and $t+T$. From the diagram we can elaborate the received signals as below,

$$\begin{bmatrix} r_1 \\ r_2 \end{bmatrix} = \begin{bmatrix} s_1 & s_2 \\ -s_2^* & s_1^* \end{bmatrix} \begin{bmatrix} h_1 \\ h_2 \end{bmatrix} + \begin{bmatrix} n_1 \\ n_2 \end{bmatrix} = \begin{bmatrix} h_1 s_1 + h_2 s_2 + n_1 \\ -h_1 s_2^* + h_2 s_1^* + n_2 \end{bmatrix}$$

Where, n_1 and n_2 are independent complex variables.

ML Detection:

The receiver is always expected to have complete knowledge of the channel coefficients in most space-time codes. They are h_1 and h_2 in this situation. The channel state information will then be used by the Alamouti space-time decoder. From the signal constellation, ML decoder selects a pair of signals. It is done to minimize the distance matrix. Let's assume the signals are

\hat{s}_1 and \hat{s}_2 .

$$\begin{aligned} & d^2(r_1, h_1 \hat{s}_1 + h_2 \hat{s}_2) + d^2(r_2, -h_1 \hat{s}_2^* + h_2 \hat{s}_1^*) \\ &= |r_1 - h_1 \hat{s}_1 - h_2 \hat{s}_2|^2 + |r_2 + h_1 \hat{s}_2^* - h_2 \hat{s}_1^*|^2 \end{aligned}$$

For PSK signals, the decision rule is written as:

$$d^2(\hat{s}_1, s_i) \leq d^2(\hat{s}_1, s_k) \forall i \neq k$$

$$d^2(\hat{s}_2, s_i) \leq d^2(\hat{s}_2, s_k) \forall i \neq k$$

From figure 7, it can be seen that the combiner builds the following two combined signals which are sent to ML detector.

$$\begin{bmatrix} \tilde{s}_1 \\ \tilde{s}_2 \end{bmatrix} = \begin{bmatrix} h_1^* & h_2 \\ h_2^* & -h_1 \end{bmatrix} \begin{bmatrix} r_1 \\ r_2^* \end{bmatrix} = \begin{bmatrix} h_1^* r_1 + h_2 r_2^* \\ h_2^* r_1 - h_1 r_2^* \end{bmatrix}$$

Substituting the values of r_1 and r_2 , the decision matrix is expressed as:

$$\tilde{s}_1 = (|h_1|^2 + |h_2|^2)s_1 + h_1^* n_1 + h_2 n_2^*$$

$$\tilde{s}_2 = (|h_1|^2 + |h_2|^2)s_2 - h_1 n_2^* + h_2^* n_1$$

Using this equation, the ML decoding rule can be separated into two independent decoding rules for s_1 and s_2 .

$$\hat{s}_1 = \arg \min_{(\hat{s}_1, \hat{s}_2) \in C} (|h_1|^2 + |h_2|^2 - 1)|\hat{s}_1|^2 + d^2(\tilde{s}_1, \hat{s}_1)$$

$$\hat{s}_2 = \arg \min_{(\hat{s}_1, \hat{s}_2) \in C} (|h_1|^2 + |h_2|^2 - 1)|\hat{s}_2|^2 + d^2(\tilde{s}_2, \hat{s}_2)$$

Here, all modulated symbol pairs is represented by a set C.

3.2 Performance of Alamouti Scheme:

We know that Alamouti space time can achieve the full transmit diversity as it is orthogonal. But there are some disadvantages of Alamouti scheme as it cannot provide any coding gain. Because the rule is that there cannot be the same value or distance of two transmitted codes. If we do a simulation of bit error rate and signal to noise ratio performance in Alamouti scheme, then we have to assume that the receiver that is

receiving the signal exactly knows the signal it is receiving. And there will also be a condition that the total transmit power will have to be the same for all signals. And also, the fading will have to be mutually independent from every transmit antenna and receive antenna. From the Figure 6 we can see that if we run a simulation of Alamouti scheme of two transmit and one receive antennas then we can see that Maximal ratio combining (MRC) gained the same diversity as Alamouti scheme. Which can be present as the maximum diversity of for this system. Again, there is a disadvantage that Alamouti scheme is 3 dB less than the two-branch maximal ratio combining. The reason behind this situation is that there is double energy is radiating from the antenna in MRC than the antennas of Alamouti scheme. The rule was that both the power of MRC antenna and Alamouti antenna has to be the same. Talking about the advantage, after analyzing the performance of BER versus E_b/N_0 on flat Rayleigh fading channel we can easily say that the diversity of this system is maximum due to the Alamouti scheme with two transmit and one receive antennas. The reason for this improvement and better results is that higher order modulation schemes carry more bits per symbol which lower order modulations cannot. It will be much more helpful if we further analyze for two transmit antennas and one receive antenna of STBC in Complex Constellations. Then we will be able to find a better solution if Alamouti is better or STBC is better with the same power level and antennas. Further analysis will be STBC with two transmit antennas and two receive antennas.

3.3 Analysis of Space-Time Block Code:

We know that the generalize version of Alamouti is known as Space time block code or STBC in short. These codes have the same basic rules and systems. Just like Alamouti it can also achieve the full transmit diversity of a system or signal, but STBC is more complex than Alamouti's space-time code. Similarity is that encoding and decoding schemes are equal or same as transmitter and receiver sides. There is a rule to construct the data of the signal which has to be follow. The data will have to be use in a matrix

where rows of the matrix will have to be equal to the number of the transmit antennas and columns will have to be equal to the time slots needed to transmit the data. Now we have to analyze what will happen when data is send from the transmitter side and receiver gets it. The receiver side starts by receiving the signals then first it combines the data and then combined and then sends to the maximum likelihood detector. In the maximum likelihood detector, the decision rules are applied. Space-time block code was designed in such a way that with a simple decoding algorithm it achieves the maximum diversity order for the given number of transmit and receive antennas.

In the following, we will discuss about the implementations of space-time block codes which will be the encoding, decoding and system performance for two transmit antennas and one receive antenna.

It can be seen from the analysis of Alamouti space-time encoder diagram that space time block code and Alamouti code are quite the same when it is about encoding. From the start we know that if we want to transmit one block of code using STBC than it is defined by the number of transmit antennas n_T , the number of time periods which is represented by p and transmission matrix S . Now it is important to know the rate of space time block code. If we want to know about the rate of space time block code than we will be needing the input that space-time block encoder takes which can be represented with 'k' and the number of coded symbols which are transmitted. From the ratio of these two values, we can find the rate of space time block code. Again, if we want to calculate the rate of space time block code than it will simply be calculated through the equation below,

$$R = k/p$$

Where 'R' is the rate of space time block code, 'k' is the number of symbols or input that space-time block encoder took and 'p' is the number of transmit antennas.

For the simulation purpose we must figure out which type of signal we are transmitting. In order to transmit the signals, we need to know about the two types of signals that can be transmitted. There are real signals and complex signals. BPSK and PAM modulation schemes can be used to generate the real signal and opposite we have complex signal

which can be generated through complex modulation schemes like M-QPSK and M-QAM. The creation of space-time block code matrix will be depending based on real signals and complex signals. The transmitted real signals will need to be calculated by real transmission matrix like G_2 , G_4 which has the rate of one. If complex signals are used than transmission matrix G_2 is used if only the number of transmit antenna is one. Although there will be a difference if the number of transmit antennas are increased. If it's more than one, then we will have to use non-square matrix and the rate of those matrices are fractions like 0.5 or 0.75. The disadvantage of these matrices is that, achieving the full rate of one is not possible. On section 2.4 we will discuss about the Space-Time Block Codes for Real Constellations with two transmit antennas and one receive antenna. After that we will discuss about the Space-Time Block Code for Complex Constellations with two different methods. First will be two transmit and two receive antennas and secondly with four transmit antennas and one receive antenna.

3.4 Space-Time Block Codes for Real Constellations:

The purpose of designing a code is to construct complex transmission matrices which has a high rate but at the same time it has low decoding complexity. For this it will achieve the full diversity if the number of transmit antennas increases from one. In this research we will only discuss firstly about the transmitted real signals and for that real signal constellation will be used. Secondly, we will discuss about the Complex Constellations. We have already discussed that space-time block codes are allowed

to achieve the full rate if a real signal constellation is used as square matrix. It will also be able to gain the full transmit diversity. Real square transmission matrix S can be used if the number of transmit antennas are even numbers like 2, 4 or 8 etc. We need to keep in mind that the full rate $R = 1$ for these codes allowed to gain full transmit diversity of nT . Now we will discuss about two transmit and one receive antennas modulation for space time block code.

3.4.1 Two Transmit and One Receive Antennas:

The G2 square matrix which was used in Alamouti scheme can also be use in the transmission matrix for two transmit antennas as these are same. The only difference is in the real case, no symbol conjugations can be found. So, transmission matrix can be present as below,

$$S = \begin{bmatrix} s_1 & s_2 \\ -s_2 & s_1 \end{bmatrix}$$

The encoding and decoding part can also be construct as Alamouti scheme. So, we can easily calculate the receive signals as,

$$r_1 = h_1 s_1 + h_2 s_2 + n_1$$

$$r_2 = -h_1 s_2 + h_2 s_1 + n_2$$

The received signals and combined as,

$$\tilde{s}_1 = h_1 r_1 + h_2 r_2$$

$$\tilde{s}_2 = h_2 r_1 - h_1 r_2$$

The combined signals then are sent to ML detector just as Alamouti scheme.

	Tx1	Tx2
t	s1	-s2
t + T	s2	s1

Table 2.3: Encoding and mapping STBC for two transmit antennas using real signals.

3.5 Complex Constellations:

Now we will discuss about complex constellations with two transmit and two receive antennas modulation first and then four transmit antennas and one receive antenna for space time block code.

3.6 Space-Time Block Code for Complex Constellations

In Space-Time Block Code for Complex Constellations the target is to design or construct such matrices which has high-rate complex transmission with the ability of achieving full diversity and low decoding complexity. It will be applicable if the number of transmit antennas is greater than two.

3.6.1 Two Transmit and Two Receive Antennas

The encoding for space-time block codes has a great benefit that, STBC which are using two transmit antennas has the same encoding for Alamouti space-time code. The transmission matrix will use the same equation for a encoding matrix S described in Alamouti encoding.

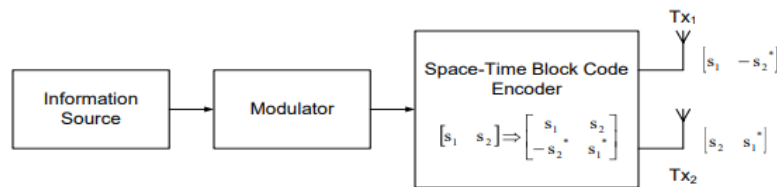

Figure 08: Space-time block encoder diagram.

From Figure 8, we can see that transmitter side is same as before but there is a change in receiver side. Last explanation had one receive antenna but this time we are going to discuss with two receive antennas. These two receive antennas will increase the receive diversity more than receiver with one antenna. The table below will show the channel coefficients for the space-time system which has with two transmit antennas and also two receive antennas.

	Rx1	Rx2
Tx1	h1	h3
Tx2	h2	h4

Table 2.4: Two transmit and two receive antennas channel coefficients.

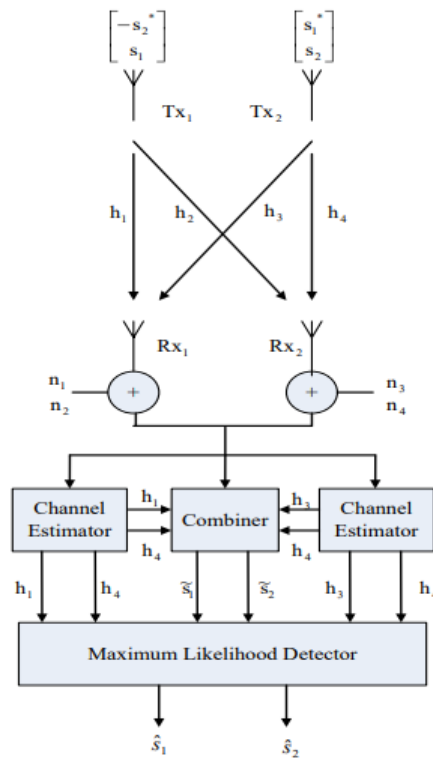

Figure 09: Space-time block code system with two transmit antennas and two receive antennas.

Now, in the two receive antennas if we denote the received signals as r_1, r_2, r_3 and r_4 for t and $t+T$ then an equation can be expressed as,

$$\begin{aligned}
 r_1 &= h_1 s_1 + h_2 s_2 + n_1 \\
 r_2 &= -h_1 s_2^* + h_2 s_1^* + n_2 \\
 r_3 &= h_3 s_1 + h_4 s_2 + n_3 \\
 r_4 &= -h_3 s_2^* + h_4 s_1^* + n_4
 \end{aligned}$$

The combiner showed in Figure 9 builds the signals are in below which will be next send to the maximum likelihood detector.

$$\begin{aligned}\tilde{s}_1 &= h_1^* r_1 + h_2^* r_2 + h_3^* r_3 + h_4^* r_4 \\ \tilde{s}_2 &= h_2^* r_1 - h_1^* r_2 + h_4^* r_3 - h_3^* r_4\end{aligned}$$

The rule for s1 and s2 in the maximum likelihood detector can be expressed as,

$$\begin{aligned}\hat{s}_1 &= \arg \min_{(\hat{s}_1, \hat{s}_2) \in \mathcal{C}} (|h_1|^2 + |h_2|^2 + |h_3|^2 + |h_4|^2 - 1) |\hat{s}_1|^2 + d^2(\tilde{s}_1, \hat{s}_1) \\ \hat{s}_2 &= \arg \min_{(\hat{s}_1, \hat{s}_2) \in \mathcal{C}} (|h_1|^2 + |h_2|^2 + |h_3|^2 + |h_4|^2 - 1) |\hat{s}_2|^2 + d^2(\tilde{s}_2, \hat{s}_2)\end{aligned}$$

3.6.2 Four Transmit antennas and One Receive Antenna

Now we will do the analysis of four transmit antennas and one receive antenna down below. From four transmit antennas four signals are transmitted at the same time. The signals transmitted from four antennas are denoted by s1, s2, s3 and s4. This process will remain same as long as the last column of the G4 transmission matrix is transmitted. The transmission is given below as the matrix.

$$S = \begin{bmatrix} s_1 & s_2 & s_3 & s_4 \\ -s_2 & s_1 & -s_4 & s_3 \\ -s_3 & s_4 & s_1 & -s_2 \\ -s_4 & -s_3 & s_2 & s_1 \\ s_1 & s_2 & s_3 & s_4 \\ -s_2 & s_1 & -s_4 & s_3 \\ -s_3 & s_4 & s_1 & -s_2 \\ -s_4 & -s_3 & s_2 & s_1 \end{bmatrix}$$

The matrix in the above equation is equal to the rate of half. And also, for the purpose of transmitting complex signal constellations it is used as STBC encoder. All the encoding, mapping and then the transmission can be explained as a summary in the table below.

	Tx1	Tx2	Tx3	Tx4
t	s1	s2	s3	s4
t + T	-s2	s1	-s4	s3
t + 2T	-s3	s4	s1	-s2
t + 3T	-s4	-s3	s2	s1
t + 4T	s1*	s2*	s3*	s4*
t + 5T	-s2*	s1*	-s4*	s3*
t + 6T	-s3*	s4*	s1*	-s2*
t + 7T	-s4*	-s3*	s2*	s1*

Table 2.5: Four transmit antennas encoding and mapping using complex signals.

After modeling the channel coefficients with complex multiplicative distortions for four antennas as h_1, h_2, h_3 and h_4 the figure below shows the scheme of four transmit and one receive antenna.

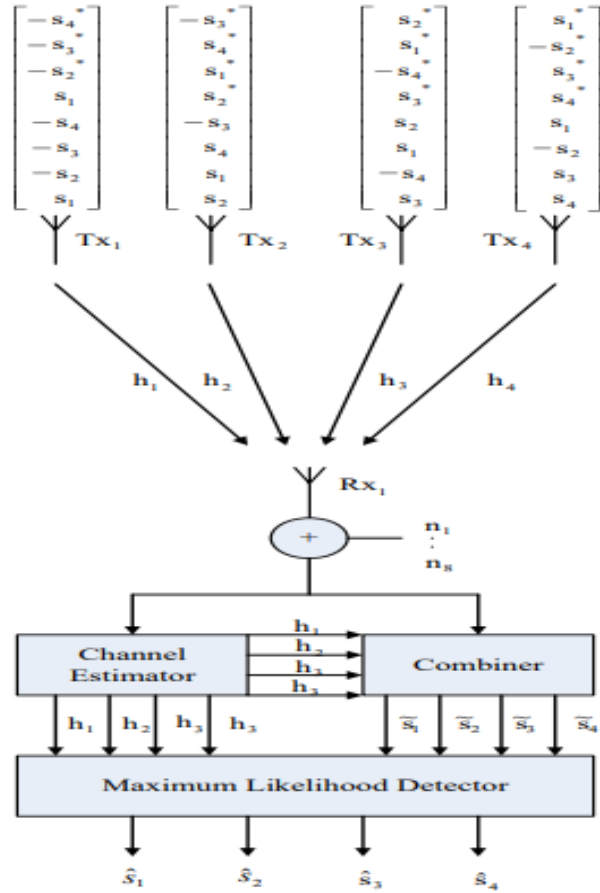

Figure 10: Space-time block code system with four transmit antennas and one receive antennas.

For the purpose of channel coefficients representation, we will assume a constant fading over four consecutive symbols. The representation will be as below,

$$\begin{aligned}
 h_1(t) &= h_1(t+T) = h_1 = |h_1|e^{j\theta_1} \\
 h_2(t) &= h_2(t+T) = h_2 = |h_2|e^{j\theta_2} \\
 h_3(t) &= h_3(t+T) = h_3 = |h_3|e^{j\theta_3} \\
 h_4(t) &= h_4(t+T) = h_4 = |h_4|e^{j\theta_4}
 \end{aligned}$$

Where $|h_i|$ and θ_i are the amplitude and phase shift where $i= 1, 2, 3$ and 4 . These are the path from transmit antenna i to receive antenna j . The channel coefficients for four transmit and one receive antenna can be seen in the table down below,

	Rx1
Tx1	h1
Tx2	h2
Tx3	h3
Tx4	h4

Table 2.6: Four transmit antennas and one receive antenna channel coefficients.

In this case eight different signals will be received by the receiver in eight different time slots. Those can be represented as down below,

$$\begin{aligned}
r_1 &= h_1 s_1 + h_2 s_2 + h_3 s_3 + h_4 s_4 + n_1 \\
r_2 &= -h_1 s_2 + h_2 s_1 - h_3 s_4 + h_4 s_3 + n_2 \\
r_3 &= -h_1 s_3 + h_2 s_4 + h_3 s_1 - h_4 s_2 + n_3 \\
r_4 &= -h_1 s_4 - h_2 s_3 + h_3 s_2 + h_4 s_1 + n_4 \\
r_5 &= h_1 s_1^* + h_2 s_2^* + h_3 s_3^* + h_4 s_4^* + n_5 \\
r_6 &= -h_1 s_2^* + h_2 s_1^* - h_3 s_4^* + h_4 s_3^* + n_6 \\
r_7 &= -h_1 s_3^* + h_2 s_4^* + h_3 s_1^* - h_4 s_2^* + n_7 \\
r_8 &= -h_1 s_4^* - h_2 s_3^* + h_3 s_2^* + h_4 s_1^* + n_8
\end{aligned}$$

The combiner showed in Figure 10 builds the signals are in below which will be next send to the maximum likelihood detector.

$$\begin{aligned}
\tilde{s}_1 &= h_1^* r_1 + h_2^* r_2 + h_3^* r_3 + h_4^* r_4 + h_1 r_5^* + h_2 r_6^* + h_3 r_7^* + h_4 r_8^* \\
\tilde{s}_2 &= h_2^* r_1 - h_1^* r_2 - h_4^* r_3 + h_3^* r_4 + h_2 r_5^* - h_1 r_6^* - h_4 r_7^* + h_3 r_8^* \\
\tilde{s}_3 &= h_3^* r_1 + h_4^* r_2 - h_1^* r_3 - h_2^* r_4 + h_3 r_5^* + h_4 r_6^* - h_1 r_7^* - h_2 r_8^* \\
\tilde{s}_4 &= -h_4^* r_1 - h_3^* r_2 + h_2^* r_3 - h_1^* r_4 - h_4 r_5^* - h_3 r_6^* + h_2 r_7^* - h_1 r_8^*
\end{aligned}$$

3.7 Performance of Space-time Block Code:

In the space time block code, any kind of code or scheme performance depends on the number of transmit antennas, receive antennas and the type of modulation. Now different type of performance of STBC will be discussed according to the analysis. We know that, if the number of transmit antennas is larger than two then, complex modulation is one step ahead then the real modulation in the case of better bit-error-rate performance. On the other hand, real modulation of space time block code can give better bandwidth efficiency performance rather than complex modulation. The reason behind this performance is when real modulation transmit it needs less data than the complex modulation. It is known to us that in the space time block code we can get better performance if large number of transmit antennas are used. Because large number of transmit antennas constructs larger transmission matrices which allows to transmit more data, and this leads to an improved transmission system.

Chapter 4

Antenna Diversity

From the previous works of this paper, we have learned that there are multiple antenna combinations can be done with MIMO system and STBC system. This different combinations on antennas are called multiple antenna techniques. These techniques are divided into two categories spatial multiplexing techniques or diversity techniques. The diversity technique is basically called the antenna diversity technique. Basic concepts of antenna diversity techniques will be discussed through this chapter. As from the research we have come to know that there are many antenna diversity techniques are available but transmit diversity techniques have been mostly using for the practice purpose. The benefit of this technique is it reduces the processing complexity of the receiver, and it needs multiple antennas only on the transmitter side not to the receiver side. In order to achieve the antenna diversity gain, we will be discussing the space-time coding techniques.

In a network system sometime error happens in the performance due to unstable wireless fading channels and we will use diversity techniques to reduce the error. The main idea of diversity in data transmission is that the deep fading of multiple independent fading channels is very low. Few ways of realizing diversity gain are listed below,

*Space diversity: Sufficiently separated multiple antennas are used to implement independent wireless channels.

*Polarization diversity: Independent channels are implemented using the fact that vertically and horizontally polarized paths are independent.

*Time diversity: Same information is repeatedly transmitted at sufficiently separated time instances. *Frequency diversity: Same information is repeatedly transmitted at sufficiently separated frequency bands.

*Angle diversity: Multiple receive antennas with different directivity are used to receive the same information-bearing signal at different angles.

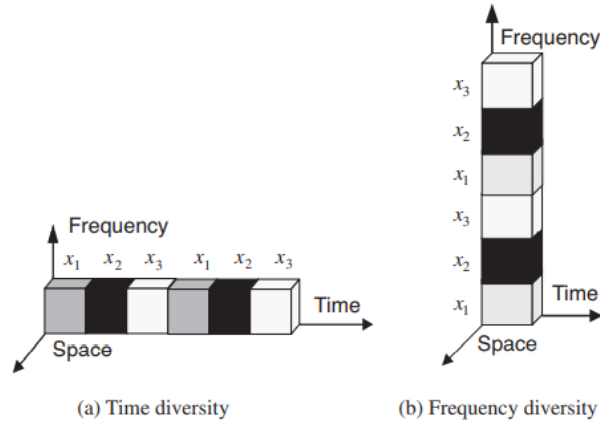

Figure 11: Time diversity and frequency diversity.

From Figure 11 we will get to know the techniques of time, frequency and spatial diversity. In time diversity, multiple time slots are used as data is transmitted over multiple time slots. The same data then transmitted at multiple spectral bands in the frequency diversity in order to achieve diversity gain. From Figure 11 (a) and 11(b) we learned that additional time resource and frequency resource are required for time diversity and frequency diversity techniques. On the other hand, no such resources are required for the antenna or space diversity techniques.

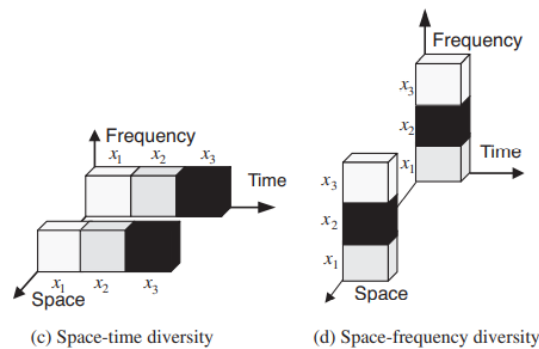

Figure 12: Space-time diversity and Space-frequency diversity.

Figure 12 (c) shows a concept of space-time diversity where it does not require additional time resource as it needed on Figure 11 (a) time diversity. Again, Figure 12 (d) shows a concept of space-frequency diversity which also does not require additional time resource as it needed on Figure 11(b) frequency diversity. From this two transmit antennas it is possible to construct different antenna configurations. Few of the examples are single input multiple output (SIMO), multiple input single output (MISO), and multiple input multiple output (MIMO).

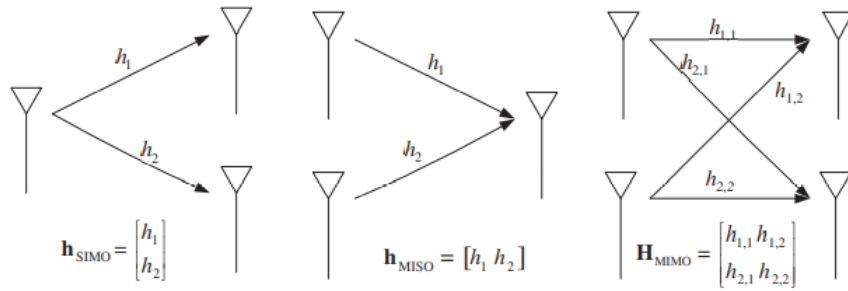

Figure 13: Examples of Different antenna configurations listed as SIMO, MISO AND MIMO.

4.1 Antenna configurations with Space time block code:

Space-time block coding is a technique used in wireless communications to transmit multiple copies of a data stream across several antennas and to exploit the various received versions of the data to improve the reliability of data transfer. We have discussed different antenna configurations in this chapter, now we will examine these configurations with space time block code or in short STBC. When space time block code is applied anywhere the first name that comes is Alamouti space time code. Space-time code is a generalized version of Alamouti scheme. So before learning about STBC it is necessary to learn the Alamouti schemes with different antenna configurations. For two transmit antennas alamouti space code is a complex orthogonal space-time code which is specialized in this section. First we will consider the Alamouti space-time coding technique and then we will move to the generalization for the case of three antennas or more.

4.1.1 Alamouti Space-Time Code:

Alamouti has developed a complex orthogonal space-time block code which was for two transmit antennas. For the alamouti encoder we will apply the same formula we have used in

the previous chapter but this time we will describe the values as x_1 and x_2 . For these two consecutive symbols space-time codeword matrix will be,

$$\mathbf{X} = \begin{bmatrix} x_1 & -x_2^* \\ x_2 & x_1^* \end{bmatrix} \dots\dots\dots(1)$$

From the two transmit antennas, Alamouti encoded signal is transmitted and it takes two symbol periods. x_1 and x_2 simultaneously transmitted signals from the two transmit antennas during the first symbol period. When the second symbol period comes, these symbols transmit again. This time $-x_2^*$ is transmitted from the first transmit antenna and x_1^* is transmitted from the second transmit antenna.

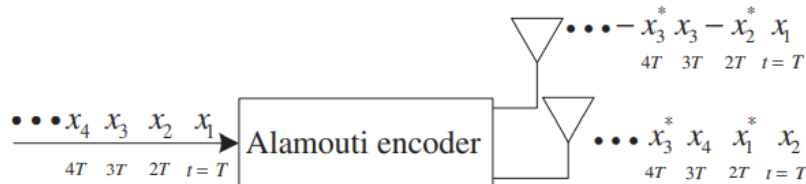

Figure 14: Alamouti encoder.

Now, Alamouti codeword \mathbf{X} in Equation (1)

$$\mathbf{X}\mathbf{X}^H = \begin{bmatrix} |x_1|^2 + |x_2|^2 & 0 \\ 0 & |x_1|^2 + |x_2|^2 \end{bmatrix} = (|x_1|^2 + |x_2|^2) \mathbf{I}_2$$

Here, \mathbf{I}_2 represents the 2×2 identity matrix. Since $N = 2$ and $T = 2$, the transmission rate of Alamouti code is shown,

$$\mathbf{X}_p = \begin{bmatrix} x_{1,p} & -x_{2,p}^* \\ x_{2,p} & x_{1,p}^* \end{bmatrix} \quad \text{and} \quad \mathbf{X}_q = \begin{bmatrix} x_{1,q} & -x_{2,q}^* \\ x_{2,q} & x_{1,q}^* \end{bmatrix}$$

Here,

$$[x_{1,p} \ x_{2,p}]^T \neq [x_{1,q} \ x_{2,q}]^T.$$

The minimum rank can be represented as,

$$\begin{aligned}
v &= \min_{p \neq q} \text{rank} \left\{ \begin{bmatrix} x_{1,p} - x_{1,q} & -x_{2,p} + x_{2,q} \\ x_{2,p} - x_{2,q} & x_{1,p} - x_{1,q} \end{bmatrix} \begin{bmatrix} x_{1,p} - x_{1,q} & -x_{2,p} + x_{2,q} \\ x_{2,p} - x_{2,q} & x_{1,p} - x_{1,q} \end{bmatrix}^H \right\} \\
&= \min_{p \neq q} \text{rank} \left\{ \begin{bmatrix} e_1 & -e_2^* \\ e_2 & e_1^* \end{bmatrix} \begin{bmatrix} e_1^* & e_2^* \\ -e_2 & e_1 \end{bmatrix} \right\} \\
&= \min_{p \neq q} \text{rank} \left\{ (|e_1|^2 + |e_2|^2) \mathbf{I}_2 \right\} \\
&= 2
\end{aligned} \tag{2}$$

From the equation (2) we can see that the diversity gain is 2. Note that the diversity analysis is based on the detection of the ML signal at the receiving end. We now discuss the detection of ML signals for the Alamouti spatiotemporal coding scheme.

Here we assume that two channel gains, $h_1(t)$ and $h_2(t)$, are time invariant for two consecutive symbol periods,

$$\begin{aligned}
h_1(t) &= h_1(t + T_s) = h_1 = |h_1| e^{j\theta_1} \\
h_2(t) &= h_2(t + T_s) = h_2 = |h_2| e^{j\theta_2}
\end{aligned} \tag{3}$$

Now if y_1 and y_2 represents the received signals at time t and $t + T_s$ then,

$$\begin{aligned}
y_1 &= h_1 x_1 + h_2 x_2 + z_1 \\
y_2 &= -h_1 x_2^* + h_2 x_1^* + z_2
\end{aligned} \tag{4}$$

Here, z_1 and z_2 are the additive noise at time t and $t + T_s$.

$$\begin{bmatrix} y_1 \\ y_2^* \end{bmatrix} = \begin{bmatrix} h_1 & h_2 \\ h_2^* & -h_1 \end{bmatrix} \begin{bmatrix} x_1 \\ x_2 \end{bmatrix} + \begin{bmatrix} z_1 \\ z_2^* \end{bmatrix} \tag{5}$$

From time t to $t + T_s$, the estimates for channels, \hat{h}_1 and \hat{h}_2 , are provided by the channel estimator. Here we will assume an ideal situation where the channel gains which are h_1 and h_2 will be exactly known to the receiver side.

$$\begin{aligned}
\begin{bmatrix} \hat{h}_1^* & h_2 \\ \hat{h}_2^* & -\hat{h}_1 \end{bmatrix} \begin{bmatrix} y_1 \\ y_2^* \end{bmatrix} &= \begin{bmatrix} \hat{h}_1^* & h_2 \\ \hat{h}_2^* & -\hat{h}_1 \end{bmatrix} \begin{bmatrix} h_1 & h_2 \\ h_2^* & -h_1^* \end{bmatrix} \begin{bmatrix} x_1 \\ x_2 \end{bmatrix} + \begin{bmatrix} \hat{h}_1^* & h_2 \\ \hat{h}_2^* & -\hat{h}_1 \end{bmatrix} \begin{bmatrix} z_1 \\ z_1^* \end{bmatrix} \\
&= (|h_1|^2 + |h_2|^2) \begin{bmatrix} x_1 \\ x_2 \end{bmatrix} + \begin{bmatrix} \hat{h}_1^* z_1 + h_2 z_1^* \\ h_2^* z_1 - \hat{h}_1 z_1^* \end{bmatrix}
\end{aligned} \tag{6}$$

From equation (6) we will get,

$$\begin{bmatrix} \tilde{y}_1 \\ \tilde{y}_2 \end{bmatrix} = (|h_1|^2 + |h_2|^2) \begin{bmatrix} x_1 \\ x_2 \end{bmatrix} + \begin{bmatrix} \tilde{z}_1 \\ \tilde{z}_2 \end{bmatrix} \quad \dots\dots\dots (7)$$

Where,

$$\begin{bmatrix} \tilde{y}_1 \\ \tilde{y}_2 \end{bmatrix} \triangleq \begin{bmatrix} h_1^* & h_2 \\ h_2^* & -h_1 \end{bmatrix} \begin{bmatrix} y_1 \\ y_2 \end{bmatrix}$$

$$\begin{bmatrix} \tilde{z}_1 \\ \tilde{z}_2 \end{bmatrix} \triangleq \begin{bmatrix} h_1^* & h_2 \\ h_2^* & -h_1 \end{bmatrix} \begin{bmatrix} z_1 \\ z_2 \end{bmatrix} \quad \dots\dots\dots (8)$$

From equation (8) we can see that there is no more other antenna interference exist. From this feature the simplified ML receiver structure can be written as,

$$\hat{x}_{i,ML} = Q\left(\frac{\tilde{y}_i}{|h_1|^2 + |h_2|^2}\right), \quad i = 1, 2. \quad \dots\dots\dots (9)$$

Here we assume independent Rayleigh fading channels and a perfect channel estimate at the receiver side. It is important to know that the Alamouti encoding achieves the same order of diversity as the 1 * 2 MRC technique.

Chapter 5:

Maximal ratio combining (MRC)

Every change in a signal need restoring ability or formula to restore it. Because many changes happen in the signal when it is transmitting through transmit antenna for many different purposes. Sometime changes are made for better performance and some time for better output result. All these are in vain if the received data is not the same and the full meaning is changed for that. In order to restore the data to its original shape a technique was invented by American engineer Leonard R. Kahn in 1954. This technique is call Maximal ratio combining or MRC in short. It is the optimum combiner for independent additive white Gaussian noise channels. For example, if we take a MIMO wireless system than, for the purpose of increasing the capacity of a link MIMO exploits the multipath propagation using multiple transmit antennas and receive antennas. The basic operation of MRC is that it adds together the signals which are transmitted from each channel, improving the signal quality of the receiver end, giving a better SNR gain etc. It is also known as ratio-squared combining or optimum combiner for independent additive white Gaussian noise channels.

Wireless communication system performance mainly depends on the environment of wireless channel. As wired channels are quite static and predictable according to their characteristics, on the other hand wireless channels are dynamic and unpredictable. So, it is quite difficult to make a perfect analysis of the wireless communication systems. Mobile communication services are rapidly growing in this era and this feature made it critical to optimize the wireless communication system. With the modern technology wireless channels has many characteristics and a unique characteristic of it is call 'fading'. Fading means the variation of the signal amplitude over time and frequency. In the wireless channel fading is a source of signal degradation which is characterized as a non-additive signal disturbance. Fading can be happened due to due to multipath propagation which can be named as multi-path fading. Again, it can also be happened by shadowing from obstacles that affect the propagation of a wireless signal and known as shadow fading. For a multiple antenna communication system, which is known as the MIMO (Multiple Input Multiple Output) system, research is going on aiming at high-speed wireless transmission and diversity gain. In order to mitigate the performance degradation of multipath fading a well-known technique called diversity combining has been used in wireless systems. When it is about the maximization of output signal-to-noise ratio (SNR), then maximal ratio combining (MRC) diversity is well known for this purpose in flat

fading channels. If co-channel interference (CCI) and flat fading affects the desired signal, then optimum combining (OC) technique can maximize the output signal-to-interference-plus-noise ratio (SINR). The disadvantage of this technique is that first OC is much more complex than MRC. Secondly, it requires the information about CCI which might not be available at the receiver. Again, it is easier to use MRC in the practice even in the presence of CCI. Diversity gain can also be provided by the transmit antenna array, and the optimum technique under background noise is Maximal Ratio Transmission (MRT) which is very much equivalent to MRC.

As we have mentioned before that maximal ratio combining (MRC) is the optimal linear combining technique. If there is MRC in the receiver than most of the complexity of that system gathers in the receiver side and it gets difficult. To reduce this receiver complexity a simple method of suboptimal combining scheme which was referring as to as selection combining (SC) was proposed in (W. C. Jakes Jr., *Microwave Mobile Communications*. Piscataway, NJ: IEEE Press, 1994.). The proposal was to modulate only one receive antenna which will have the largest SNR. The signals with more than one receive antenna which has the largest SNRs are combined will be the spot where selection combining scheme should be extended. This scheme is known as the MRC which is a powerful technique. In SIMO channels MRC is very common feature.

5.1 System Model:

For the purpose of multiple diversity many known techniques have been using by the researchers. Few of those are applied in single form and few of those are used as combined form. When it is about Maximum Ratio combining every signal branch must be multiplied by proportional weight factor the signal amplitude. Where strong signal branches are further amplified, and the weak signals are being reduced. For wireless communications diversity combining method is called maximal ratio combining. In MRC signals from different channels are combined together. For the gain of each channel, it must be equally proportional to the RMS value of that signal and inversely proportional to the mean square noise level in that channel. For different channels different proportionality constants are being used in this method. This method has other names also like ratio-squared combining and pre-detection combining. Firstly, the signals that comes from different MR branches must weighted accordingly to their individual SNRs. Secondly the sum of all is calculated in the MRC.

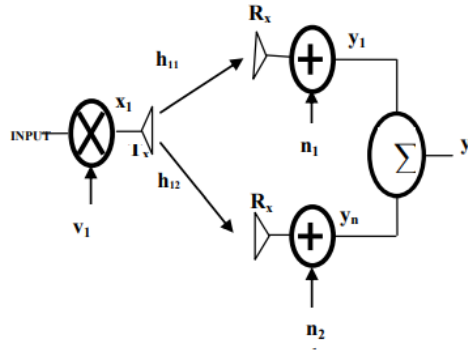

Figure 15: Maximal ratio combining with one transmit antenna and two receive antennas.

From Figure 15 we can get the representation knowledge of Maximum ratio combining with one transmit antenna and two receive antennas. In order to form the transmitted signal vector, the symbol which are being transmitted is weighted with a transmit weighting vector. If we have a look at the received signal vector, then we can see that it is a product of transmitted signal vector and the channel plus the noise.

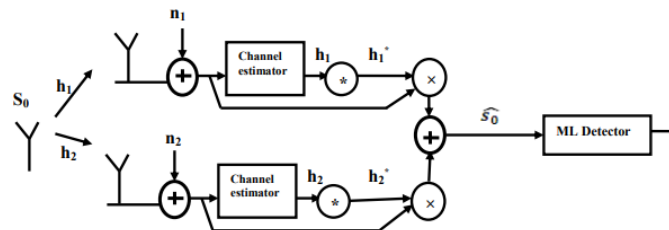

Figure 16: Block Diagram of MRC.

From the analysis of Figure 16 which is about the individual RF receiver tracts we can say that the received signals are,

$$r1 = h1s0 + n1 \dots(1)$$

$$r2 = h2s0 + n2\dots .(2)$$

If we combine signal (1) and (2) then we get,

$$\tilde{s}_0 = h_1 * r_1 + h_2 * r_2 \dots \dots \dots (3)$$

Here, h1 and h2 defines the fading coefficients from antennas 1 and 2. Again, if we consider time is 't' then n1 and n2 are independent complex variables where it represents white Gaussian noise samples at time 't'.

$$Y = H * x + n \dots \dots \dots (4)$$

Where the transmitted signal x can be represented by,

$$X = [X_1 \dots \dots \dots X_K]^T \dots \dots \dots (5)$$

$$= C[V_1 \dots \dots \dots V_K]^T \dots \dots \dots (6)$$

If we consider a system or channel which has K antennas for transmission and L antennas for reception, then that channel consists statistically independent coefficients which is K*L. From Figure 15 it can be smoothly represented with a matrix,

$$H = \begin{bmatrix} H_{11} & \dots & H_{1K} \\ \vdots & \ddots & \vdots \\ H_{L1} & \dots & H_{LK} \end{bmatrix} \dots \dots \dots (7)$$

Here, H is complex Gaussian random variable which is independent and identically distributed. It has zero mean and variance 0.5 per dimension. Again, n is complex Gaussian random variable which is independent and identically distributed. It also has zero mean, but the variance is No/2 per dimension. When it is about the Non-Line of Sight wireless radio propagation than Rayleigh distribution is the most useable. The concept of MRC also used for the MIMO channel capacity when it was investigated for Rayleigh fading channel model. For calculation and research purpose an assumption is made that channel state information (CSI) is known perfectly at the receiver side but not at the transmitter side. The channel fading coefficients remains the same over the whole frame and changes from one frame to another. Theoretically, the capacity of such MIMO system which is full complex and uses all available transmit and receive antennas can be presents as,

$$C_{\text{full}} = \log_2 \det \left(I_{NR} + \frac{E_s}{(N_T N_0)} \right) \quad \text{if } N_R < N_T$$

Where, I_{NR} is $N(R) \times N(R)$ identity matrix and the noise vector can be represented as,

$$\mathbf{n} = [n_1 \dots n_L]^T \dots \dots \dots (8)$$

We assume noise to be white Gaussian and uncorrelated with the signals. It is known to us that mobile radio channel is a time-varying multipath channel and if it is affected by outside noise or get any interference then increase happens in bit error rate (BER).

$$p(y_i) = \frac{1}{\left(\frac{E_b}{N_0}\right)} e^{-\frac{y_i}{\left(\frac{E_b}{N_0}\right)}}$$

Here, E_b/N_0 is signal to noise ratio, Y is the sum of N such random variables. With $2N$ degrees of freedom,

$$p(y) = \frac{1}{(N-1)! \left(\frac{E_b}{N_0}\right)^N} y^{N-1} e^{-\frac{y}{\left(\frac{E_b}{N_0}\right)}}, y \geq 0$$

Now, with bit energy to noise ratio of E_b/N_0 the the bit error rate will be,

$$P_b = \frac{1}{2} \operatorname{erfc} \left(\sqrt{\frac{E_b}{N_0}} \right)$$

Again, the effective bit energy to noise ratio with maximal ratio combining is Y then the equation is,

$$P_e = p^N \sum_{k=0}^{N-1} (N-1+k) (1-p)^k$$

Where,

$$p = \frac{1}{2} - \frac{1}{2} \left(1 + \frac{1}{E_b/N_0} \right)^{-1/2}$$

In the total interference, the central limit theorem can be applied under the Rayleigh fading system. In this path the average error rates can be calculated by conditional error probability (CEP). Further studies can bring various new paths for the solution to this problem.

Chapter 6

Channel Capacity of MIMO Systems:

MIMO (Multiple-Input Multiple-Output) systems are used in wireless communication to increase capacity. The primary goal of this article is to investigate MIMO system capacity and monitor MIMO system performance using the Waterfilling Algorithm. The two primary benefits of MIMO systems that are used to investigate the effect of higher bit rate with increasing the number of transmitter and receiver antennas are diversity gain and spatial multiplexing gain. The rise in order of diversity in diversity gain, as well as the direct proportionality of transmit and receive antennas in spatial multiplexing gain, account for these benefits. The singular value decomposition (SVD) of the received signal, which is formed of a collection of parallel sub channels, is used to solve the problem of maximizing the capacity of a MIMO system using water filling algorithm on a Rayleigh fading channel. We looked at how the capacity of a MIMO system changes with the number of transmit and receive antennas, as well as how the statistical parameters of the diagonal matrix generated by singular value decomposition of the MIMO system change. If P_T power is allocated to a random MIMO channel, the capacity of the system can be written as:

$$C = E_H \left(\max_{p(x|y), (p) p \leq P_T} I(X; Y) \right)$$

Covariance matrix of T_x signal vector x is $\Phi = E\{xx^\dagger\}^2$. Whether we increase or decrease the transmitter antennas; total power of the system P_T remains the same. For a given H , the co-relation between mutual information and entropy may be extended as follows:

$$\begin{aligned} I(X; Y) &= H(Y) - H(Y/X) \\ I(X; Y) &= H(Y) - H((HX + n)/X) \\ I(X; Y) &= H(Y) - H(n/X) \\ I(X; Y) &= H(Y) - H(n) \end{aligned}$$

Where H denotes the entropy symbol. The transmit vector X and the noise vector n are not dependent on each other. As H is constant (zero entropy) during the transmission of

a full block of X, the third equation in the preceding set of equations holds. When Y has the maximum entropy of $\log_2 \det [\Pi e K]$, the $I(X; Y)$ is maximized, which necessitates Y to have a covariance matrix :

$$E[yy^\dagger] = k$$

Where “ \dagger ” is complex conjugate transpose, k can be found from a complex Gaussian vector X with $E[xx^\dagger] = Q$

$$\begin{aligned} K &= E[(HX+n)(HX+n)^\dagger] \\ &= E[HXX^\dagger H^\dagger] + E[n n^\dagger] \\ &= HQH^\dagger + (K)^n \\ &= (K)^s + (k)^n \end{aligned}$$

This equation is true as X and n are independent. $(K)^s$ denotes the signal part and $(k)^n$ denote the noise part of the covariance matrix. The maximum mutual information is

$$C = H(Y) - H(n)$$

$$C = \log_2 [\det (\Pi e ((K)^s) + (K)^n)] - \log_2 [\det(\Pi e(K)^n)]$$

$$C = \log_2 [\det[((K)^s * ((K)^n)^{-1}] + I_r)]$$

I_r is an identity matrix of dimension r-by-r. Let's assume each antenna at the receiver end have noises uncorrelated to each other; therefore $K_n = (\sigma)^2 * I_r$. Noise power of each receiving antenna is denoted by $(\sigma)^2$. When the transmitter has no CSI information, it is best to allocate equal power on each antenna. Therefore $Q = (P_T/t) * I_t$. P_T is the total transmitter signal power available. Therefore, channel capacity for MIMO system is:

$$C = \log_2 [\det[HQH^\dagger * ((K)^n)^{-1}] + I_r]$$

The average SNR for each receiving antenna is $= P_t / (\sigma)^2$, and H^\dagger is the complex conjugate transpose of H. We use the Singular Value Decomposition on H to diagonalize it and obtain the eigen values in order to explore its properties.

6.1. Singular Value Decomposition:

The quality of the channel state information at the transmitter and receiver determines the performance of a system utilizing Singular Value Decomposition across a Multiple Input Multiple Output channel. Because the channel in time division duplex (TDD) systems is reciprocal, the CSI may be retrieved and used for transmission by estimating pilot symbols. The SVD results in a simple method that decomposes the MIMO channel matrix into parallel SISO sub channels with unequal gains. The water filling method is the best power allocation for these sub channels if the receiver noise at the transmitter is known and the overall transmitter power is fixed. SVD of the matrix H is $H = UDV^\dagger$. D represents diagonal matrix with positive real elements whereas U and V are unitary. To have a Singular Value Decomposition, the matrix does not have to be square. Singular values of the matrix H is represented by the elements of D . Positive square roots of the eigenvalues of the matrix HH^\dagger or $H^\dagger H$ are also equal to these elements. The channel state information in a time division duplex channel is provided with good precision at both ends of the communication link. This channel information is used while computing the SVD. Vector x is filtered via V before being sent across the channel, while vector Y is filtered through U^\dagger . As a result, the entire transmission equation becomes:

$$Y = U^\dagger (Hx + n)$$

$$Y = U^\dagger ((UDV)x + n)$$

$$Y = U^\dagger ((UDV)V^\dagger x + n) \quad x = V^\dagger x$$

$$Y = (U^\dagger U) D (V V^\dagger) x + U^\dagger n$$

$$Y = D x + n \quad n = U^\dagger n$$

U and V are unitary matrixes with dimensions r -by- r and t -by- t respectively whereas diagonal matrix D (r -by- t) consist of singular values $\{\sigma_i\}$ of H . The i th eigen value of HH^\dagger is λ_i , and it is equal to the square of the singular value.

$$\sigma_i = \sqrt{\lambda_i} ; \text{ Component wise : } Y_i = D_{ii} x_i + n_i$$

Through transmit precoding and receive shaping, the parallel decomposition of the channel is achieved by specifying a transformation on the channel input and output X and Y .

If the input vector is X , during transmit pre-coding a linear transformation on the input vector X is done by which input to the antennas, X is generated as $X = V^\dagger X$.

By multiplying the channel output, Y , by U^\dagger , receiver shaping accomplishes a similar action at the receiver.

6.2. Water Filling Algorithm:

Engineering issues that may be stated as constrained optimization problems have solutions provided by water filling structures, with the capacity attaining solution for the MIMO channel. A water filling solution is also found for the challenge of jointly constructing the transmitter and receiver for communication via MIMO channel[16]. The well-known classical waterfilling solution solves the problem of maximizing mutual information between the input and output of a channel made up of multiple sub channels (for example: a frequency-selective channel, a time-varying channel, or a set of parallel subchannels resulting from the use of multiple antennas). The inverse of the sub channel gains gives this capacity-achieving technique the visual interpretation of pouring water over a surface, hence it is termed waterfilling or water pouring[16].

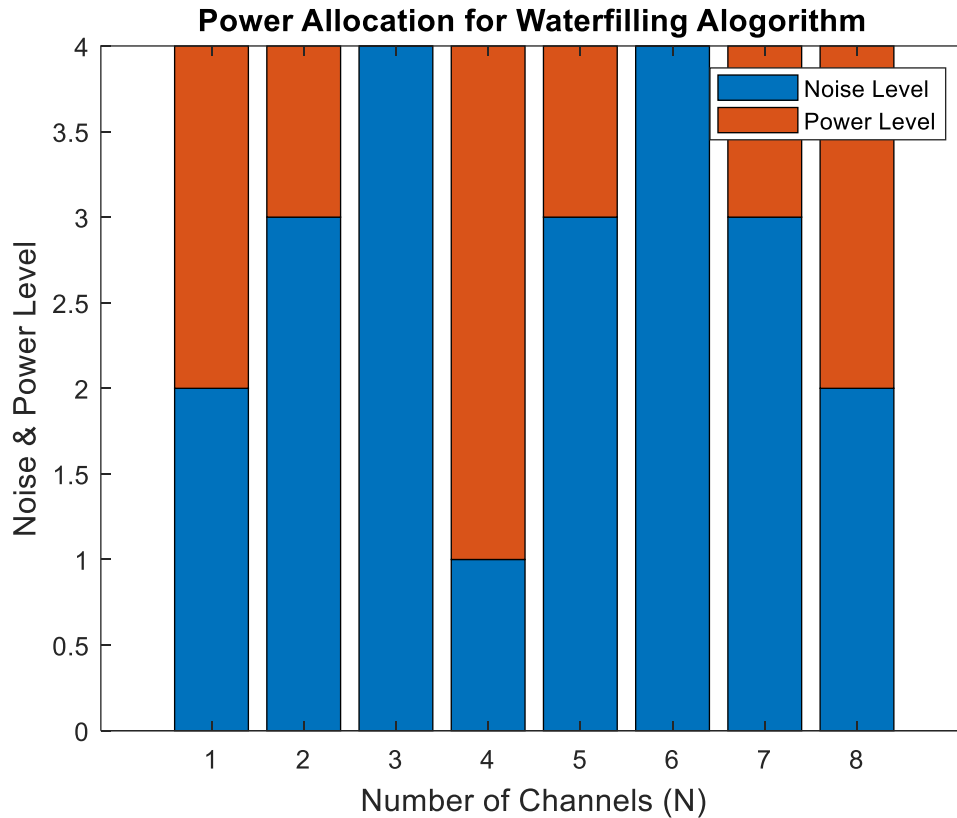

Figure 17: Power Allocation for Waterfilling Algorithm

6.3. MIMO Waterfilling Capacity:

Individual sub channels are not accessible when channel information is missing at the transmitter. As a result, in this case, equal power distribution in all sub channels is reasonable. The waterfilling approach is used to improve the broadcast signal strength when the transmitter has complete information of the channel. The waterfilling theory divides total power in such a manner that more or even none of it gets to sub channels with larger gains and less or even none goes to sub channels with small gains. Sub channels with lower gain, i.e., those with more noise for which no power is provided, refer to sub channels that are not utilized to transmit any signal during transmission. The goal of this method is to optimize overall capacity by allocating power throughout the channel. The sum of the power poured into all sub channels must equal P_T , the total power available to the transmitter, for this power allocation to work. Knowledge of the channel matrix, H , determines the relative channel strengths and the amount of power

to assign to each channel. To obtain H with dimension r-by-t , eigen decomposition of H is done where $H = UDV^\dagger$. Here, $UU^\dagger = I_r = VV^\dagger = I_t$. D = diagonal $\lambda_1, \lambda_2, \lambda_3 \dots \lambda_n$ with λ_i , being the positive square root of i^{th} eigen value whereas $i = 1$ to n non zero λ values and

$$n = \min \{r,t\}.$$

A parameter, "μ" is a mathematical parameter that determines how much power is allocated to each of the composite MIMO channel's sub channels. Following the determination of μ, the square of the inverse of eigen values is compared to it. If

$1/\lambda^2 \geq \mu$; the i^{th} eigen channel is far too weak to be utilized for communication. Such channels are stated to be switched off and removed from the communication process, implying that no transmitting power is assigned to those specific sub channels.

The ideal power assigned to the i^{th} sub channel is determined once the total available power, P_T , and gains of the parallel sub channels are known.

$$P_i = \left(\mu - \frac{1}{\lambda_i^2} \right)$$

If P_i is positive , power is allocated to i^{th} sub channel, other than that the sub channel is not used. The water filling parameter μ is calculated iteratively by the total power P_t , so that the following equation is satisfied.

$$P_T = \sum_{i=1}^m \left[\mu - \frac{1}{\lambda_i^2} \right]$$

$i = 1,2,3,\dots,m$; here m is the total number of sub channels that have fulfilled the above conditions and P_i is found positive for them. With water filling, the capacity of a MIMO channel may now be represented as

$$C = \sum_1^m \log_2 \left[1 + (P_i/\sigma^2) * \lambda_i^2 \right] \text{bps/Hz}$$

The above equation allows us to visualize the MIMO channel as a series of parallel SISO pipes with gain equal to the respective eigen values and understand that the

waterfilling capacity for MIMO channels is the sum of the capacities of the SISO equivalent parallel sub channels obtained by performing SVD on the MIMO channel matrix. If the transmitter knows the channel, capacity may be increased by utilizing the best channels, i.e. those with the highest gain, and using an uneven power distribution.

6.4 Summary of power allocation steps:

1. Determining the water filling parameter or threshold μ .
2. Comparing the inverse of eigen values of the matrix H with the threshold.
3. For the cases where $1/\lambda^2 \geq \mu$, i^{th} eigen channel gain is too small and thus not considered for data transmission.
4. Consider $r=t$ (square dimension). Assume the case for $\lambda_1 \geq \lambda_2 \geq \lambda_3 \geq \dots \lambda_t$. Consider that m eigen values that have fulfilled the above criteria.
5. The ideal power assigned to the i^{th} sub channel is determined after the total available power, P_T , and gains of the parallel sub channels are known:

$$p_i = \left(\mu - \frac{1}{\lambda_i^2} \right)$$

The waterfilling rule determines the power allotted to each of these eigen channels, P_i , so that the following equations are fulfilled.

$$\frac{1}{\lambda_1^2} + P_1 = \frac{1}{\lambda_2^2} + P_2 = \dots = \frac{1}{\lambda_m^2} + P_m = \mu \quad \text{for } i = 1, 2, \dots, m.$$

$$P_T = \sum_{i=1}^m \left[\mu - \frac{1}{\lambda_i^2} \right] \quad \text{and}$$

$$P_T = P_1 + P_2 + \dots + P_m$$

If P_i is positive, the power P_i is allocated for the i^{th} sub channel, other than that the channel is not used.

Calculation of μ :

$$\frac{1}{\lambda_1^2} + P_1 = \frac{1}{\lambda_2^2} + P_2 = \dots = \frac{1}{\lambda_m^2} + P_m = \mu$$

$$P_T = P_1 + P_2 + \dots + P_m$$

$$m\mu = \sum_{i=1}^m \frac{1}{\lambda_i^2} + \sum_{i=1}^m P_i = \sum_{i=1}^m \frac{1}{\lambda_i^2} + P_T$$

$$\mu = \frac{1}{m} \left[\sum_{i=1}^m \frac{1}{\lambda_i^2} + P_T \right]$$

6.5 Power allocation with known channel state information:

The information about the channel condition is usually provided at the receiver (CSIR).

The channel status information is also accessible at the transmitter if the receiver provides the CSI to the transmitter through a feedback channel (CSIT). Closed loop MIMO is the name given to such a system.

To improve spectral efficiency, we may now distribute power to individual transmit antennas adaptively.

As a result, the channel capacity may be re-written as:

$$C = W \sum_{i=1}^{R_H} \log_2 \left(1 + \frac{\lambda_i P_i}{\sigma^2} \right)$$

Here, W is the bandwidth of the channel and R_H is the number of parallel sub channels.

Now, to maximize C , choosing P_i properly is essential. The total transmit power P is always fixed in the system. Re-writing the equation for capacity:

$$C = W \sum_{i=1}^{R_H} \log_2 \left(1 + \frac{P \lambda_i P_i}{P \sigma^2} \right) = W \sum_{i=1}^{R_H} \log_2 \left(1 + \frac{\gamma_i P_i}{P} \right); \gamma_i = \frac{P \lambda_i}{\sigma^2}$$

Introducing the cost or objective function by using the method of Lagrange multipliers:

$$F = \sum_{i=1}^{R_H} \log_2 \left(1 + \frac{\gamma_i P_i}{P} \right) + \zeta \left(P - \sum_{i=1}^{R_H} P_i \right)$$

where, ζ is the Lagrange multiplier.

Setting the partial derivative of the cost or objective function F to zero yields the unknown transmit power P_i .

$$\begin{aligned}
& \frac{dF}{dP_i} = 0 \\
\Rightarrow & \frac{d \left\{ \log_2 \left(1 + \frac{\gamma_i P_i}{P} \right) - \zeta P_i \right\}}{dP_i} = 0 \\
\Rightarrow & \frac{1}{\ln(2)} \frac{1}{1 + \frac{\gamma_i P_i}{P}} \frac{\gamma_i}{P} - \zeta = 0 \\
\Rightarrow & \frac{1}{\frac{P}{\gamma_i} + P_i} - \zeta \ln(2) = 0 \\
\Rightarrow & P_i = \frac{1}{\zeta \ln(2)} - \frac{P}{\gamma_i} \\
\Rightarrow & \frac{P_i}{P} = \frac{1}{\zeta \ln(2)} - \frac{1}{\gamma_i} \\
\Rightarrow & \frac{P_i}{P} = \frac{1}{\gamma_0} - \frac{1}{\gamma_i}
\end{aligned}$$

Sub channel power allocation is greater or equal to zero ($P_i \geq 0$). Therefore:

$$\Rightarrow \frac{P_i}{P} = \left[\frac{1}{\gamma_0} - \frac{1}{\gamma_i} \right]^+$$

The notations here are:

$$[k]^+ = \begin{cases} k, & k > 0 \\ 0, & k \leq 0 \end{cases}$$

So the power constraint is

$$\sum_{i=1}^{R_H} \frac{P_i}{P} = \sum_{i=1}^{R_H} \left(\frac{1}{\gamma_0} - \frac{1}{\gamma_i} \right)^+ = 1$$

Channel capacity for MIMO system with known CSI may be re-written as follows:

$$C = W \sum_{i=1}^{R_H} \log_2 \left(1 + \frac{\gamma_i P_i}{P} \right) = W \sum_{i=1}^{R_H} \log_2 \left(1 + \gamma_i \left(\frac{1}{\gamma_0} - \frac{1}{\gamma_i} \right)^+ \right) = W \sum_{i: \gamma_i \geq \gamma_0}^{R_H} \log_2 \left(\frac{\gamma_i}{\gamma_0} \right)^+$$

Results and Discussion:

In this paper, we have discussed the techniques involve in reducing bit error rate of a communication system. Alamouti scheme and space time block coding are used in Rayleigh fading channels to reduce the bit errors for a given SNR. MATLAB simulation was done to show the relation between SNR and BER with increasing number of transmitter receiver antennas. After that the effect of MIMO system with space time block coding to increase the system capacity was simulated in MATLAB. Through simulation of cumulative distribution of capacity and normalized probability of SVD it is shown how consistently the system performs in different scenarios. Later BER performance of different modulation scheme in MIMO Alamouti system was coded to analyze and find the most desirable schemes.

1. BER Vs SNR of MIMO system:

In the figure we can see that the system was evaluated for four transmitter receiver combinations which are 1*1, 2*1 , 1*2 and 2*2.

BER for BPSK modulation with Alamouti STBC and MRC (Rayleigh channel)

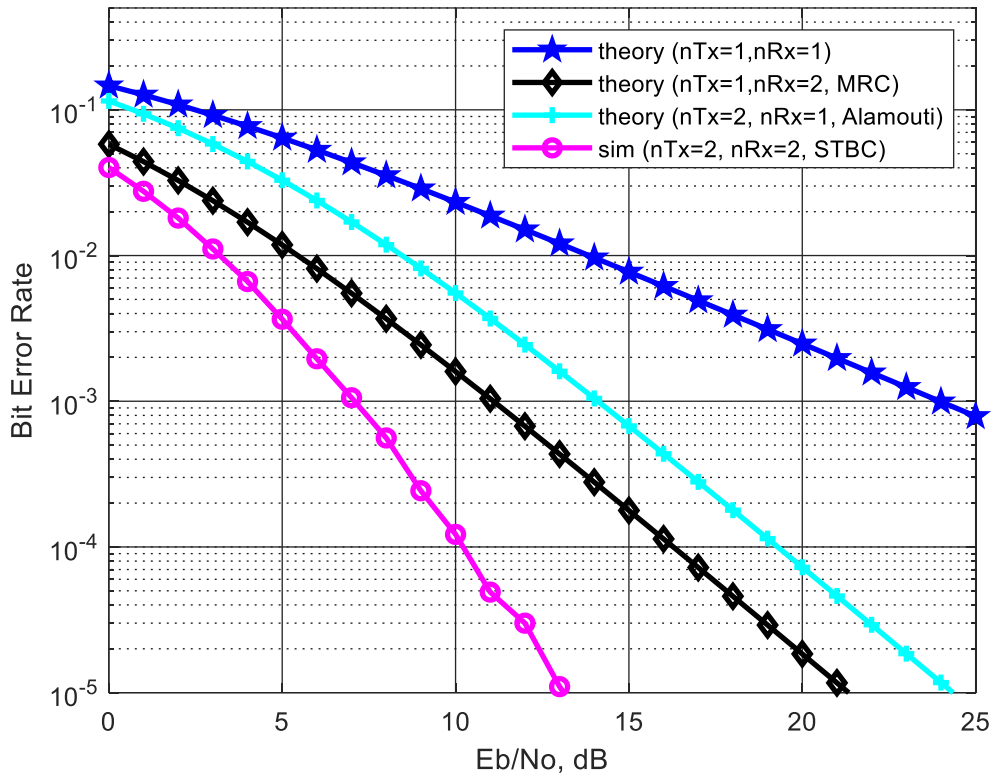

Figure 18: BER for BPSK modulation with Alamouti STBC and MRC

From the graph it can be seen that for a SISO system, bit error is very high. This is due to constraints like inter symbol interference and fading. By using Alamouti (2*1) system, BER is reduced significantly. This happens because of the reduction in inter symbol interference. Maximal ratio combining are capable of reducing the power of interfering signals at the receiver. From the simulation MRC(1*2) is found out to be more effective than Alamouti(2*1) to reduce bit error. And when a system is designed with an increase in both transmitter and receiver antennas (2*2), bit error is found to be the lowest. It combines the effect of spatial diversity gain and spatial multiplexing gain.

2. Average channel capacity:

From the simulated graph it can be seen that increasing the number of transmitter and receiver antenna results in an increase of channel capacity. This is due to the fact that the effect of STBC and MRC combining together yields in a better throughput.

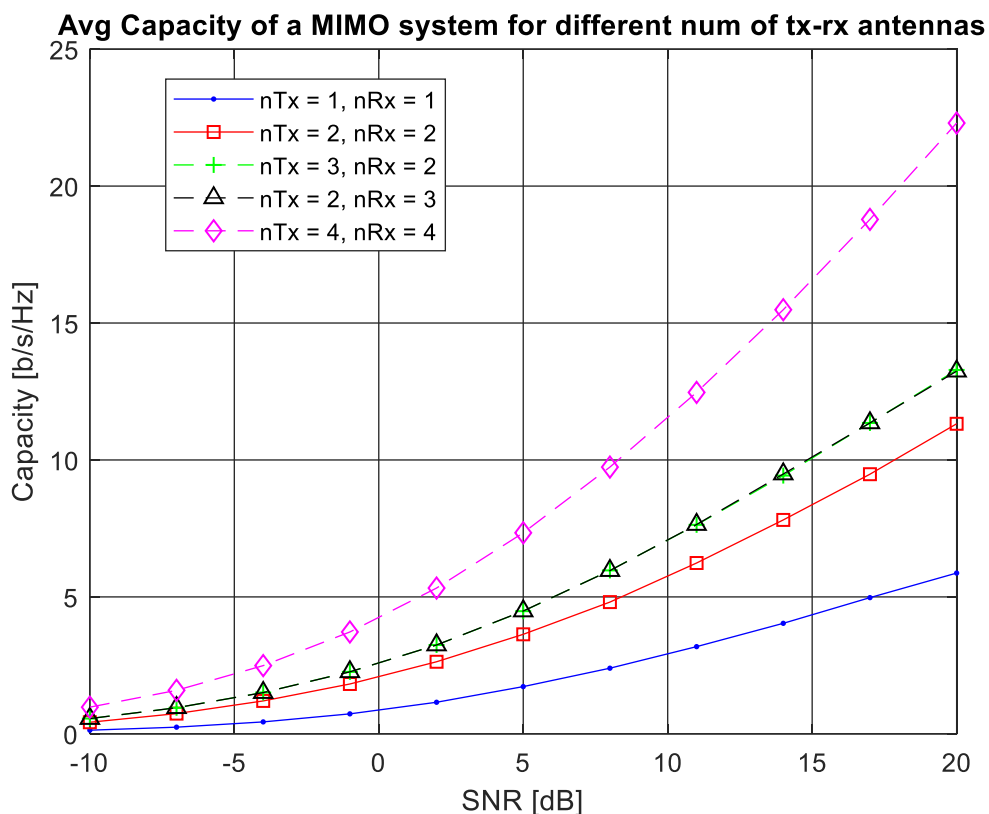

Figure 19: Avg Capacity of MIMO system for different num of tx-rx antennas

The consistency of the system was also evaluated by simulation through cumulative distribution function of Capacity at SNR = 5 dB. Due to different channel constraints such as signal leaks to the adjacent cells, channel fading, ISI; the capacitive value of a given transmitter receiver can shift by a little margin,

but from CDF simulation it can be seen that the probability of capacity being reduced significantly is very low. And very rarely the capacity of higher order transmitter receiver system can go below the capacity of lower order transmitter receiver system; as the probability is very very low for higher order $T_x - R_x$ system.

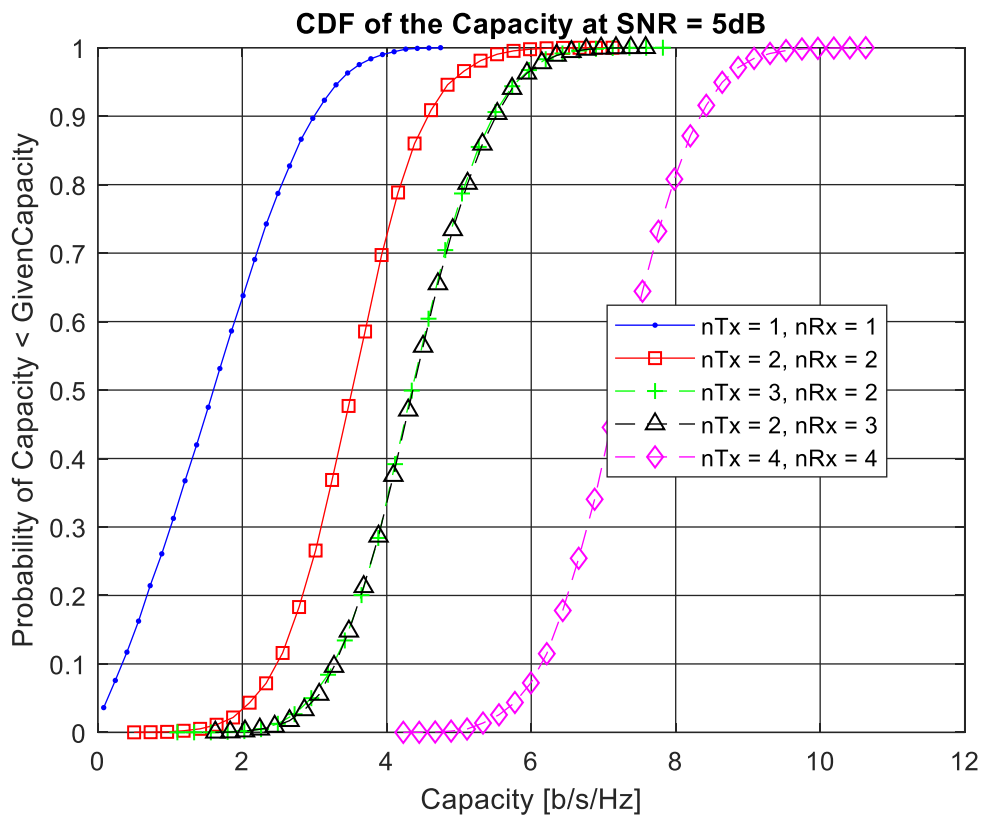

Figure 20: CDF of the Capacity at SNR=5dB

Later we analyzed the SVD values by plotting normalized probability against the allocated power of singular values. Likewise, the previous case, the probability of allocating more power for 1st singular value is higher than 2nd singular value for most cases, and 2nd singular value has more power than 3rd singular value and so on. On some occasion, T_x may not have the perfect CSI information; so power

allocation for sub channels may get faulty and thus in rare occasions power of a lower order singular value can get higher.

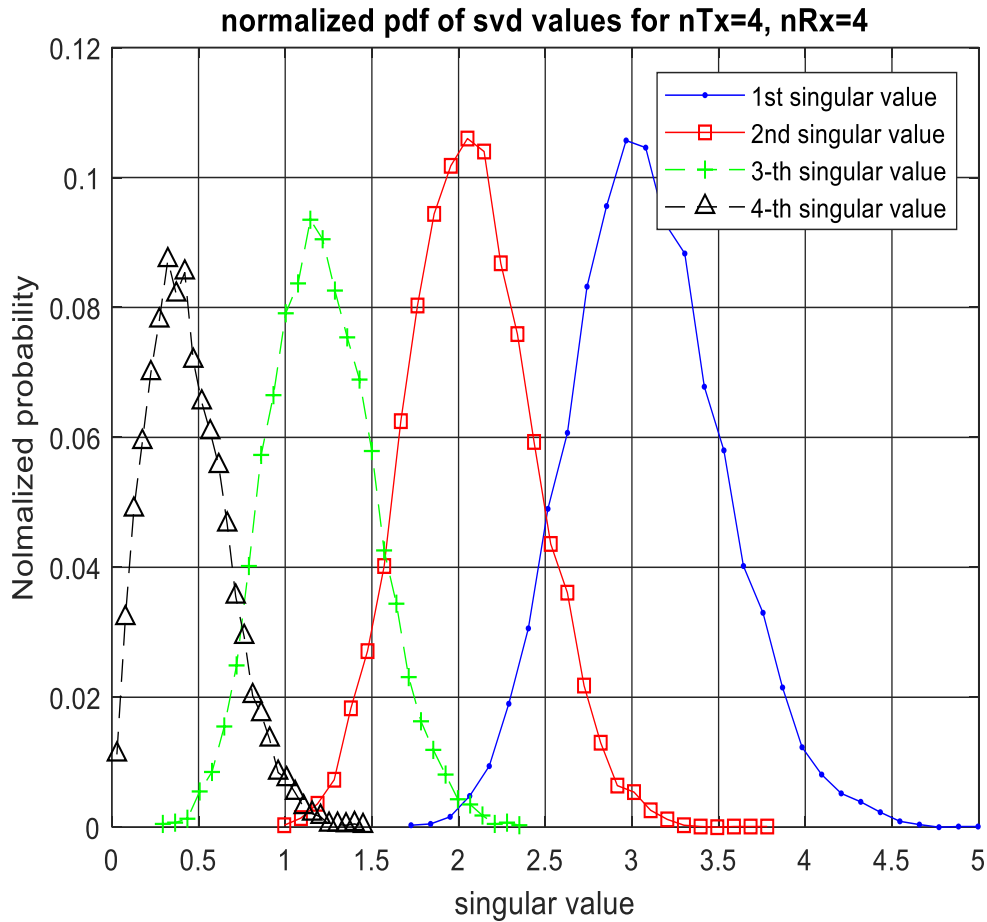

Figure 21 : normalized pdf of svd values for n Tx=4,nRx=4

3. BER Performance of MIMO Alamouti in different modulation schemes:

In the simulation BER VS SNR(E_b/N_0) for different modulation schemes in a Alamouti transmit diversity system under a Rayleigh channel is shown. Here, BPSK, 8-PSK, 16-QAM and 64-QAM modulations are this. From the simulation it can be seen that BER performance in lower modulation scheme is

better than higher modulation schemes. This happens simply because higher modulation schemes do carry more bits per symbol (higher throughput), but results in a very high BER. For example, BPSK modulates one whereas 8-psk modulates three bits per symbol. 6- QAM modulates 4 bits per symbol whereas 64-QAM uses bits per symbol.

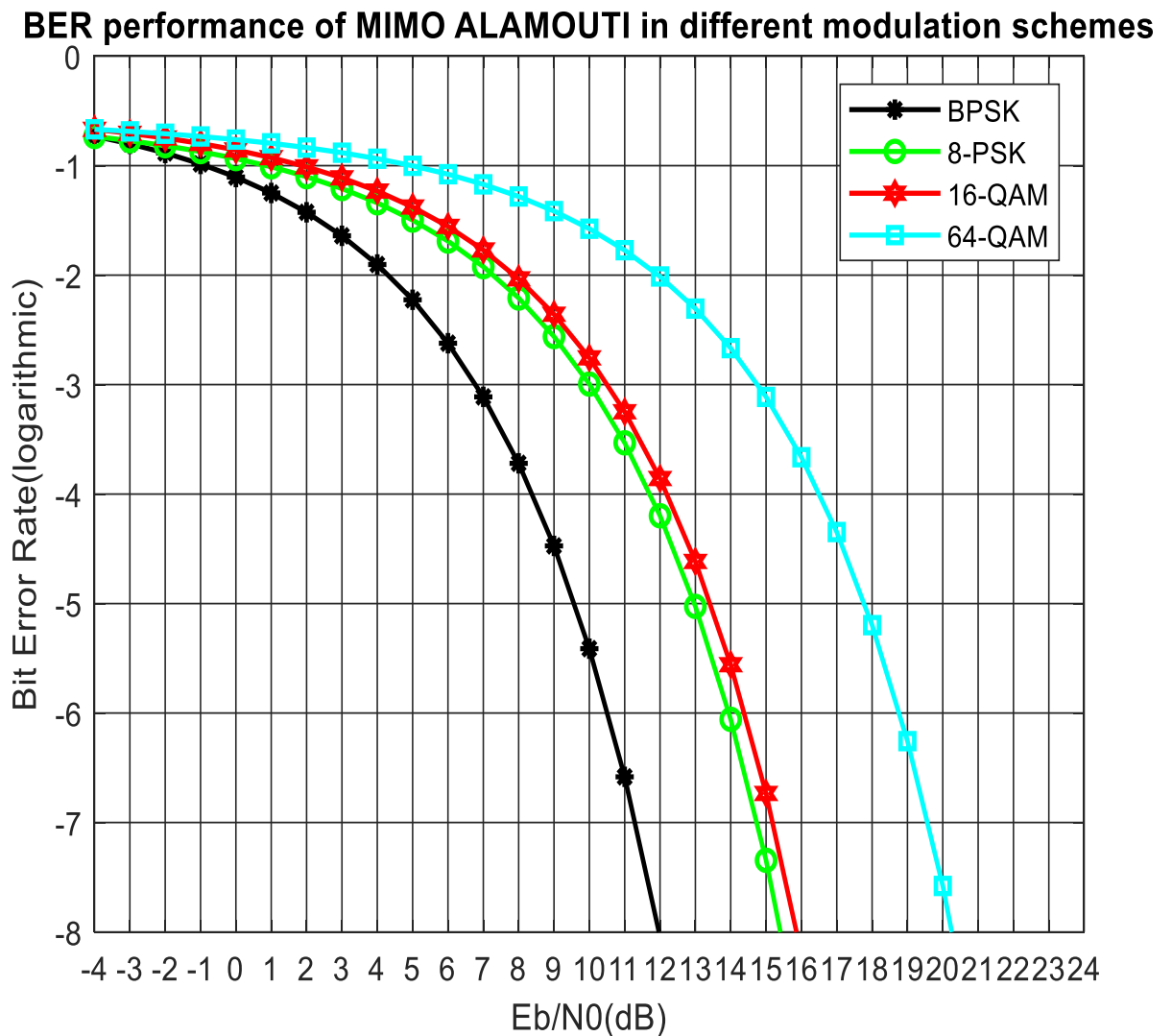

Figure 22: BER performance of MIMO Alamuti in different modulation Schemes.

Conclusion and future work:

Conclusion:

In this paper we have evaluated the performance of cognitive internet of things network using MIMO systems. The system parameters that are studied here are bit error rate and channel capacity. In a Rayleigh fading channel; we have implemented the Alamouti STBC scheme with a viewpoint of increasing the bit performance. We have also studied the effect of MRC on the system. Later water filling algorithm was proposed to ensure proper power allocation on the sub channels. Capacity for different orders of transmitter receiver systems was also evaluated.

The key features of our work are summarized below:

1. Increasing the number of Tx and Rx antenna can improve channel capacity. But increasing number of Tx antenna can result in more bit error due to inter symbol interference and increasing receiver antenna can result in complex and costly channel estimation process.
2. Alamouti scheme can reduce BER by reducing inter symbol interference at the Tx side. However MRC for the receiver side shows better performance in BER reduction.
3. Combining the effect of STBC and MRC results in the best possible bit performance.
4. If channel state information is known at the transmitter side, MRC can be used to improve bit performance but if it is not available, only using STBC is more desirable cause increasing receiver antenna with no CSI leads to complex channel estimation.
4. Water filling algorithm ensures proper power allocation in subchannels thus help to improve the capacity of the system.
5. Water filling algorithm and singular value decomposition does not change the basic characteristics of MIMO; which is ‘ increasing the number of transmitter-receiver antennas improves channel capacity.’

6. Higher order modulation schemes brings in more throughput but also yields in more bit errors. So the system designer has to design the system in a balanced way where both throughput and BER are desirable for users by choosing a particular modulation schemes.

Future work:

1. Throughout this paper it was assumed that the transmitter knows the channel information. So in future STBC with unknown CSI at the transmitter needs to be investigated. Also the channel estimation and detection process related to this process should be studied.

2. In this paper the effect of water filling on various sub channels with known CSI alongside STBC was evaluated. For unknown CSI only a mathematical model for capacity was discussed .In future the impact of water filling with unknown CSI at the transmitter on sub channels and STBC should be looked at.

3. There are some other popular methods available to improve the channel throughput; such as OFDM or MIMO-OFDM system. Combining the effects of STBC with these methods can lead to a better performance; which needs to be investigated.

4. If the transmission channel is way too noisy; singular value decomposition sometimes might not be effective as most of the bandwidth is not going to be allocated and bandwidth can remain idle; so this situation needs to be asserted

References

- [1] A. Paulraj, R. Nabar and D. Gore, "Introduction to Space-time Wireless Communications", Cambridge university Press. 2003.
- [2] Gregory D. Durgin, "Space-time Wireless Channels", Prentice Hall PTR. Pearson Education, Inc. 2003.
- [3] B. Vucetic, J. Yuan, "Space-time Coding", John Wiley & Sons Ltd, England. 2003.
- [4] Erik G. Larsson and P. Stoica, "Space-time Block Coding for Wireless Communications", Cambridge University Press. 2003.
- [5] J.C. Guey, M.R. Fitz, M.R. Bell, and W.Y. Kuo, "Signal Design for Transmitter Diversity Wireless Communication Systems Over Rayleigh Fading Channels," IEEE Transactions on Communications, Vol. 47, No. 4, pp. 527-537, April 1999.
- [6] J. H. Winters, "Diversity Gain of Transmit Diversity in Wireless System with Rayleigh Fading,". IEEE Transactions, Vol. 47, pp. 119-123, 1998
- [7] G. W. Wornell and M. D. Trott, "Efficient Signal Processing Techniques for Exploiting Transmit Antenna Diversity on Fading Channels", IEEE Transactions on Signal Processing, Vol. 45, pp. 191-205, 1997.
- [8] W. Y. Kuo and M. P. Fitz, "Design and Analysis of Transmitter Diversity Using Intentional Frequency Offset for Wireless Communications,". IEEE Transactions, Vol. 46, pp. 871-881, 1997.
- [9] V. Tarokh, H. Jafarkhani, and A.R. Calderbank, "Space-time Block Codes from Orthogonal Designs," IEEE Transactions on Information Theory, Vol. 45, No. 5, pp. 1456-1467, July 1999.

- [10] S.M Alamouti, "A simple Transmitter Diversity Scheme for Wireless Communications", IEEE Journal on Selected Areas in Communications, Vol. SAC-16, pp. 1451-1458, October 1998.
- [11] S. H. Nam, J. Chung, C. Hwang, and Y. Jung, "Differential Space-time Block Codes using Non-constant Modulus Constellations for Four Transmit Antennas", IEICE Transactions on Communications, Vol. E88-B, No. 4, April 2005.
- [12] B. M. Popovic, "New Complex Space-time Block Codes for Efficient Transmit Diversity", IEEE 6th International Symposium On Spread-Spectrum Tech & Applications, Sept. 6-8, 2000.
- [13] H. Jafarkhani, "A quasi-orthogonal Space-time Block Code, " IEEE Transactions on Communications, Vol. 49, No. 1, pp. 1-4, January 2001.
- [14] H. Jafarkhani, "Space-Time Coding: Theory and Practice", Cambridge University Press, 2005.
- [15] V. Tarokh, N. Seshadri and A. R. Calderbank, "Space-time Codes for High Data Rate Wireless Communication: Performance Criterion and Code Construction", IEEE Transactions on Information Theory, Vol. 44, No. 2, pp. 744-765, March. 1998.
- [16]. Daniel Perez Palomar, Member, IEEE, and Javier Rodriguez Fonollosa, Senior Member, IEEE, "Practical Algorithms for a Family of Waterfilling Solutions", IEEE Transactions On Signal Processing, Vol.53, No.2, pp: 686-695 Feb 2005.
- [17] J. Yang, E. Masood and Y. Sun, "Performance of Space-time Block Coding Using Estimated Channel Parameters", London Communications Symposium Conference UCL, 2004.
- [18] J. H. Winters, "Diversity Gain of Transmit Diversity in Wireless System with Rayleigh Fading, ". IEEE Transactions, Vol. 47, pp. 119-123, 1998

[19] W. C. Jakes Jr., Microwave Mobile Communications. Piscataway, NJ: IEEE Press, 1994

[20] Dig-Comm-Barry-Lee-Messerschmitt] Digital Communication: Third Edition, by John R. Barry, Edward A. Lee, David G. Messerschmitt.

Appendix :

Codes:

BER for BPSK modulation with Alamouti STBC and MRC:

```
clc;

clear all;
close all;

N = 10^6;
Eb_N0_dB = [0:25];
nRx = 2;
for ii = 1:length(Eb_N0_dB)

    ip = rand(1,N)>0.5;
    s = 2*ip-1;

    sCode = 1/sqrt(2)*kron(reshape(s,2,N/2),ones(1,2)) ;

    h = 1/sqrt(2)*[randn(nRx,N) + j*randn(nRx,N)];
    n = 1/sqrt(2)*[randn(nRx,N) + j*randn(nRx,N)];

    y = zeros(nRx,N);
    yMod = zeros(nRx*2,N);
    hMod = zeros(nRx*2,N);
    for kk = 1:nRx

        hMod = kron(reshape(h(kk,:),2,N/2),ones(1,2));
        hMod = kron(reshape(h(kk,:),2,N/2),ones(1,2));
        temp = hMod;
        hMod(1,[2:2:end]) = conj(temp(2,[2:2:end]));
        hMod(2,[2:2:end]) = -conj(temp(1,[2:2:end]));

        y(kk,:) = sum(hMod.*sCode,1) + 10^(-Eb_N0_dB(ii)/20)*n(kk,:);

        yMod([2*kk-1:2*kk],:) = kron(reshape(y(kk,:),2,N/2),ones(1,2));
```

```

hEq([2*kk-1:2*kk], :) = hMod;
hEq(2*kk-1, [1:2:end]) = conj(hEq(2*kk-1, [1:2:end]));
hEq(2*kk, [2:2:end]) = conj(hEq(2*kk, [2:2:end]));

end

hEqPower = sum(hEq.*conj(hEq),1);
yHat = sum(hEq.*yMod,1)./hEqPower;
yHat(2:2:end) = conj(yHat(2:2:end));

ipHat = real(yHat)>0;

nErr(ii) = size(find([ip- ipHat]),2);

end

simBer = nErr/N;
EbN0Lin = 10.^(Eb_N0_dB/10);
theoryBer_nRx1 = 0.5.*(1-1*(1+1./EbN0Lin).^(-0.5));

p = 1/2 - 1/2*(1+1./EbN0Lin).^(-1/2);
theoryBerMRC_nRx2 = p.^2.*(1+2*(1-p));

pAlamouti = 1/2 - 1/2*(1+2./EbN0Lin).^(-1/2);
theoryBerAlamouti_nTx2_nRx1 = pAlamouti.^2.*(1+2*(1-pAlamouti));

close all
figure
semilogy(Eb_N0_dB,theoryBer_nRx1,'bp-','LineWidth',2);
hold on
semilogy(Eb_N0_dB,theoryBerMRC_nRx2,'kd-','LineWidth',2);
semilogy(Eb_N0_dB,theoryBerAlamouti_nTx2_nRx1,'c+-','LineWidth',2);
semilogy(Eb_N0_dB,simBer,'mo-','LineWidth',2);
axis([0 25 10^-5 0.5])
grid on
legend('theory (nTx=1,nRx=1)', 'theory (nTx=1,nRx=2, MRC)', 'theory (nTx=2, nRx=1, Alamouti)', 'sim (nTx=2, nRx=2, STBC)');
xlabel('Eb/No, dB');
ylabel('Bit Error Rate');
title('BER for BPSK modulation with Alamouti STBC and MRC (Rayleigh channel)');

```

2. Average capacity of the MIMO system, CDF of the capacity and normalized probability of SVD values:

```

clc;
clear all;
close all;

numOfTxAntennas = [1 2 3 2 4];

numOfRxAntennas = [1 2 2 3 4];

noisePower          = 1e-4;
signalToNoiseRatio_dB = -10:3:20;

numOfIterations = 1e4;

curveType          = {'b.-'; 'rs-'; 'g+--'; 'k--^'; 'm--d'};

nOfAntennasVecTx = length(numOfTxAntennas);
nOfAntennasVecRx = length(numOfRxAntennas);
if nOfAntennasVecTx ~= nOfAntennasVecRx
    error('Vectors numOfTxAntennas and numOfRxAntennas must have the
same size')
else
    nOfAntennasVec = nOfAntennasVecRx;
end
if nOfAntennasVec < length(curveType)
    error('Number of elements in numOfTxAntennas must be smaller than
%d.', ...
        length(curveType))
end

signalToNoiseRatio          = 10.^(0.1*signalToNoiseRatio_dB);

nOfsignalToNoiseRatio      = length(signalToNoiseRatio);

CapacityVec                = ...
    zeros(nOfAntennasVec, nOfsignalToNoiseRatio, numOfIterations);

lambdaVec                  = ...

zeros(nOfAntennasVec, nOfsignalToNoiseRatio, numOfIterations, nOfAntennasVec);

for n = 1 : nOfAntennasVec
    nTx = numOfTxAntennas(n);
    nRx = numOfRxAntennas(n);
    for j = 1 : nOfsignalToNoiseRatio
        snr = signalToNoiseRatio(j);
        txPower = noisePower*snr;

        for i = 1 : numOfIterations

```

```

        h = 1/sqrt(2)*(randn(nRx,nTx)+1i*randn(nRx,nTx));

        S = svd(h);

        lambdaVec(n,j,i,1:min(nRx,nTx)) = S;

        cnr = S.^2/noisePower;

        allocatedPower = waterFilling(cnr,txPower);

        capacity = sum(log2(1+allocatedPower.*cnr));

        CapacityVec(n,j,i) = capacity;
    end
end
end

CapacityVecAvg = mean(CapacityVec,3);

f1 = figure(1);
clf
legendStr = cell(nOfAntennasVec,1);
for n = 1 : nOfAntennasVec
    plot(signalToNoiseRatio_dB,CapacityVecAvg(n,:),curveType{n})
    hold on
    legendStr{n} = sprintf('nTx = %d, nRx = %d',...
        numOfTxAntennas(n),numOfRxAntennas(n));
end
xlabel('SNR [dB]')
ylabel('Capacity [b/s/Hz]')
grid on
title('Avg Capacity of a MIMO system for different num of tx-rx
antennas')
legend(legendStr,'location','best')

f2 = figure(2);
clf
targetSNRdB = 5;
Ind = find(signalToNoiseRatio_dB == targetSNRdB);
for n = 1 : nOfAntennasVec
    capacities = CapacityVec(n,Ind,:);
    [y,x] = hist(capacities(:),30);

    y = y ./ sum(y) ;
    plot(x,cumsum(y),curveType{n})
    hold on
end
xlabel('Capacity [b/s/Hz]')
ylabel('Probability of Capacity < GivenCapacity')
grid on
title(sprintf('CDF of the Capacity at SNR = %ddb',targetSNRdB))
legend(legendStr,'location','best')

n = 5;
nTx = numOfTxAntennas(n);
nRx = numOfRxAntennas(n);
f3 = figure(3);

```

```

clf
legendStr = cell(min(nTx,nRx),1);
for k = 1 : min(nTx,nRx)
    lambdas = lambdaVec(n,Ind(:,k));
    [y,x] = hist(lambdas(:),30);

    y = y ./ sum(y) ;
    plot(x,y,curveType{k})
    hold on
    if k == 1
        legendStr{k} = '1st singular value';
    elseif k == 2
        legendStr{k} = '2nd singular value';
    else
        legendStr{k} = sprintf('%d-th singular value',k);
    end
end
end
ylabel('Normalized probability')
xlabel('singular value')
legend(legendStr)
grid on
title(sprintf('normalized pdf of svd values for nTx=%d,
nRx=%d',nTx,nRx))

```

3. Power allocation for waterfilling algorithm:

```

clc;
clear all;
close all;
Trans_Power=10;
Noise_Power=[2 3 4 1 3 4 3 2];
Number_Channel= length(Noise_Power) ;
[S_Number dt]=sort(Noise_Power);
sum(Noise_Power);
for p=length(S_Number):-1:1
    T_P=(Trans_Power+sum(S_Number(1:p)))/p;
    Input_Power=T_P-S_Number;
    Pt=Input_Power(1:p);
    if(Pt(:)>=0),
        break
    end
end
Allocated_Power=zeros(1,Number_Channel);
Allocated_Power(dt(1:p))=Pt;
Capacity=sum(log2(1+Allocated_Power./Noise_Power));
for ii =1:length(Noise_Power)
    g(ii,:)=[Noise_Power(ii),Allocated_Power(ii)];
end
bar(g, 'stack');
legend ('Noise Level','Power Level','')
ylabel('Noise & Power Level','fontsize',12)
xlabel('Number of Channels (N)','fontsize',12)
title('Power Allocation for Waterfilling Alogorithm','fontsize',12)

```

4. BER Performance of MIMO Alamouti in different modulation schemes:

```
clc;
clear all;
close all;
EbN0dB = -4:1:24;
EbN0lin = 10.^(EbN0dB/10);
colors = {'k -*', 'g-o', 'r-h', 'c-s',};
index = 1;

BPSK = 0.5*erfc(sqrt(EbN0lin));
plotHandle= plot(EbN0dB,log10(BPSK),char(colors(index)));
set(plotHandle,'Linewidth', 1.5);
hold on;
index = index+1;
m = 3;
M = 2.^m;
for i=M;
    k=log2(i);
    berErr = 1/k*erfc(sqrt(EbN0lin*k)*sin(pi/i));
    plotHandle= plot(EbN0dB,log10(berErr),char(colors(index)));
    set(plotHandle, 'Linewidth', 1.5);
    index = index+1;
end

m = 4:2:6;
M = 2.^m;

for i=M
    k=log2(i);
    berErr = 2/k*(1-1/sqrt(i))*erfc(sqrt(3*EbN0lin*k/(2*(i-1))));

    plotHandle= plot(EbN0dB,log10(berErr),char(colors(index)));
    set(plotHandle, 'Linewidth', 1.5);
    index = index+1;
end

legend ('BPSK', '8-PSK', '16-QAM', '64-QAM');
axis( [-4 24 -8 0] );
set (gca, 'XTick', -4:1:24);
ylabel('Bit Error Rate(logarithmic)');
xlabel('Eb/N0 (dB)');
title('BER performance of MIMO ALAMOUTI in different modulation schemes');
grid on;
```

