

**STRUCTURAL STRENGTHENING OF SETTLEMENTS  
IN THE COASTAL AREAS OF BANGLADESH**



A Dissertation for the Degree of Master in Disaster  
Management

By  
**Tahmina Rahman**  
Student ID: 07268010

**Fall 2008**

Postgraduate Programs in Disaster Management (PPDM)  
BRAC University, Dhaka, Bangladesh

## **ACKNOWLEDGEMENT**

First I would like to thank my teachers, especially Dr. Fuad Hassan Mallick, Mohammad Aminur Rahman and Khondaker Hasibul Kabir for helping me in so many ways in the dissertation. I thank Dr. S. I. Khan for indirectly helping to refine my thoughts. Their guidance has been immense in focusing my ideas.

I thank all the staffs of Brac office of Sarankhola Branch, especially Rashedul bhai, Najma apa, Ratan bhai, Tapan bhai and Latif bhai (Morrelganj Branch). Their help has been great during the field visit to understand the practical situation. I thank my classmate Rahat for taking me to the field visit.

Big thanks to Bappi for taking the trouble in composing all the diagrams, and giving the mental support through thick and thin. And I thank my families, the one where I was born and the one I made later. Basically they are my batteries.

# Table of Contents

## ACKNOWLEDGEMENT

## ABSTRACT .....

<b>1. INTRODUCTION</b> .....	<b>1</b>
1.1 BACKGROUND .....	1
1.2 HYPOTHESIS/ RESEARCH QUESTION .....	7
1.3 RATIONALE .....	8
1.4 OBJECTIVES .....	9
1.5 METHODOLOGY .....	9
1.6 LIMITATIONS .....	12
<b>2. CHARACTER OF THE STUDY AREA</b> .....	<b>13</b>
2.1 SELECTION OF THE STUDY AREA .....	13
2.2 GEOGRAPHICAL AND ENVIRONMENTAL SETTINGS .....	14
2.2.1 LOCATION .....	14
2.2.2 LANDSCAPE .....	17
2.2.3 RAINFALL AND SOIL .....	17
2.3 NATURAL HAZARDS .....	18
2.3.1 CYCLONE .....	18
2.3.2 SALINITY .....	18
2.3.3 WATER LOGGING .....	18
2.3.4 EROSION .....	18
2.3.5 TSUNAMI .....	18
2.4 SOCIAL AND ECONOMIC SETTINGS .....	19
2.4.1 OCCUPATION .....	19
2.4.2 WEALTH RANKING .....	19
2.4.3 HEALTH .....	20
2.5 SETTLEMENT PATTERN .....	20
2.5.1 OVERALL PLANNING OF THE DWELLINGS .....	20
2.5.2 HOMESTEADS .....	21
2.5.3 MAIN HOUSE .....	23
2.6 OTHER COMPONENTS IN THE BUILT ENVIRONMENT .....	27
2.7 EXISTING UTILITIES .....	29
2.7.1 TRANSPORT SYSTEM .....	29
2.7.2 POWER SUPPLY .....	29
2.7.3 WATER SUPPLY .....	30
2.7.4 ENERGY FOR COOKING .....	30
2.7.5 PHONE NETWORK .....	31
2.8 DEPENDENCY ON NATURE .....	31
2.9 SWOT ANALYSIS OF THE AREA .....	32
2.10 SCOPE OF THE RESEARCH .....	33
<b>3. CASE STUDIES AND LITERATURE REVIEW</b> .....	<b>35</b>
3.1 GENERAL CRITERIA FOLLOWED IN THE STUDY .....	35
3.2 RELIEF HOUSES AT SARANKHOLA .....	35
3.2.1 RELIEF HOUSE BY BRAC ( Chouchala House ) .....	36

3.2.2 RELIEF HOUSE BY BRAC ( Dochala House ) .....	40
3.2.3 RELIEF HOUSES BY ISLAMIC DEVELOPMENT BANK .....	41
3.2.4 RELIEF HOUSES BY DANCHURCHAID .....	42
3.3 HOUSE AT SUBARNACHAR IN NOAKHALI .....	45
3.4 DESIGN AND CONSTRUCTION GUIDELINES BY ADPC .....	49
3.5 DESIGN PARAMETERS BY HOUSING CLUSTERS AFTER CYCLONE NARGIS.....	53
3.6 COMMUNITY BASED DISASTER SHELTERS IN ORISSA, INDIA .....	58
3.7 CYCLONE SHELTER BY BRAC .....	60
<b>4. STRUCTURAL STRENGTHENING OF SETTLEMENTS .....</b>	<b>66</b>
4.1 RURAL SETTLEMENT PATTERNS AND CHARACTER .....	66
4.2 CONCEPTUAL FRAMEWORK .....	<b>68</b>
4.3 VULNERABILITIES AND CONSTRAINS IN PLANNING .....	70
4.4 LAND USE AND PLANNING .....	71
4.4.1. LAND USE PRACTICE .....	71
4.4.2 IMPROVEMENT OF SETTLEMENT CLUSTERS .....	74
4.4.3 ROAD NETWORK .....	75
4.4.4 LOCATION OF AMENITIES/ UTILITIES .....	76
4.5 HAZARD RESISTANT/ RESILIENT HOUSE .....	77
4.5.1 SINGLE FAMILY HOUSE .....	77
4.5.2 LARGER HOUSE AS SAFE HAVEN FOR NEIGHBORS .....	<b>85</b>
<b>Hypothetical Design</b> of a Large <b>House as safe haven</b> : .....	87
4.6 SAFE BUILDINGS .....	<b>89</b>
4.5.1 CONSIDERATIONS FOR CONSTRUCTION OF PERMANENT STRUCTURES .....	<b>89</b>
4.6.2 COMMUNITY BASED CYCLONE SHELTER .....	92
<b>Hypothetical Design</b> of a Community <b>Based Cyclone Shelter</b> .....	95
4.6.3 NGO OFFICE AS CYCLONE SHELTER/ SAFE HAVEN .....	97
4.6.4. SCHOOL AND MADRASSA .....	<b>98</b>
<b>Hypothetical Design</b> of a School: .....	99
4.6.5 MOSQUE .....	100
4.6.6 KILLA .....	101
4.6.7 GRAIN STORAGE WAREHOUSE .....	101
4.7 LANDSCAPING .....	<b>103</b>
4.7.1 COMMUNITY POND/ <b>SOURCES OF DRINKING WATER</b> .....	<b>103</b>
4.7.2 COMMUNITY LANDSCAPING .....	<b>104</b>
4.7.3 TREE PLANTATIONS .....	<b>105</b>
4.7.4 AFFORESTATION .....	<b>106</b>
4.8 CRITICISM .....	<b>108</b>
4.9 RELATIONSHIP WITH OUTSIDE AND INSIDE PARTICIPATIONS .....	109
4.10 RECOMMENDATIONS .....	109
<b>5. CONCLUSION .....</b>	<b>112</b>
<b>REFERENCE .....</b>	<b>114</b>
<b>APPENDICES .....</b>	<b>120</b>
APPENDIX A .....	120
APPENDIX B .....	122
<b>Glossary .....</b>	<b>126</b>

## List of Maps

MAP OF STORM SURGE .....	3
MAP OF CYCLONE TRACK .....	4
MAP OF POTENTIAL SOURCE OF TSUNAMI .....	5
MAP OF SEISMIC ZONINGS OF BANGLADESH .....	6
MAP OF KHUNTAKATA UNION .....	15
MAP OF SARANKHOLA UPAZILLA WITH KHUNTAKATA UNION .....	16
SUGGESTED CHANGES IN THE UNION .....	73

## List of Architectural Drawings

TECHNICAL DETAIL OF FOUNDATION .....	47
TECHNIQUES OF MAKING PLINTH STRONGER AGAINST EROSION .....	49
TECHNIQUES OF MAKING POSTS STRONGER .....	50
HOUSE DESIGN BY MYANMAR ENGINEERING SOCIETY (MES) .....	55
HOUSE DESIGN BY UN-HABITAT .....	56
HOUSE DESIGN BY REAM .....	57
PLANS OF CYCLONE SHELTER BY BRAC .....	61
PLANS OF CYCLONE SHELTER BY BRAC .....	62
ELEVATIONS OF CYCLONE SHELTER BY BRAC .....	63
ELEVATIONS OF CYCLONE SHELTER BY BRAC .....	64
HYPOTHETICAL DESIGN OF A LARGE HOUSE AS SAFE HAVEN .....	87
HYPOTHETICAL DESIGN OF A COMMUNITY BASED CYCLONE SHELTER .....	95
HYPOTHETICAL DESIGN OF A SCHOOL .....	100

## List of Sketches

DISPERSED SETTLEMENT IN THE LOCALITY .....	20
ARRANGEMENT OF ELEMENTS IN A COMMUNITY .....	74
GRADUAL ADDITION OF FORMS IN A TYPICAL HOUSE STRUCTURE .....	79
LATERAL WIND FORCE ON WALL .....	81
SUCTION FOR UNEQUAL WIND PRESSURE .....	81
ROOF CONSTRUCTION DETAILS .....	83
LOCATION OF COMMUNITY POND AND KILLA .....	103
PROCEDURES OF PLINTH PREPARATION .....	122
CROSS BRACINGS ON THE FRAMES .....	123
PROPERLY NAILED C I SHEET ROOF .....	124
BRACINGS IN ROOF FRAME .....	124
APPROPRIATE ROOF SLOPE AND SHAPES CONSIDERING WIND LOAD .....	125

## List of Figures

LANDSCAPES OF THE LOCALITY .....	17
APPROACHES OF HOMESTEADS .....	21
KITCHENS, COW SHED AND CHICKEN COOP .....	22
DIFFERENT KINDS OF HOUSE STRUCTURES .....	24
COMPONENTS IN A TRADITIONAL HOUSE .....	25
BUILT ENVIRONMENT OF THE LOCALITY .....	28
TRANSPORT ROUTES IN THE LOCALITY .....	29
WATER SUPPLY AND BATTERY POWERED LIGHT .....	30
BRAC RELIEF HOUSE (CHOUCHALA TYPE) .....	37
BRAC RELIEF HOUSE (DOCHALA TYPE) .....	40
1DB RELIEF HOUSE .....	41
HOUSE CONSTRUCTIONS BY DANCHURCHAID GRANTS .....	42
PROCESSES CARRIED IN THE HOUSE CONSTRUCTION AT SUBARNACHAR .....	46
DISASTER SHELTERS BY SDC .....	58
CONSIDERATIONS TO CHECK IN ROAD NETWORK .....	75
HOUSE FRAME ON STILTS .....	80

## List of Flowcharts

FLOWCHART OF THE METHODOLOGY .....	11
FLOWCHART OF SCOPE OF THE RESEARCH .....	34

**List of Tables**

DESIGN PARAMETERS FOR HOUSING CLUSTER ..... 54  
SPECIFICATIONS OF MES DESIGN ..... 55  
LOCAL GOOD PRACTICES IN DESIGN AND TECHNICAL METHODS USED ..... 108  
TECHNOLOGIES AND METHODS THAT MAY BE INTRODUCED ..... 108

**List of Pie Charts**

OCCUPATIONAL DISTRIBUTION OF THE AREA .....19

## **ABSTRACT**

The coastal areas of Bangladesh are prone to cyclone disasters for the geographical, economic and environmental background. It is recognized that Bangladesh will be adversely affected by climate change effects with more frequent and intensified cyclones. The loss and damages occurred from such disasters are hard to overcome for a developing country like this. Considering the context mitigation cannot be practical solution, but adaptation may be the feasible option to deal with future disasters.

Strengthening the coastal settlements physically to reduce vulnerability can be a means of adaptation solution. This may be achieved by building/ repairing dwelling houses with integration of local good practices and implemented engineered techniques, and available sustainable materials; so the damages of assets and physical environment can be reduced. Improving community facilities like road network, community based cyclone shelters, strong schools and hospitals etc, strong houses to act as community refuge can upgrade the quality of the built environment focusing on disaster risk reduction. This approach may be carried with the physical developments of the locality, rather than in the reconstruction phase after every disaster; so the resilience of communities is increased and risks are reduced.

# 1. INTRODUCTION

## 1.1 BACKGROUND

Bangladesh is a natural disaster prone country for its unique geographical location and environmental settings. Cyclone, salinity, erosion etc are the common hazards, and tsunami a potential hazard of the coastal areas. With the increase of the climate change effect and climate variability these hazards will pose more threats to the region. It may be presumed that this region may face new hazards like coastal flooding, water logging, harsher Al Nino effect etc for the excessive upstream flow and the sea level rise in the future. The changed fluvial pattern for the increased snow **melt in** the Himalayas will also shape the nature and the hazards of this region. Apart from these the coastal area falls under earthquake hazard according to the seismic zonings of Bangladesh. Earthquakes occur in infrequent intervals in this country. Though the past damages had not been recorded thoroughly, the Great Indian Earthquake in 1897 with a value of 8.7 in Richter scale caused severe damages in the northern districts and minor damages throughout the country (Ali, M. H. and Choudhury, J. R. nd, in Nizamuddin, K, 2001). These existing and potential hazards affect the life pattern, settlements, environment and economy of the region.

Many parts of the coastal regions of the country had been protected by embankments constructed during the 1960s. But these cannot solely act to safeguard life and property against disasters. These were constructed mainly to protect the inland from tidal floods of the sea. The increase of population growth, fishing in the bay and deltas, change of land use practice, increase demand for paddy production, shift of agricultural practice like the cultivation of melon, peanuts etc in the sandy soils of the coastal areas have encouraged more habitations in this region. These habitations with investments in different sectors create pressure on the resources of this region when a natural disaster occurs.

Cyclone is a major hazard of the coastal areas of the country and often causes loss of life, and economic loss and damage. As this is a high impact rapid onset disaster, the damages occurred are often hard to overcome and manage. From the historical data it was seen that in 1584 about 200,000 people were reported to have been killed in Barisal and Patuakhali districts in storm surge by cyclone; in the last 100 years a total of around 75 cyclonic storms have hit the Bangladesh coast, of which 40 have been



classified as severe cyclonic storms (Choudhury, J. R, 2008). This hazard zone covers about 16% area of the total country. According to the Multi Purpose Cyclone Shelter Program (BUET-BIDS, 1993) the projected population of the potential affected area would be 6.35 million and 8.26 million in the years 2002 and 2017 respectively. The geographical location of the country in the tropical zone, the 720 km coastline with basically no natural barriers except the Sundarbans, the low topography, and the funnel shape of the north of the Bay of Bengal make this area vulnerable to cyclones. Furthermore the general economic condition of the inhabitants here is poor, and the infrastructure is not strong enough to resist strong wind and surge load. As fishing in the bay is a good source of livelihood in terms of quick economic return, the saline water encourages shrimp cultivation, and formation of islands in the bay near the mainland attracts more migration, it is obvious that more people will inhabit in this large hazard prone area in the future.

Weather forecasting and early warning system have improved a great deal in the country with Bangladesh Meteorological Department (BMD) and the dedicated volunteering of Cyclone Preparedness Program (CPP). With many cyclone shelters built in the potentially vulnerable coastal areas, Bangladesh has been able to minimize human deaths in catastrophic cyclones. An example is the cyclone SIDR of November 2007 which was a category 4 cyclone and one of the strongest one in the Bay of Bengal region considering the wind speed (265 km/ hr), where human death was 3,406 (MoFDM, 2008). But previously death was catastrophic in such strong cyclones. For example, reported 300,000 deaths (unofficially 500,000) in the 1970 cyclone and 140,000 in the 1991 cyclone. But property, livestock, crops and other movable and immovable resources of the affected area are always adversely damaged in such disasters. For example, it was estimated by the government that the total loss and damage caused by cyclone SIDR was BDT 113 billion or USD 1.6 billion, the housing sector suffered BDT 55.7 billion or 49% of this (MoFDM, 2008). It is predicted that with climate change the frequency and intensity of cyclones will increase in this region.

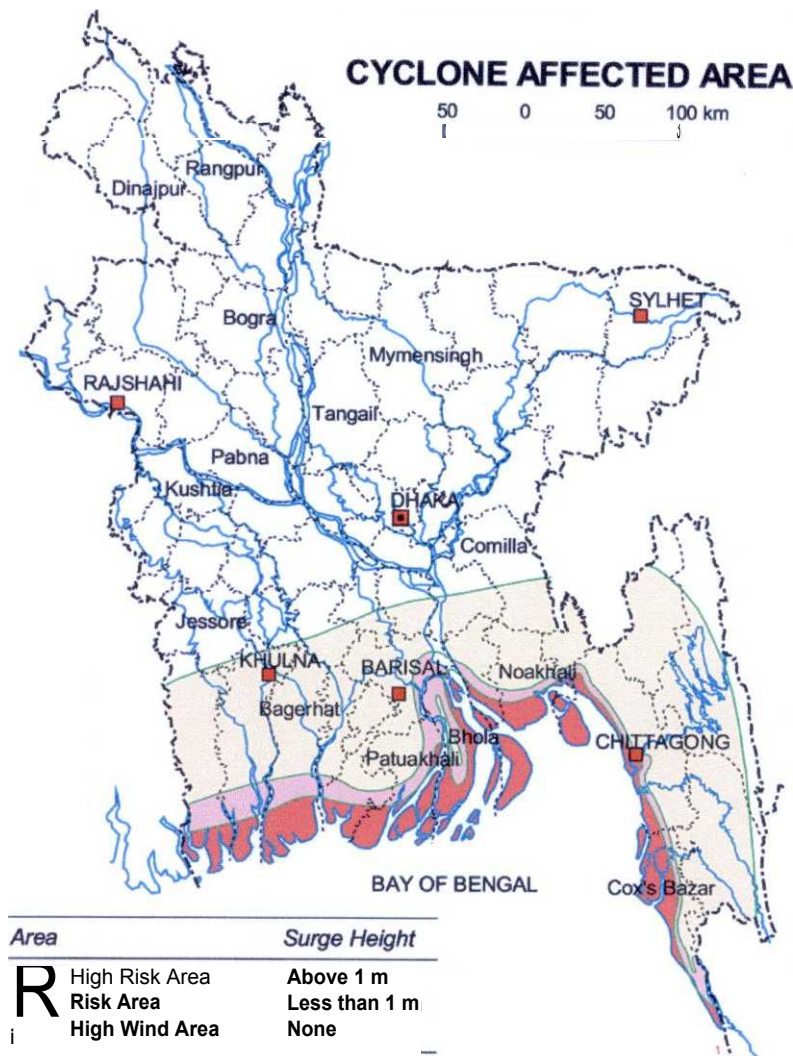

1: Map of storm surge (source: Banglapedia)

Cyclone shelter construction is expensive and sometimes these are far away from the settlements. This requires large budget allocations and foreign aid. Many shelters do not have any use at normal times, the maintenance cost of these are also a burden on the authority. Furthermore these shelters are not under the sole guardianship of any authority. For example some of these are under Public Works Department (PWD), some under Bangladesh Red Crescent Society (BDRCS), some under Facility Department of Ministry of Education, some under Local Government Engineering Department (LGED), and some are constructed and maintained by NGOs like Brac, Grameen, Caritas etc (BUET-BIDS, 1993). Many shelters face damages in erosion and salinity. So building new cyclone shelters considering large catchment area and

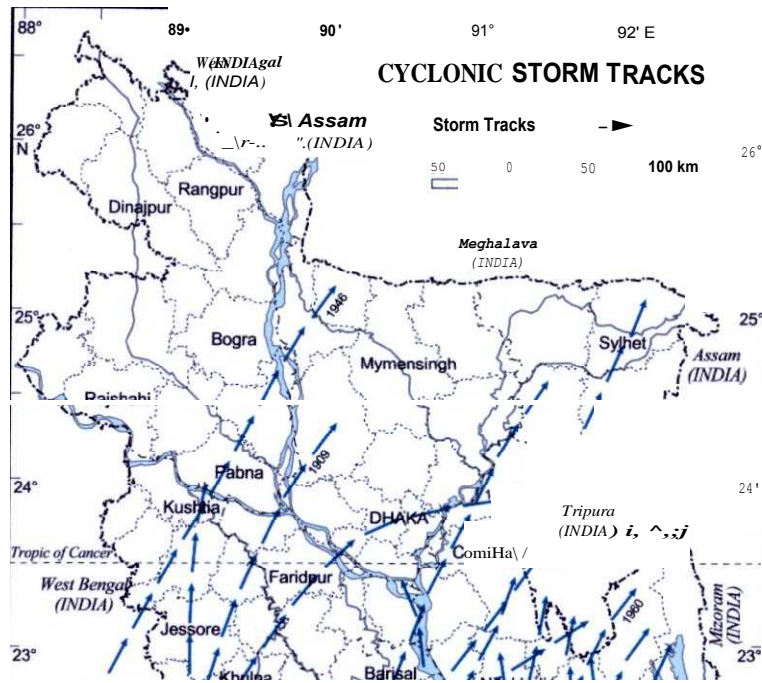

11

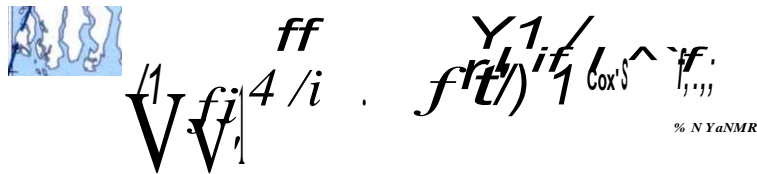

01

1

2'

2: Map of cyclone track (source: **Banglapedia**)

the growing population although necessary may not be a feasible alternate for the future. At present there are about 2,400 shelters in high risk areas; three million people were evacuated and 1.5 million accommodated to these shelters during cyclone SIDR (MoFDM, 2008). But many areas are without shelters leaving people vulnerable.

Furthermore females and elderly members often feel discouraged to move to cyclone shelters for security reasons. Also only people can take refuge in cyclone shelters in emergency time, and they sometimes have to leave behind their movable belongings, livestock etc. which get destroyed, damaged or stolen after the disasters (Tasneem, S and Chaudhury, M, 2007). This often makes people reluctant to move to shelters. But strong houses in the risk area can act as safe refuge during disaster and be cost

effective in terms of permanent living place. An example of it is the investigations done by IUCN (Mallick, F. H, *et al*, 2007, unpublished) at Shubarnachar in Noakhali by helping people make strong houses in "Building for Safety" approach; so the houses as components may face less damage and save assets during disasters.

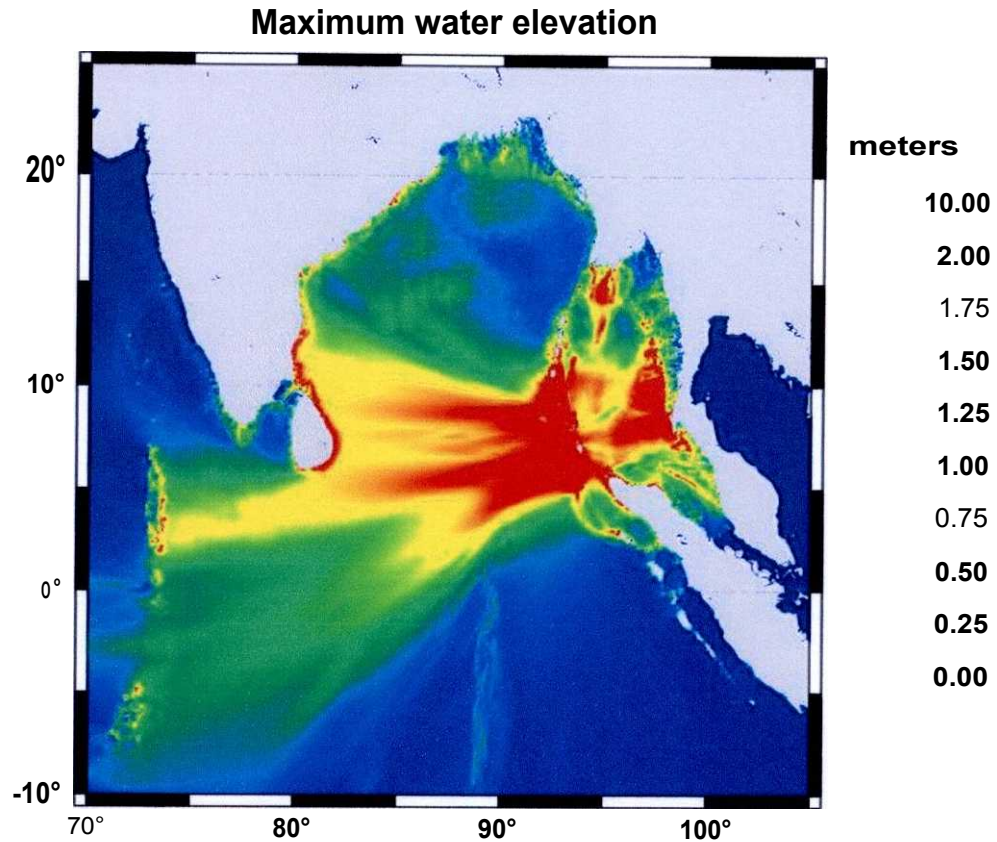

3: Map of potential source of **tsunami** (source <http://tsun.sccc.ru/20041226mod.htm>)

Apart from cyclone, tsunami has been identified as a potential hazard of the coastal region. Though people were unaware of this, the evacuation warning throughout the country on 12th September 2007 made them understand that they are under a new threat. The perception of it is not clear to them as are cyclones that can be predicted from overcast sky, gusty wind and rain.

Tsunamis are rare events in Bay of Bengal. From records of the past 250 years, it has been observed that the sources of tsunamis in the coast of Bangladesh are the tectonic plates near the Andaman and Nicobar Islands, India and Sumatra, Indonesia (Choudhury, J. R, 2008). It may be assumed from the records that Bangladesh will be affected by only the tidal waves and not the earthquake occurring from it. The different approaches to save lives and livestock in cyclones can be applicable for tsunami.

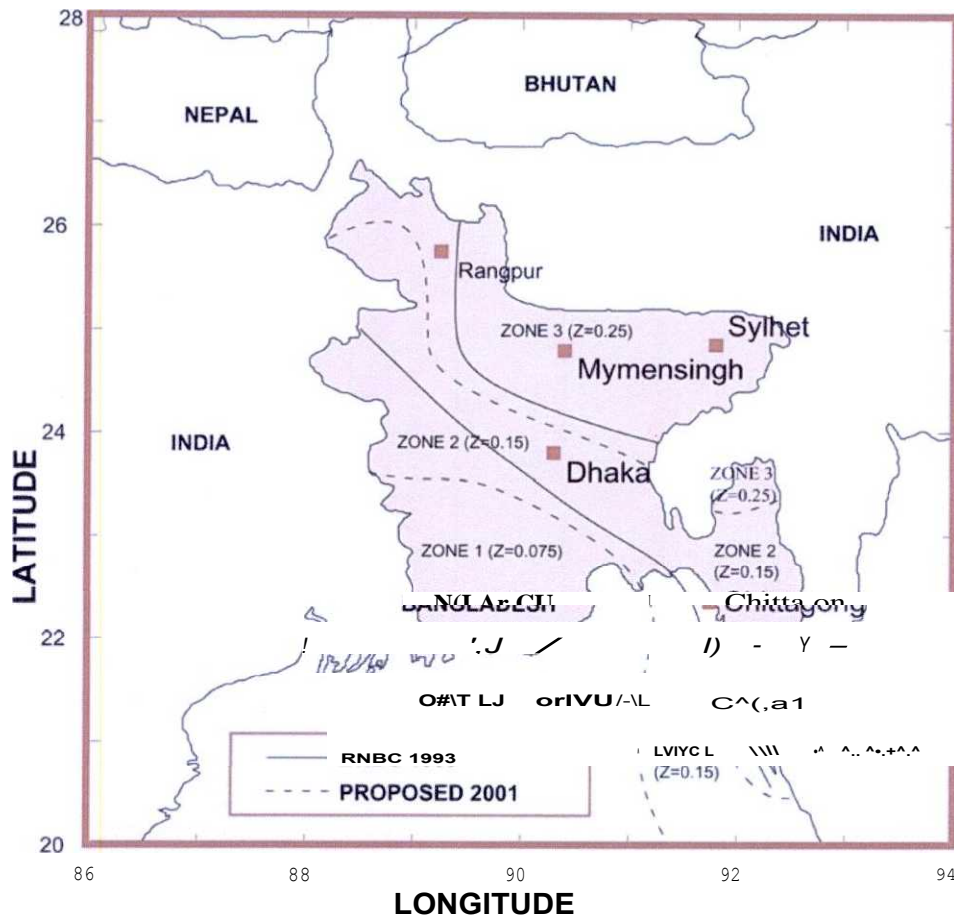

4: Map of seismic zonings of Bangladesh

## **1.2 HYPOTHESIS/ RESEARCH QUESTION**

Based on the potential hazards of the region and the disaster mitigation approach of "Building for Safety" that has been suggested in the IUCN report (Mallick, F. H, *et al*, 2007, unpublished) the hypothesis of this dissertation is that "the structural strengthening of communities as a cluster is a better alternative to long term development and resilience". The improvement of buildings, roads, sites etc were considered as the background for the research. Here it was explored if the human settlements in the hazardous coastal areas can be made structurally stronger with an overall planning approach including designing and detailing of the different usable units, improving traditional and engineering techniques, landscaping with mounds and water channels, plantations within the settlement etc. As cyclone is considered to be the major hazard here, it was more highlighted in the planning aspects, but the other hazards were considered as well. The sustainable use and management of materials with sustainable development of the region were explored in the study.

**Investigations were made to see if the community serving organizations like mosques, schools, NGO offices etc in the settlement can serve as refuge place for the inhabitants and their belongings during disasters; and if inclusion of smaller structures like strong houses or community based shelters can safeguard people in the event of severe cyclones and tidal surges. Then people may not have to move to larger cyclone shelters and they may remain in the surrounding environment taking care of their assets. As community based disaster preparedness is very strong in the country as a consequence of social structure, the settlement improving approach can be taken as a community based disaster risk reduction approach. This will encourage the inhabitants to maintain the quality of the infrastructural and natural environment for their own benefit. This in the long run, may encourage the participatory approach of the inhabitants to integrate traditional building techniques with formal engineering techniques.**

### *1.3 RATIONALE*

Natural disasters cause interruptions to development. Often funds for development need to be relocated to cover disaster damages and to make defenses against disasters. The reconstruction investment sometimes exceeds the regular development cost. The recurrences of hazards keep some regions neglected in development aspects. This increases the poverty level of the area and makes people more vulnerable to disasters (IEG, The World Bank, 2006).

The physical infrastructural development of a region integrated with economic sustainability make it much stronger to fight against hazards, and to restart life quickly afterward. Appropriate interests in the needed sectors in the initial stages will lessen the cost of rebuilding, increase the lifespan of structures and help maintain the quality of the environment. It has been explored that *"The implementation to simple modifications to improve the cyclone resistance (non masonry) kutca or temporary houses in Bangladesh is only five percents of the construction costs"* (Benson, T. et al, 2007 in Hodgson, R.L.P et al, 1996 in Lewis, J. and Chisholm, M. P, 1996).

Rebuilding after disasters to restart life is a natural tendency of man. The building/ strengthening activities make them aware of the potentials and limits of their resources. This helps in the psychological boosting or development of people (Rahman, A, 2004) and helps in the process of ownership. The participatory approaches reduce the gap between different stakeholders to understand the situation from their own self interest, so the gap between outsiders and insiders in the development/ rebuilding is reduced.

The rationales of the research are:

- There will be less damage of properties for structurally stronger settlements.
- Dependency of larger cyclone shelters in the time of disasters will be reduced.
- The quality of rural built environment will improve.
- This approach will work as a community based disaster reduction approach.
- The participatory approach of inhabitants will be encouraged which will help to integrate the traditional building technique and formal engineering technique.

## **1.4 OBJECTIVES**

The aim of the research is not to design a product or suggest a finished end product, but to design the process to carry it. The project focuses on some ways and means to implement the idea; but it is not restricted on the physical plan in actual sense. The solutions provided may be one of the options, but not "the solution" or an absolute solution. There is freedom to design and define one's own space.

The objectives of the research are:

- To investigate the physical feasibility of structural strengthening of settlements as a whole entity with its surroundings with topography in the coastal area to minimize the damages of assets and resources.
- To investigate the scope of improvements of the indigenous construction techniques in the traditional houses considering wind and surge.

## **1.5 METHODOLOGY**

The methodology to carry the study was to select a small settlement of community as a typical study area with typical hazards pattern from the southern coastal region and investigate the implementations of the objectives. The steps to carry these were as follows:

### **Literature Review:**

- Collection of data of the selected study area through secondary sources- literature review to analyze the potential hazards and the effects, population, living pattern, livelihood, livestock population, settlement pattern, data concerning the existing built environment, transport routes, possible help sources during disaster, existing other resources etc.
- Case study and literature review of different house building/ strengthening activities, guidelines; and other infrastructural developments aiming at disaster risk reduction carried out by different authorities concerning similar hazards, economic and environmental backgrounds.
- Analyze the studies in terms of merits and demerits with respect to the scope of research in the related context.
- Study rural settlement planning. Relate it with the present situation and future development of the study area. .



### **Field Survey**

- Field survey of the study area through observation, interviews and questionnaire survey. The target group of the survey were the permanent settlers, who are familiar with the natural hazards and the coping techniques considering constructions, environmental protections etc. Interviews were open ended with structured questionnaire.
- Analysis of the settlement pattern and its dependency with nature (for example, livelihood, energy supply, communication, use of natural material for construction etc).
- Identification of the strengths, weaknesses, opportunities and threats of the settlement.
- Identification of local good practices followed there in terms of building construction, planning, orientation, afforestation etc.

### **Design Approach**

- Suggest an improved plan for the case study settlement emphasizing on the hazard resilience and adaptation approach. Integrate roads and different built infrastructure to strengthen this quality, and include the existing resources of the settlement in the overall plan as much as possible.
- Suggest improvement of the individual units/ components in the traditional dwelling houses to make these more hazard resistant.
- Integrate the community based organizations and strong houses to act as safe havens in the time of disasters.

## Time Frame

- Field visit in the study area was done during the rainy season in August. During this time different organizations were constructing and distributing relief houses to the recipients whose houses got damaged in the SIDR cyclone. This was an opportunity to practically survey the house building techniques and search for options concerning the local context.

**Case studies** of house building/ strengthening activities by different authorities concerning hazards, especially wind and surge damages; similar works carried out that covers the research topic. Analyze the merits and drawbacks of these.

**Literature review**  
To understand about **natural** hazards, **population**, livelihood, **settlement**, **existing built** environment, **livestock etc of the settlement in the coastal region**

Analyze **the scope** of the thesis, study settlement planning.

**Discussions, interviews, questionnaires**

**rV**

**Initial field survey** to understand about the study settlement area, observations, **interviews, discussions etc.**

**K**

**In depth field survey** to analyze the settlement pattern and dependency with nature like **energy** supply, use of local **material in construction etc.**

**Literature review, expert opinion etc**

Seek **the local good practices** in terms of construction, maintenance, planning, **aforestation etc.**



**Plan of the structural strengthening of the settlement** as a community

**Design to improve individual units**

**1: Flowchart of the Methodology**

## **1.6 LIMITATIONS**

Some of the limitations in the research are as follows:

- The contour map of the study area was not consulted in the planning process. It was observed from the field visit that large portions of the region remain submerged under water most of the year. The natural topography is very crucial in the development of a region. But this has been ignored; only an idea of overall planning has been suggested.
- Solutions were suggested only for the typical study area. This may not match with all localities and settlements of the coastal belt. It was observed that different factors like employment pattern, social pattern and geographical character influence shaping of a settlement. Different settlements will have different planning approaches according to the unique characters.
- Economic development of settlements was not considered.
- Interest was given in the research to protect the life and assets of a community as much as possible. But all the resources cannot be fully protected. For example the standing crops cannot be protected from hazards, though damages may be reduced.

## **2. CHARACTER OF THE STUDY AREA**

### **2.1 SELECTION OF THE STUDY AREA**

The study area is Khuntakata (or Khontakata) union of Sarankhola upazilla. This place has some general features of the coastal areas like the deltaic landscape, typical hazards, wealth ranking, livelihood, quality of construction, distribution of government infrastructural facilities etc. There are also some unique characters like the Sundarbans at the south which is a natural barrier, lowland topography, thick tree coverage inside the settlements etc.

Bagerhat was one of the four worst affected districts in cyclone SIDR of November 15th 2007, where human loss and property damage was particularly severe. There were 810 reported deaths in Bagerhat, the second worst in the cyclone; and 118,899 houses totally damaged, which was the worst (MoFDM, 2008). Sarankhola suffered most of the damage with Dublar Char and Southkhali taking most of the blow.

Though there were no human casualties at Khuntakata, many inhabitants got wounded in the strong wind and storm surge. There was significant destruction and damage of houses, livestock, trees, crops, livelihood tools like boats and fishing nets, infrastructures like roads, embankments, boat terminals etc and the overall environment was damaged as saline water reached far into the mainland.

**The inhabitants here have experience of local cyclones usually in the pre monsoon period of April- May. But as cyclone SIDR occurred in post monsoon period, they were unprepared for it. Moreover, the strong implementation of the tsunami warning of 12th September 2007 had put a negative effect in their minds. As the tsunami and the cyclone warnings were forecasted within a two months gap, many took it as another false warning and did not take required precautions.**

## ***2.2 GEOGRAPHICAL AND ENVIRONMENTAL SETTINGS***

### **2.2.1 LOCATION**

Sarankhola upazila with an area of 756.61 square km (Banglapedia) is located in Bagerhat district of Khulna division. It is bounded by Morrelganj upazila of Bagerhat on the north, the Bay of Bengal on the south, Mathbaria upazila of Pirojpur and Patharghata upazila of Barguna district on the east at the other side of Baleswar river, and Mongla upazila of Bagerhat on the west. The main rivers of this upazilla are Baleswar, Haringhata, Chandpai and Bhola. The Sundarbans cover the major portion of this upazila at the west and south sides under Sarankhola range.

The southern most human habitation of Sarankhola is Southkhali (or Soudkhali), also known as Dakshinkhali. Sarankhola range lies at the south of it and Baleswar river is at the east of it. Though the Bay of Bengal lies at the south of Sarankhola range, the human habitation has only Baleswar river at the east as water boundary; the region does not directly fall to the exposure of the Bay.

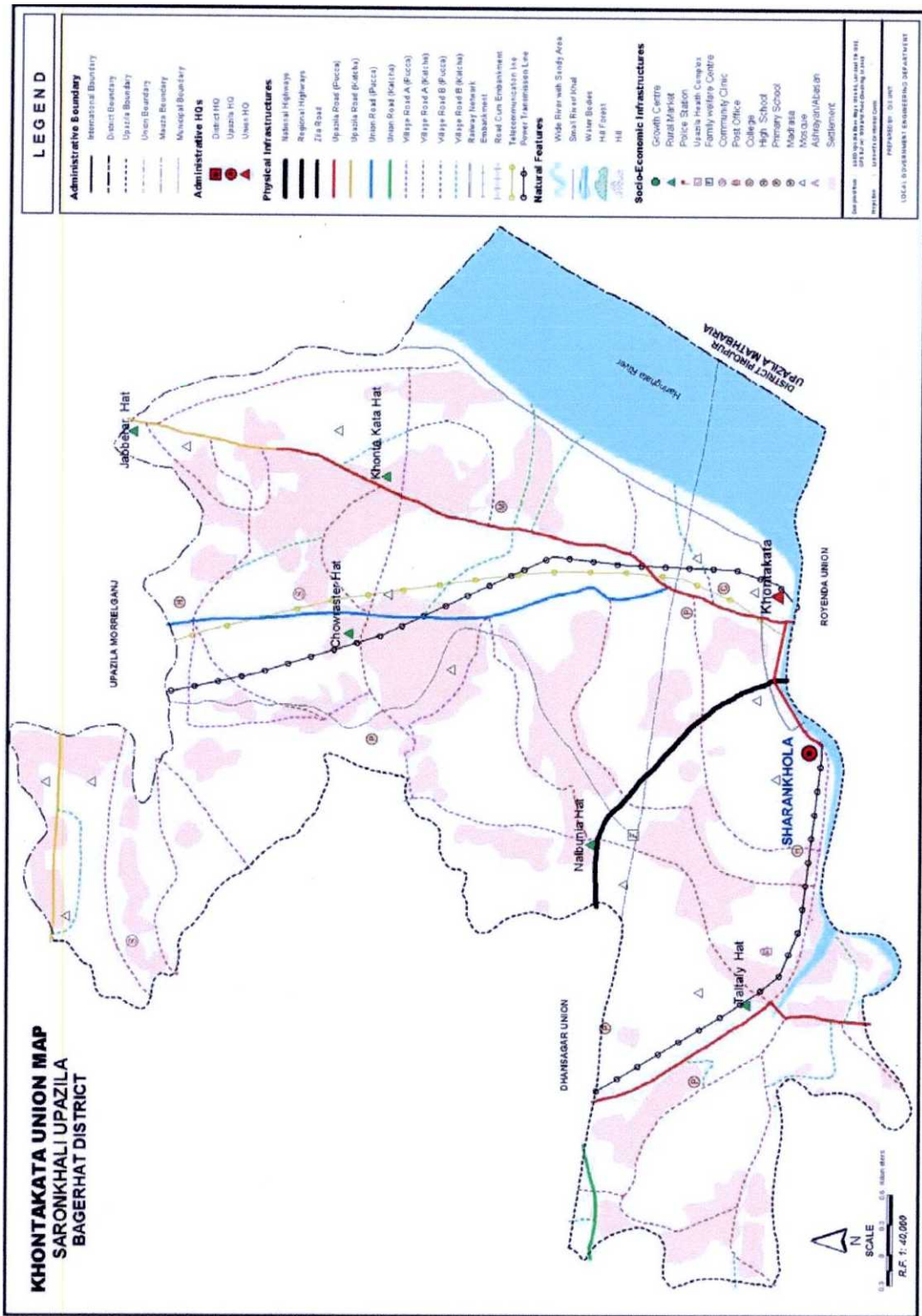

5: Map of Khuntakata union (source : LGD, LGRD)



6: Map of Sarankhola **upazila** with Khuntakata **union** (source: Banglapedia)

### 2.2.2 LANDSCAPE

The landscape of here has similarity with the Sundarbans forest landscape. The common landscape is muddy lowlands submerged in water most of the year and small channels running between these. There are natural canals that carry river water inland. It may be assumed from the landscape that this place was part of the larger forest in the past.



Higher grounds have roads, homesteads etc



lowlands **in water is used** for fishing mostly

1: Landscapes **of the** locality

### 2.2.3 RAINFALL AND SOIL

Wet season at Sarankhola is long. The soil is saline for the underground saline water. The climatic condition is good for trees to grow. Vast amount of timber and fruit trees grow here. But the salinity makes crop production difficult. Common agricultural productions are banana, betel leaf, betel nut and some vegetables. The land is not suitable for rice. The inhabitants cultivate rice with rain water stored in low lands and water from **canals** through channels.



## **2.3 NATURAL HAZARDS**

### **2.3.1 CYCLONE**

The major hazard of Khuntakata is cyclone. The inhabitants have faced cyclones with strong wind in the past, but they do not recall the effect of storm surge. This could be as Khuntakata lies in the north, away from the mouth of Baleshwar river and at a distance from the sea. The effects of cyclone here is not like that in the immediate coastlines or the offshore islands.

### **2.3.2 SALINITY**

The underground water is saline for the proximity of sea. This makes significant effect in the living condition. This has increased for the construction of a canal in Bholia river to reduce navigation route. During the wet season the flow of the upstream rivers and sufficient rainfall keep the salinity low. But in the dry season, especially in February- April period this increases for the backflow of sea water in the rivers, the reduced upstream flow and less rainfall.

### **2.3.3 WATER LOGGING**

As the landscape has large low lying terrains, water logging occurs in some places during heavy rainfall. It happens occasionally when river water is trapped inside inland in dry season for the backflow of sea.

### **2.3.4 EROSION**

As the region is beside the Baleshwar river, parts of the bank face erosion. This loss of land was helping to make a large island at the middle of the river that fell under another upazila. The locals informed that every year some houses of the bank are lost in erosion. Large portion of the bank was damaged in the storm surge of cyclone SIDR.

### **2.3.5 TSUNAMI**

As the coastal area of the country is generally considered to be under tsunami hazard, this area also falls under this criterion. During the first tsunami warning in the country disseminated in 12`x` September 2007, people had to evacuate to safer places.

## 2.4 SOCIAL AND ECONOMIC SETTINGS

### 2.4.1 OCCUPATION

According to the information from the inhabitants, about 60% of population is engaged in agriculture, about 30% in fishing and the rest in collecting forest products. Very few are van rickshaw drivers, day laborers, shop keepers, craftsmen etc. Basically the occupations depend on the seasons. The landless are engaged in agriculture in the harvesting season and fish during the rainy season. The proximity of river that has both fresh water and sea fish makes fishing a major occupation. Hilsha, different varieties of shrimp, shrimp fry etc are mainly caught. Forest products include wood, *golpata*, *hogla*, honey etc. People rear cow, goat and poultry. The livestock population was greatly damaged in SIDR cyclone. It was observed during the field visit that the inhabitants received these as relief material from many NGOs like Brac, Rupantar etc.

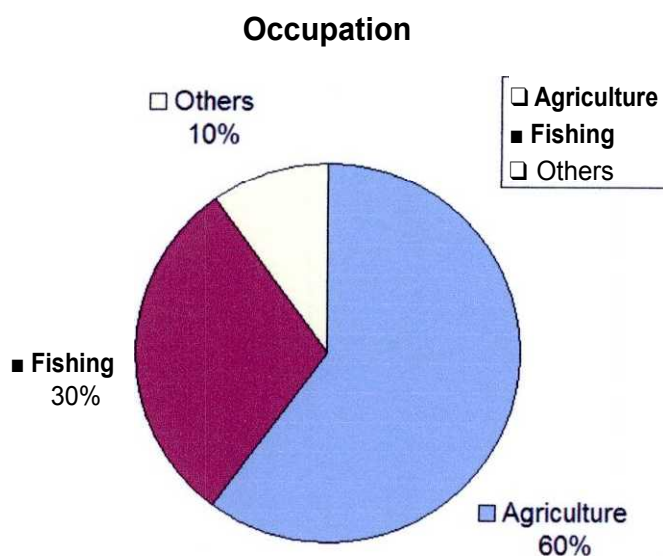

1: Occupational distribution of the area

### 2.4.2 WEALTH RANKING

In wealth ranking status almost all the inhabitants are poor. This can be judged from their daily income, daily calorie intake or condition of house. This is a common situation in the southwestern regions of the country. But initiatives have not been undertaken by government or other organizations to improve this. Recently after SIDR cyclone, many activities have been undertaken by the government, NGOs and

many organizations to repair the damages of the locality through relief and rehabilitation activities.

### 2.4.3 HEALTH

The overall condition of health is not good. This is mostly for scarcity of drinking water, spread of water borne diseases, malnutrition, lack of awareness, natural hazards and damp weather effect. There are many disabled persons in families, caused by malnutrition mostly.

## 2.5 SETTLEMENT PATTERN

### 2.5.1 OVERALL PLANNING OF THE DWELLINGS

The neighborhood concept is not very apparent here. The inhabitants live separately in context of space from one another. This could be influenced by the fact that most of them are poor and do not have any common property to share or protect.

Settlement pattern is dispersed. Most of the homesteads are scattered along the main *pucca* road but not immediately beside it; or along the internal *kutcha* narrow roads. These are not in clustered forms. Almost all of these are separate with distance from one another with water logged cultivated or fallow lands between that get dry in winter.

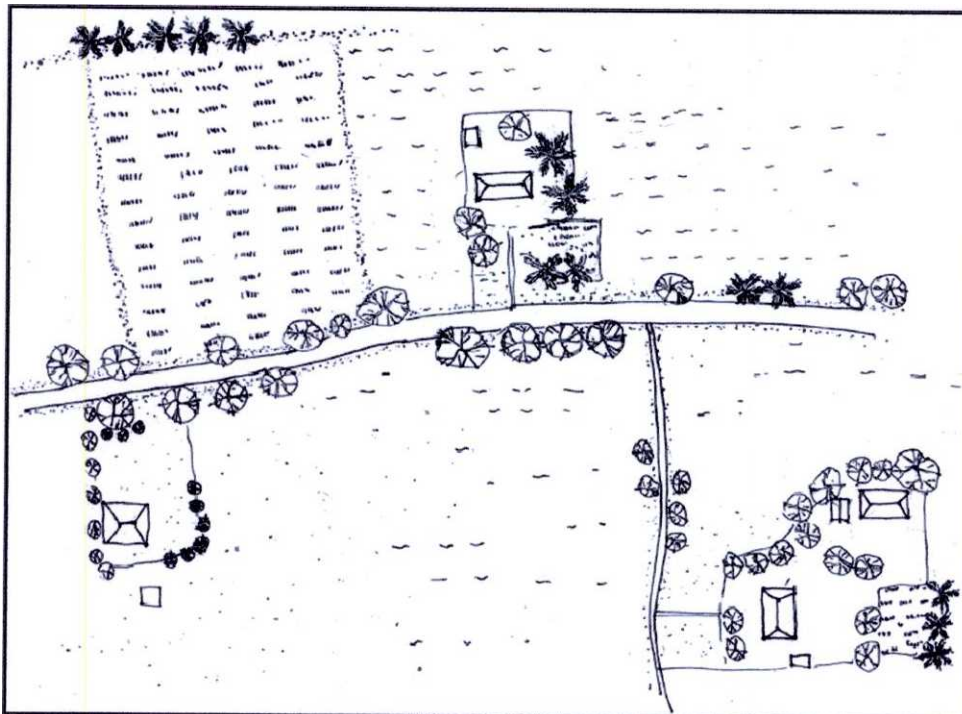

1: Dispersed settlement in the locality

The courtyard concept or settlements in raised mound to avoid flood or water logging is absent here. Few houses that are near each other do not share common spaces. The houses act as individual units and not as components of a larger group. This may be influenced from landscape with small amount of high land; or from environment to prevent wind pockets. It seemed from the interviews that the settlements are comparatively new there.

## 2.5.2 HOMESTEADS

Each of the homesteads is on higher ground or raised plinth from the surrounding. This plinth is made from carrying mud from the lowland; nothing is mixed to increase stability. The mud has a sticky character and gets quite hard when dry. Every year the plinth has to be repaired as the sides get damaged from hooves of cattle, rain and standing water.

The inhabitants grow lot of timber and fruit trees around the homesteads. These serve as firewood, provide shade and act as visual screens. They use dry date palm or betel nut leaves hanging from poles in the territory boundaries to act as screens. They are very particular about the visual screening of their homesteads.



Bridge of betel nut trunk in front of premise



Muddy path in front of house

### 2: Approaches of homesteads

If there is enough land, then vegetables are grown at the front where the land gets enough sun. Climbing plants like pumpkin, gourd etc are grown on hanging spread of unusable fishing **nets**. These are grown in the wet season when the land is muddy and submerged. So the land is used alternately and the nets are reused too.

As the main house is set quite at a distance from the approaching road, the inhabitants have to use betel nut or date palm trunk as bridges between the wetland in front of the houses and the approaching roads.



Mkok,  
Kitchen: straw roof; bamboo frame and straw



Kitchen: straw roof and mud walls



walls  
-0 |  
Cow shed: palm frond roof and wood frame; no walls



Chicken coop: *hogla* roof; wood, fishing net and polythene walls; mud plinth.

### 3: Kitchen, Cow shed and Chicken Coop

Kitchens, chicken sheds and cow sheds are at the side or the back of houses. These have *dochala* roofs; the slope is high to let rain water slide down but not soak. The walls, roof and plinth are made more economically. The chicken sheds are rectangular as it requires more space, mud plinth is raised. Often the cowsheds have wooden fenced walls for security, no plinths are provided.

It was found that each of the houses have separate toilets at the back of the main house. The government and different NGOs have played a significant role in distributing toilets to individual houses and encouraging the habit to use these. These are of bamboo mat or wooden walls, and thatch or wooden roof.

## 2.5.3 MAIN HOUSE

### a. Local Calculation Method for House Construction

The craftsmen use local calculation method in house construction to relate the usable space around them with body proportion. They take the local unit *haat* (equivalent to 18 inches) for calculation. They call it *bandho* or *bandhok* (could be meant as enclosure). They informed that this reduces wastage of materials, and improves the quality of usable space. The total of length and width of the floor area of the main house is selected to be an odd number like *17 bandhok*, *21 bandhok* etc. The length is taken as the odd number, like in a *17 bandhok* the length would be 11 *haat* and the width *6 haat*. If a verandah is used it would measure of odd number like *5 haat*'. If it is used in the sides, then it would be of the same width, like *5 haat* at the front and *5 haat* at the sides.

### b. Plinth

The houses face the south or the east. Each house **has a raised** mud plinth, some with **a small mud** wall like boundary around it to protect **the inner area** in case water floods the plinth. Nothing is mixed with mud. Clay steps may or may **not be in** front of the **entrance**.

<sup>1</sup> *Haat* in **Bangla word means hand**. The measuring unit *haat* indicates the length from **the end** of elbow to the tip of tallest finger; **it is equal to eighteen inches in British Standard Measurement** System.



*llogla* roof and wood wall



Straw roof and bamboo mat wall



C I sheet roof and wood wal I



C I sheet roof and wood wall



C I sheet roof and C I sheet wal I



Bamboo mat roof; polythene, wood and bamboo mat wall

**4: Different kinds of house structures**



Opening at the front, deep eaves in the roof

Mud plinth with boundary to protect against dampness; wooden posts on *pata*

### 5: Components in a traditional house

#### c. Walls and Frame

The main house has walls of wood, bamboo mat or C I sheet nailed with it. Often decorated wood work is curved in the walls. Mud walls are not used in the main house for torrential rain. Strong and durable timber is used as posts. Four main robust pillars are used at the corners, and inner pillars of lesser thickness are used with equal gaps; no cross bracing is used. The whole frame rests on a horizontal rectangular wooden frame at the bottom. This is made from more seasoned different kind of wood called *loha kath* collected from the lower trunks of trees from the jungle. The total house frame is not tied to the plinth, it rests upon it. Each pillar is placed on flat circular clay pottery like stands called *para*. The benefit of this is that the wood is not damaged by termites, infestation or dampness. Also in tidal surge, the large house structure does not get damaged; rather it is floated away to a distance. Later it is dragged back to the main location.

#### d. Internal Space Division

The internal space has only one room for smaller houses. Divisions are provided if the house is large enough. Usually one or two platforms are at the ceiling. These are used for sleeping or storing rice, seed rice, potteries etc.

#### e. Openings and Verandahs

The door is at the middle of the house. Doors and windows are at the south or east. At least one wall, usually the front has openings. The shutters open from inside the house. This helps the females operate these from inside without being seen from the outsider. This practice has been used from the past when fear of robbers was common,



so people could protect themselves from inside. Shutters are made of wood or flat metal plates, with or without wooden grills.

The houses may have verandahs at the front. In larger houses these may be at the sides according to need and financial ability. These are used as extension of rooms - for sitting in the shades, entertaining guests, sewing quilts, keeping goats and chicken at night etc. The inhabitants said that verandahs around the house reinforces it and resists strong wind load.

#### **f. Roof**

*Dochala, chouchala and atchala* roofs are used. Houses with smaller floor area are *dochala* or *chouchala*. Straw, *hogla, golpala, C I sheet* etc are used here.

An *atchala* roof is the combination of one *chouchala* roof surrounded by another. It is used in larger houses. These are two storied and usually have two *macha* (platforms) on the ceiling. The height of it at the center can be from 8.5 *haat* to 12 *haat*. Longer wood sections with less joins in a single member are used here. The eaves of the roof are extended to protect **rain and** sun. Affluent people or large families can afford this kind of house.

#### **g. Tying Materials**

Coconut rope is used in straw and other leaf constructions. Iron pegs, thin wires etc are used in C I sheet constructions. Nylon or jute rope is not used as it decays quickly. Small strips of C I sheet are used in wrapping different joints to make these stronger.

## ***2.6 OTHER COMPONENTS IN THE BUILT ENVIRONMENT***

The other constructions in the region are mosques, schools, madrasa, small tea and grocery shops, clusters of shops in the bazaar etc. These are beside the roads, unlike the settlements.

The Union Parishad building is the only three storied structure. There are no cyclone shelters or strong buildings that can be used during disasters.

There are very few one storied schools of brick and RCC construction. Some of the mosques, schools and madrasa are of brick wall and C I sheet roof. Most of these are of C I sheet walls and roof, and mud plinth. These are of linear type with long open verandah at one side. The tea stalls and grocery shops are basically large wooden boxes with *ekchala* or *dochala* C I sheet roof, and raised over the lowlands on wooden or date palm stilts.



## 2.7 EXISTING UTILITIES

### 2.7.1 TRANSPORT SYSTEM

The main transport system is through river in diesel engine trawlers and country boats. There is a ferry connection from Morrelganj to Rayenda.

*Pucca* road is very insufficient; a main thoroughfare connects Khuntakata with Rayenda extending inside the villages. Roads are raised from the surrounding landscape. Large timber trees like *Mehagani*, *Chambal*, *Babla*, date palm and palm trees are planted at both sides which help in retaining the soil.



Main thoroughfare with large trees



Most of the roads are muddy and *kutchha*.

#### 7: Transport routes in the locality

The internal roads are muddy and difficult to use; communities connecting with these are far from the river banks and the main road. Rickshaw vans, shallow engines with trolleys and few motor cycles are means of transport. A bus stop at Rayenda bazaar has services running as far as to Dhaka. Bus service has improved after the cyclone SIDR for increased communication regarding relief and rehabilitations.

### 2.7.2 POWER SUPPLY

Khuntakata gets electricity supply from the Rural Electric Board (REB); it is limited to very small area. The houses do not have electricity connection. The inhabitants use *kupi* or hurricane lamp. Some use a kind of lamp made with rechargeable battery and small flash light bulbs.



### **2.7.5 PHONE NETWORK**

The area has mobile phone connections. This was very useful after the cyclone SIDR in news dissemination and relief distribution except for the short time when power supply got disrupted immediately after the cyclone. Majority of people do not own mobile phones, but they can get access to it in the bazaar and news is disseminated by word of mouth.

### ***2.8 DEPENDENCY ON NATURE***

The life and livelihood of the inhabitants are dependent and harmonized with the nature. The main livelihoods agriculture, fishery and *bawali* are dependent on the seasonal changes and availability of the harvests.

Homestead pattern has evolved from the natural settings. Conditions that do not match with the surroundings are not imposed. People mostly use natural materials like *golpata*, *hogla*, palm leaf etc in house constructions. Use of wood as construction material is more compared to other places of the country. Firewood is the only mean of cooking fuel; kerosene, cow dung or jute sticks are not used.

Rainwater is used for drinking and agriculture. This is the only mean of fresh water as river water is slightly saline. Rain water is stored for agriculture with small mud boundaries around the land to restrict saline water inflow. River water is also used through canals.

## ***2.9 SWOT ANALYSIS OF THE AREA***

Some of the strengths of the region are:

- Proximity of the river makes it an important transport route and water source.
- Road communication with Dhaka and main large cities.
- Abundant tree coverage inside the settlements.
- Proximity of the Sundarbans as natural barrier.
- Abundant natural materials for house construction.
- Harmony with nature in lifestyle helps to retain the quality of environment.

Some of the weaknesses are:

- Dispersed neighborhood.
- Insufficient and poor road network.
- Many areas submerged under water.
- Not enough strong community based organizations. No strong large house to act as safe haven in disaster.

The opportunities from here can be:

- River route can be used in times of disaster when road networks get disrupted.
- As the area got focus after the SIDR cyclone, there have been a lot of rehabilitation activities in many aspects. This will help in reaching different solutions after trials and errors.

The threats of here can be:

- Proximity of the river makes it vulnerable to storm surge.
- Evacuation becomes difficult for poor roads and dispersed neighborhood.

## **2.10 SCOPE OF THE RESEARCH**

Disasters can be an opportunity of renewed development and background for new ideas. After a disaster drawbacks of developments are focused, and options can be searched from the possibilities. This is also experienced in the coastal areas after destructions from cyclones.

But observing the patterns of development, especially after the cyclone SIDR, it can be assumed that most of the development activities are carried out in isolated forms. There seems to be no visible cooperation or integrated planning concept concerning community developments among the different stakeholders like the government, donors, NGOs, and locals. A long term complete development strategy is missing here. A definite guideline in the infrastructural developments concerning the different authorities will be very helpful.

The Local Government Division under the Ministry of Local Government Rural Development and Co-operatives has the responsibility of infrastructural development like roads, bridges, growth centers; provision of amenities like safe drinking water, sanitation, electricity; mobilization of local resources (LGD, <http://www.lgd.gov.bd/html/about.html>). These are extended up to the grass-root level. But it lacks the authority of settlements planning with the government and private entities. It does not have the authority over the community based organizations, the different non government authorities working there. So it can be said that from disaster reduction approach, it does not play a vital role in the communities.

There are no set guidelines about how the infrastructures will integrate with the settlement planning in disaster mitigation approach. The Bangladesh National Building Code suggests guidelines for buildings to be safe against hazards and accidents. But unfortunately it cannot be monitored strictly.

There is no definite guideline from disaster reduction approach in the designs of community serving organizations like mosques, NGO offices etc so these can act as safe havens in disasters. There are design guidelines only for the construction of



government primary schools; the private and community schools, NGO schools, madrasa etc do not follow and fall under this.

An overall planning of settlements integrating all the social organizations for the benefit of the locals in disaster reduction approach will be positive in the long term development. Considering these points, it can be said that there is scope to work on ideas on the physical strengthening of the settlements in the coastal areas from disaster reduction aspect.

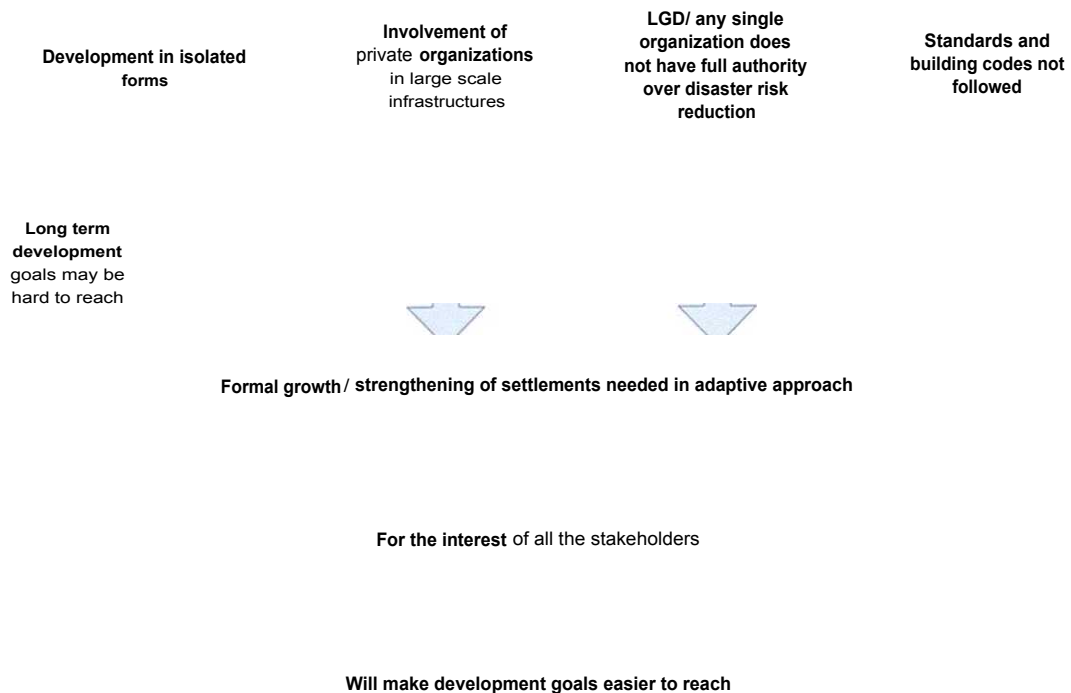

## 2: Flowchart of scope of the research

### **3. CASE STUDIES AND LITERATURE REVIEW**

#### **3.1 GENERAL CRITERIA FOLLOWED IN THE STUDY**

The case studies have been selected from literature reviews concerning similar hazard patterns, social and environmental contexts of different countries. Strong wind and storm surge have been considered especially, as the coastal areas are the most vulnerable to these.

Some studies were done on house constructions at Sarankhola while in field visit. These were distributed by different authorities as grants as part of rehabilitation program to SIDR affected people.

The house at Subarnachar, Noakhali is a study of the process of designing, reviewing alternatives and constructing a house with aspiration and affordability. The ADPC report covers different cost effective but durable techniques in design and construction of houses with available materials concerning flood. The Myanmar shelter cluster report covers design parameters of house construction set by the government and humanitarian agencies to meet the rehabilitation program after the Nargis cyclone. Criticisms on these were based on the users' opinions where possible, expert opinions and own judgment.

#### **A. CASE STUDIES**

#### **3.2 RELIEF HOUSES AT SARANKHOLA**

Sarankhola had been one of the worst affected regions of SIDR cyclone, with the maximum number of houses damaged. Different organizations were involved in house distribution as part of the second phase of rehabilitation activities like Brac, Care, DanChurchAid, Rupantar, Asray, **Islamic** Development Bank (IDB), Islamic Relief, Muslim Aid, Caritas, grants from Saudi Arabia and many other local and foreign NGOs. These houses have selected models chosen by the providers; floor space areas are more or **less same**; materials used are different in the different models that made budget differences. For example, houses distributed by Care and Saudi grants had thicker C I sheets and *pucca* plinths; the cost of these rose to 71,000 taka and 1,30,000 taka respectively with the highest budgets in the locality. Houses

distributed by Brac (two models), IDB and DanChurchAid have been selected as case studies from these models.

### **3.2.1 RELIEF HOUSE BY BRAC (*Chouchala* House)**

This house model has similarities in some extents with the experimental house of Subarnachar, Noakhali. But the basic structure has been customized in many parts to fit as a single model to be distributed as relief to the recipients.

- These houses are constructed and quality control supervised by Brac.
- The construction cost of each house is 47,000 taka; of which 4,000 taka is labor cost.
- Each house is of 15 feet by 10 feet, with a veranda of 15 feet by 5 feet at the front.
- It has a *chouchala* C 1 sheet roof over the main house, and an *ekchala* roofed verandah at the front. These two roofs are separate entities, joined with wooden members of separate frames.
- It has four RCC pillars of 4"x 4" and ten feet height at the corners. These pillars are embedded three feet below the plinth, and tied to a ten inch RCC base with two inch long two metal clamps, screws and nuts. These pillars are tied with the timber roof frame with twisted metal clamps, screws, nuts and metal wires. This technique is used only in the Brac houses but not in the other model houses. This is a new approach here.
- Mud plinth has low brick walls all around to protect against erosion in rain.
- The house has one door and two windows at the front.
- Walls are of bamboo mat treated with local oil varnish (Maitta oil).



The verandah at the front has four additional wooden pillars.



Cross bracings of wall frames are used outside on the shorter length of walls.



Metal angles, pegs and wires are used for joints. Jute or nylon ropes are not used as it decays in weather.

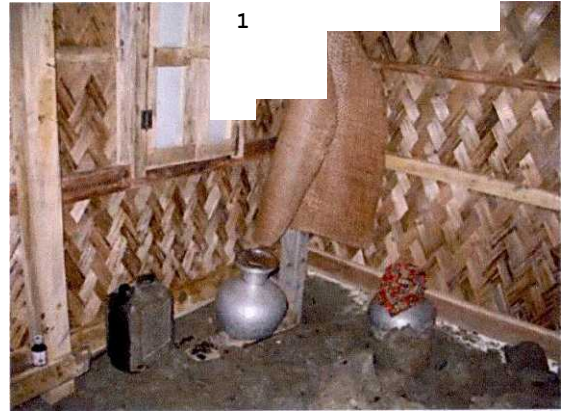

Four RCC pillars and six wooden pillars with metal clamps are used inside the house. Wooden frames are used in walls.



One platform above the head height provides extra space inside the house.



Verandah at the front is used as a quality space for domestic activities.

**9: Brac relief house (chouchala type)**

**Some of the positive aspects of the house are:**

- The RCC pillars with concrete base makes the house frame stronger against wind load. This will prevent damages against insect, dampness, salinity etc to the main pillars.
- The users thought the small house form in context of smaller size families is good for maintenance and repair. But they feared as the form has become smaller, it is possible to get blown away in strong wind. The strong RCC pillars would hold the house with the ground and prevent it from such damages.
- Cross bracings on the walls are new concept in the locality and taken very positively by the users and craftsmen. It is not used in the traditional rural houses or the other relief houses. The users thought that it will strengthen the walls from wind load.
- The roof slope is **lower than the slope** of the roofs made by **leaves**. This would **reduce wind load on it**.
- The C I sheet roof is **more durable and suitable** for collecting **rain water**.
- The verandah in the front is a good space for keeping goats and chickens at night.
- The use of brick walls around the mud plinth is a new cost effective approach that is not used in the traditional houses.
- The brick **and cement** finished front **steps are appreciated** by the users very **much**. According to them **this gives a character to the house**.
- The metal clamps for joints are a new approach in the locality. It encouraged the craftsmen to use in other constructions.

The drawbacks are:

- The users felt that if the verandah was wider, the usable space would be better. For example, if one person is saying his *namaaz* here, then another person cannot pass him undisturbed as the width does not allow it.
- The head height of the verandah is not enough to allow a person of regular height to walk inside the space with a sack on his head. This will create some difficulties in circulation during the harvesting season, as rice is stored inside the house.
- As the dwellers are familiar with the local *haat* unit, they feel unaccustomed with the inner space of the house as the measurements have changed here.
- As there is only one entry, this creates some problems in use.
- It can make more positive spaces if the users are allowed to add more elements like another verandah, semi covered room, rails in the verandah etc according to their needs. But the users are not allowed to.

### 3.2.2 RELIEF HOUSE BY BRAC (*Dochala House*)

This is an earlier version of relief house of Brac. This model was distributed before the new model was introduced.

- It has a *dochala* roof and an *ekchala* verandah at the front. The verandah roof is an extension of the main roof sharing the same frame.
- The floor areas of the both model houses are same.
- The construction techniques and materials used are same; except the later model is much more improved.
- RCC main pillars with reinforced base, additional wooden pillars, bamboo mat walls, wood frames, C I sheet roof, and metal wires and pegs are used.
- These are constructed and quality control supervised by Brac too.



Homestead plinth heightening is done in the later reconstructions.



Brick boundary around mud plinth is added later.



No cross bracing used, wooden frame with vertical and horizontal members used.



Users can make additional structures adjoining the house according to need.

**10: Brac relief house (*dochala* type)**

### 3.2.3 RELIEF HOUSES BY ISLAMIC DEVELOPMENT BANK

- These houses are distributed by Islamic Bank Bangladesh Limited; the donor is Islamic Development Bank (IDB).
- This has a model provided by consultants.
- The house has a *dochala* roof with an addition *ekchala* extension. These two roofs are separate from one another.
- The full structure has walled enclosures from all sides and resembles a box.
- Only the front side of the house has one door and two windows. The other three sides are closed walls of C I sheet.
- The eave of the roof at the front is extended. The plinth is high compared to the other houses.

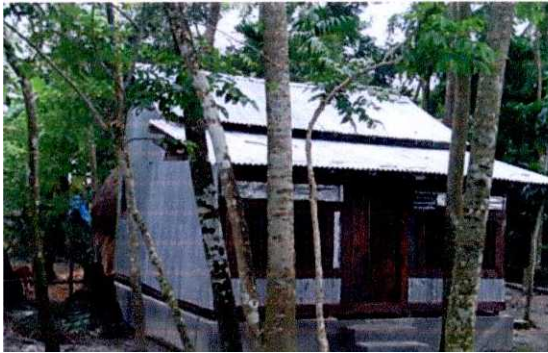

The house has a main room with an extended portion, but no verandah.

Wood frame is used with C I sheet walls and roof. Wood is used extensively.

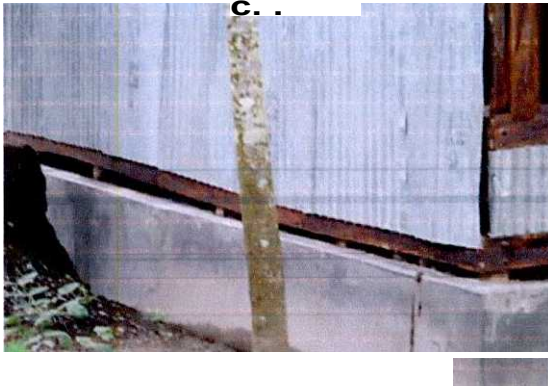

N . .

All wooden posts are of same thickness and not embedded into the plinth. Only the four main posts are embedded inside the plinth.



Mud plinth is used with brick and plastered boundary around it and plastered steps at the front.

11: IDB relief house



### 3.2.4 RELIEF HOUSES BY DANCHURCHAID

- These houses are distributed by DanChurchAid through a local NGO named Dustho Shasthya Kendra (DSK).
- Twenty thousand taka, eighteen bundles of C I sheets and some cash are provided as relief package for each house construction.
- It was observed from the field visit, that the recipients of these houses do not own any land. The houses are constructed on *khasjami* near the river bank.
- There is no set house model to follow. The recipients have the freedom to choose size, form, materials etc. according to their need and ability.



The recipients constructed the houses themselves.



Wood, bamboo, betel nut trunk etc are used in frame according to ability, iron pegs are used in joints.

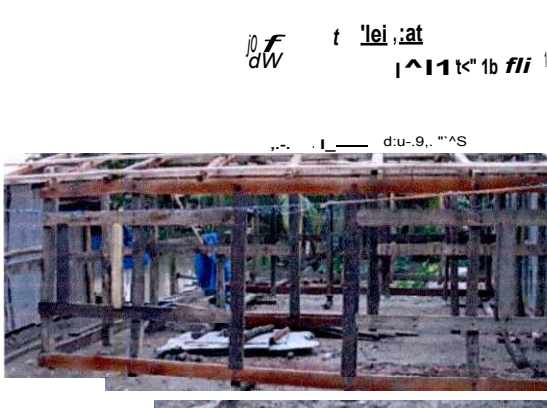

Frames rest directly on the ground, does not have cross bracings.



Many materials are reused, for example the decorated wooden wall here.

12: House constructions by DanChurchAid grants

## AN OVERALL CRITICISM OF THE RELIEF HOUSES:

Some of the positive points of these houses are:

- The recipients of these houses are females. So from social aspect it can be said **that they would not have to suffer displacement if the male members die or are lost in the sea.** This will play a vital role to counter effect the fact that **especially women, children and older persons will be more vulnerable as climate refugees.**
- The Brac house with *chouchala* roof is much appreciated by the users from space quality as it has a verandah at the front.
- The cross bracing with wooden frames on the walls of Brac house is taken very positively by the craftsmen. They decided to use this idea in future **constructions as these do not cost much but make structures stronger.**

The drawbacks **observed are:**

- It was found that those houses that are constructed and/or supervised by the providers have better qualities. But the house constructions undertaken by **local contractors have poor quality, though the design and materials are good.** So quality control plays a significant role here.
- **All the house models are more or less of same measurements . This has been done to maintain a standard . But the individual requirements of users are ignored . The users are not allowed to implement any ideas here.**
- It has been observed in the houses constructed by DanChurchAid grants that **as there are not a set model and users have freedom to make houses on their own according to needs; the constructions are often too ambitious. As there are no guidelines, the constructions may not be possible to finish in the fixed budget. So the good intention to let people decide and build on their own has been lost there.**

- Relief houses are given to those only who have own land. But DanChurchAid grant is given to those who even do not own land; these people are making houses on *khasjami*. So the fear of eviction remains here.
- It was observed in the field visit that as houses are given as relief packages, the natural tendency of people to rebuild was lost in the locality. This will put a negative effect in the social environment in the long run.
- It can be said from the past records, that disasters make ways for better solution and bring out the present drawbacks. But the relief houses distributed in Sarankhola lacks that quality. The designs and implementations of these are done from outside. There is no scope of participation of the users.

## B. LITERATURE REVIEW

### ***3.3 HOUSE AT SUBARNA CHAR IN NOAKHALI***

This investigation was carried out by IUCN at Subarnachar upazilla in Noakhali district with an objective to make the traditional houses structurally stronger against high wind, a common hazard there. Different local homestead arrangements were studied; and an integration of the traditional building techniques with "Building for Safety" approach has been explored.

#### **Characters:**

Some characteristics of typical homesteads/ houses in the region that were found from the study were:

- Homesteads face east.
- These have ponds usually at the south, created by earth cutting for raising the plinth. Fruit bearing and timber trees surround the homesteads.
- Natural indigenous materials like bamboo mat, straw, sun grass and wood are mostly used. Tying material is nylon rope. Few houses have C I sheet walls and roof with simple wooden truss.
- Roofs are *chouchala* and *dochala* type; tied with extra posts and ropes with trees to protect against wind.
- Wooden posts are not embedded into the ground, but rest on concrete blocks for protection against insect and dampness.

#### **Process:**

The total process of house building was carried out in a participatory approach. Focus group drawing and discussion, interviews, both way trainings, trial and errors etc were followed in the methodology. The local craftsmen and dwellers with the external consultants were involved in analyzing local hazards on houses, choosing different options in design, **material**, budget, and later in the construction. The whole process made it more logical for future application of the gathered knowledge for all the groups involved. Later the findings were disseminated through publications to put the knowledge in practice.

It was tested that improvement of houses can be met with local skills and resources. The building cost of a "Building for safety" type house is not more than sixty

thousand taka, which does not exceed that of a traditional house. Moreover, materials in good condition can be recycled from the old structure. The cost of strengthening a house is not more than twelve thousand taka.



Consultations with all the groups helped to bring out the best options



Ramming of earth for preparation of homestead

13: Processes carried in the house construction at Subarnachar (source: IUCN, 2007)

### **Interventions:**

The step by step actions needed for the construction of "Building for Safety" house were suggested and practically implemented in the process. These were as follows:

Homestead preparation-

Appropriate homestead site planning is needed as the first step of construction taking care of the qualities of site concerning drainage facility, flood level height consideration, easy accessibility, sun and air. Sites with arsenic contamination, garbage disposal etc. is advised to avoid.

- The site needs to be prepared by leveling, dressing, turfing and compacting. Compaction of the earth is very important for the durability of the site. Flood proofing of the land has to be done by drainage channels connected with water bodies, making proper slopes from the center to the sides etc.
- Plantations have to be done for protection against flood, erosion and strong wind, to enhance income, ensure privacy and define territory.

## House construction-

Plinth stabilizing has to be done by compaction of the mud for construction. This can be done better by adding 5% of dry cement by volume with dry mud, mixing it well with water and using the mixture as capping on the upper six inch of plinth. Proper construction methods have to be followed with selection of soil, mixing of materials, curing etc. Plinth height recommended is 18".

- Cross bracings in wall and roof frames are strongly recommended; and improvements of these have been demonstrated. Measurements of the members and spacing between these are suggested. Battens in cross bracings should be laid at the inner portion of the house, tied with nails with washer and nylon ropes, and treated with local oil to guard against weather effects.

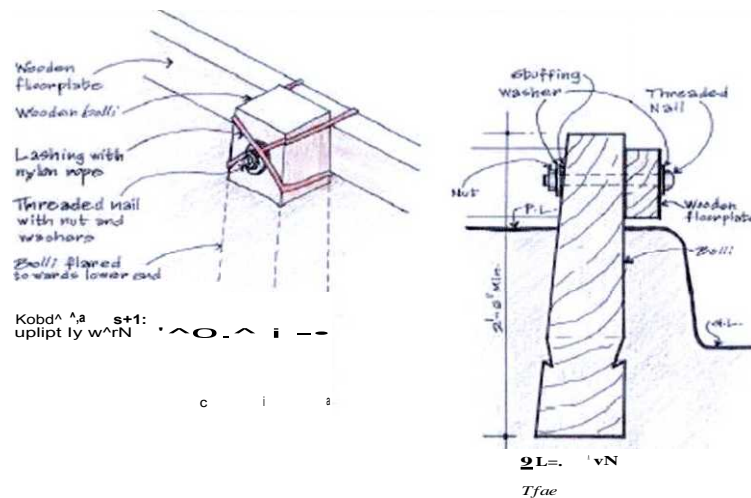

Improvement of *bolli* anchoring with base (source: IUCN, 2007)

### 1: Technical detail of foundation

- Improvement of typical *bolli* anchoring is suggested. This should be done by providing a notch at the lower end for better anchoring, fixing the *bolli* to the floor plate with screw nail, washer and bolt, and tied with nylon rope.
- Minimum roof slope should be 25°; hipped (chouchala) roof is better in wind resistance and less rain penetration. Twisted roofing nails or J- hooks should be used for tying C I sheets. Rafters and purlins spacing are recommended; suggestions have been given for roof frame.

#### CRITICISM:

The study has closely explored the practices in house constructions followed in the region. The suggestions have come out from these, so adoption from these suggestions would be possible and practical for the inhabitants. Any typical model house has not been suggested. The users can implement what is appropriate for them. Moreover the construction cost does not exceed than that of a typical traditional house and some materials can be reused too. It had been found that the whole process has been taken very positively by the inhabitants.

But the statistical analysis of resilience of these houses has not been available yet compared to the traditional houses considering wind hazard, as there has not been strong wind hazard after the constructions. Nevertheless it can be presumed that these houses will survive better.

### 3.4 DESIGN AND CONSTRUCTION GUIDELINES BY ADPC

The handbook by Asian Disaster Preparedness Center (ADPC) provides some design and construction options for different types of houses against flood damage in the rural Bangladesh. The objective of the handbook is to disseminate techniques in house construction in simplified and illustrated manners that can be adapted by villagers easily to reduce flood risk in house damage. The solutions are targeted for the low income population taking care of the house types, materials and methods commonly used. Guidelines are provided in cost effective constructions without compromising quality. Some of these guidelines can be followed in hazard resistant houses in the coastal areas as these give ideas of protection against torrential rain, water logging, wind storm etc.

Some of the guidelines that can be followed for the coastal region considering the different elements of a house are:

#### Plinth:

- Mud plinth can be made stronger with cement stabilization. The quality of soil can be tested, and sand and cement mixed accordingly.
- Brick perimeter walled plinth prevents erosion of the plinth mud from sides. Brick and concrete plinth is more expensive but durable.

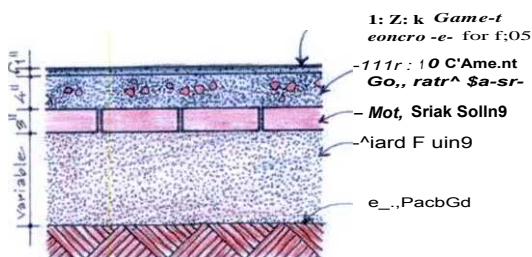

Details of plinth of cement concrete



Mud stabilization of plinth

**2: Techniques of making plinth stronger against erosion** (source: ADPC, 2005)



Post:

- Concrete stump (*kaatla*) on the base of bamboo/ timber connecting it with mild steel clamps can be used. This reduces the recurrent cost for replacing as bamboo can last for five years in this treatment. This increases the stability of the structure.
- RCC posts with spread footing can be used for water and wind resistance, and durability.

				.tr-dF4 V*J {a- attft n1 to ro4v* o plptvi
q^	<b>bash vim:</b>		T:m6e-Op b^nb00 pa9t.wJ^	^ ^
^	^..wbal alpr+p, -00		8 ^ red4.1	<: u. J v..:
i .wAf	^k<Yv/11 6 G ^,		g f y,n	*g1' f .01 rods v4n^
		{ c		5^u ov
	G^3..r xy	a 4	^ ^.	ikaGI r ^i EL c ^ h
	4'x 4^K 2 c'	S		y
	{v}vll^y .l^Jo v.jr.- rr>C-ft:			
^<	Y-OF F(vr /bij-Spr .rr		e^Ired:l.ra ^o^ info plinth,, r^ ^wdsrov^,d i •^T	. V!
	ai			
Concrete stump ( <i>kaatla</i> ) for protection against dampness	Reinforced concrete post used			ca be used as main pillars

3: Techniques of making posts stronger (source: ADPC, 2005)

Wall:

- The lower end of wall with temporary cheap material like straw, jute stick can be replaced later. The lower end can be painted with bitumen for protection.
- The lower end of wall and can be protected against dampness with C I sheet covering (*gorani*). The end of gable roof can be protected like this with C I

sheet triangular covering (*bhelki*). This is a local construction method in some places.

- Cross bracing with split bamboo sections in frames increases stability against wind load and helps the structure to remain stable in base.

**Roof:**

- Aerodynamic roof form prevents the effects of uplift and suction. Roof pitch of 30°- 40° and hipped shape is better. Ends need to be tied with structure. RCC roof is the best against wind load.
- Rafters, cross bracings and other strong connections between roof and vertical structure are needed. Metal straps and bolts with washer are better than simple **nails.**
- C I sheet needs to be nailed in every corrugation. J hooks and twisted roofing **nails are better.**
- Roofing elements need to be connected properly.
- Rainwater gutter prevents splashing of rain and damage of wall, and helps in harvesting rain for drinking purpose.

Hollow concrete stump for posts, hollow cylindrical RC post, metal post and roof frame, Ferro cement, stilt etc have been suggested as some innovative materials and ideas.

Design considerations for homestead planning have been suggested. For example, increasing homestead height to stay flood free, providing natural drainage, making safe access, land selection and preparation etc. basic services like water supply, sanitation, energy etc have been suggested. Sustainability of the settlements with employment opportunity, financial supports etc have been suggested. Landscaping, cultivation of natural building resources have been encouraged.

## CRITICISM

Though the **handbook has been targeted for the rural population** with flood risk, **many solutions match with the problems faced in the coastal areas. Most of the materials are common. The targeted income group can be thought as same. The options can be implemented there with modifying approaches where necessary.**

Salinity as a hazard needs to be checked in the construction approaches; chemical treatment for it may be necessary. Metal constructions need extra precautions where exposed.

### ***3.5 DESIGN PARAMETERS BY HOUSING CLUSTERS AFTER CYCLONE NARGIS***

Cyclone Nargis was a weak category 4 cyclone. It had landfall over the mouths of the Irrawaddy river in Myanmar coast on 2nd May 2008, with reported 146,000 deaths. It is considered as one of **the deadliest** cyclones in the North Indian Ocean **Basin in terms** of human casualty (Wikipedia). The cyclone **caused** flooding for several days by heavy **rain and** storm surge in the low lying areas that added more to human misery.

The Post Nargis Joint Assessment Report (PONJA) estimated that the storm destroyed or damaged about 450,000 houses; and made full or partial roof damage to 350,000. The Technical Working Group (TWIG) of Shelter Cluster reported about three fourths of the houses were rebuilt by the owners from salvages materials with harvested bamboo and thatch as structural and non- structural materials. But the quality is poor and partial or total replacement is needed between one to two years time.

The Myanmar Emergency Shelter and PONJA developed guidelines for housing reconstruction in the affected areas. It was understood that the humanitarian agencies have limited capacities and resources, and the number of shelters built by them would be limited. But TWIG and the government need to have a set of parameters for the early recovery phase with mutually agreed conclusions that can be met in short time. The Ministry of Construction plans to make about 100,000 houses of 20 x 16 square feet in size, with timber frame and cladding, and GCI sheet roof. The cost of each unit is USD 600, with 90% government discount on timber.

The objective guideline is to support the communities affected by the cyclone in re-establishing their traditional ways of sheltering with improved safety. This will be implemented with strategies to reduce vulnerabilities in the most effective and equitable manner considering the scale of need, limited resources and limited access to the affected region. Some of the guideline principles are that the program will take account different needs of communities and response with appropriate assistance; it will maximize the positive impact on the local economy; disaster risk reduction plans will coordinate with other clusters and government ministries etc.

Some of the design **parameters are as follows:**

Internal plinth area	160 square feet, expandable to 320 square feet.
Wall eave height	Minimum 7 feet.
Roof slope	300
Roof design	Allow rain water harvesting.
Roof projection	1'-6" for main building, canopy should be separated from main building.
Roof material	Water tight, durable, locally available, low-cost, easy maintenance. GCI-sheet can be used in urban or suburban area.
Wall material	Water tight, durable, locally available, low cost, easy maintenance.
Minimum life span	Minimum 4 years, the more durable the better.
Resistance to wind	Withstand 80 mph wind speed.
Resistance to earthquake	Withstand 6.5 Richter scale or Seismic Factor 0.15, detail joint solutions required.
Resistance to flood	Minimum plinth level 1 meter above normal highest tide level.
Privacy	Minimum one private room in the house.
Step to plinth level	2 egress, each one in the front and back of the house.
Door and windows	Minimum 2 doors and 2 windows, allow cross ventilation and access from the front and back of the house.
Water and sanitation	Allow rain water harvesting and latrine within 5 meters radius from the house.
Core house expandability	Flexible enough for future expansion.
Minimum cost	Minimum USD 2 / square foot.

**1: Design parameters for housing cluster (source: Shelter Cluster, Myanmar Nargis)**

- The internal plinth area is calculated in sphere standard that is 3.5 square meters per person. The minimum plinth area is considered as 140 square meters or 160 square feet, assuming an average household of four persons. If a household size is larger, the international NGOs can provide larger units.
- Rafters should be tied to walls/ columns with proper joints.

- Provision of ceiling should be under the roof.
- As the houses in the delta region are on stilts, locally available durable flooring materials are needed (example, split bamboo).

**Some of the humanitarian parameters are:**

- **Both minimum and maximum parameters will be set.**
- **Housing activities will not exceed common local standard.**
- **Agencies will respect local indigenous building knowledge and seek to support it, and not assume that the introduced knowledge is superior.**
- **Activities will attempt to strengthen the environment but not diminish it.**

Specifications of MES design (9x 18 sq ft) are:

Type	Main Frame	Wall	Floor	Roof	Total Cost
1	Timbers	Timbers	Timbers	C.G.I.	7.2 \$/sq ft
2	Timbers	Timbers	Bamboo	C.G.I.	5.7 \$/sq ft
3	Timbers	Bamboo	Bamboo	C.G.I.	4.5 \$/sq ft
4	Timbers	Bamboo	Bamboo	Thatch	3.8 \$/sq ft

**2: Specifications of MES design**

House design by **Myanmar Engineering Society (MES)**:

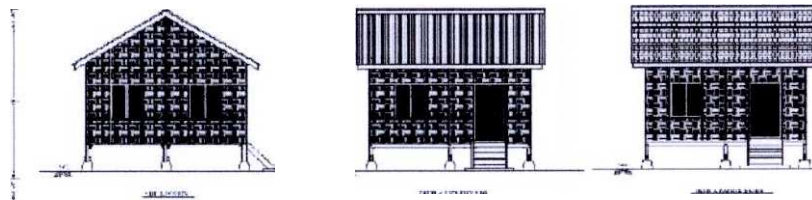

**4: House design by Myanmar Engineering Society (MES)**

**House design** by UN-Habitat:

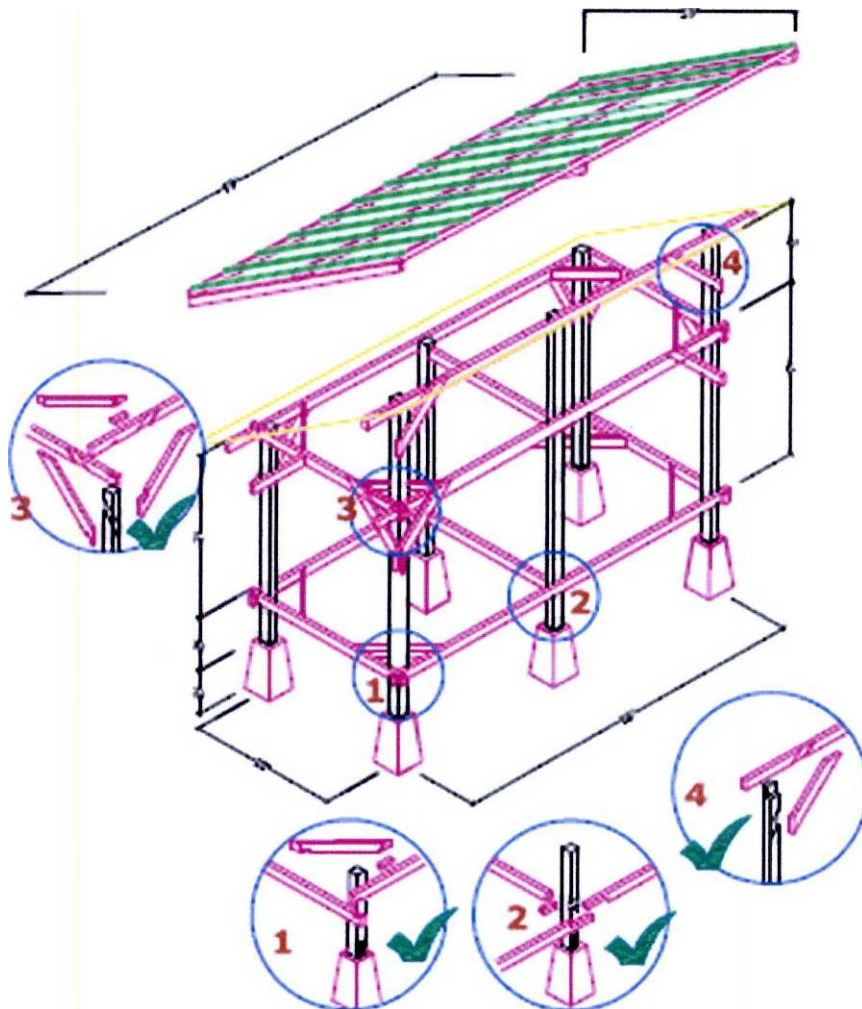

**5: House design** by UN-Habitat

**UN-Habitat Design:**

Life span: **over 10 years**

**Plinth area: 10' x 16' = 160 sq ft**

**Foundation: concrete footing**

**Main Frame: timber**

**Roofing purlins, flooring, wall cladding: bamboo**

**Roofing: thatch**

Cost: USD 2.25 / sq ft

House design by REAM (a Myanmar NGO):

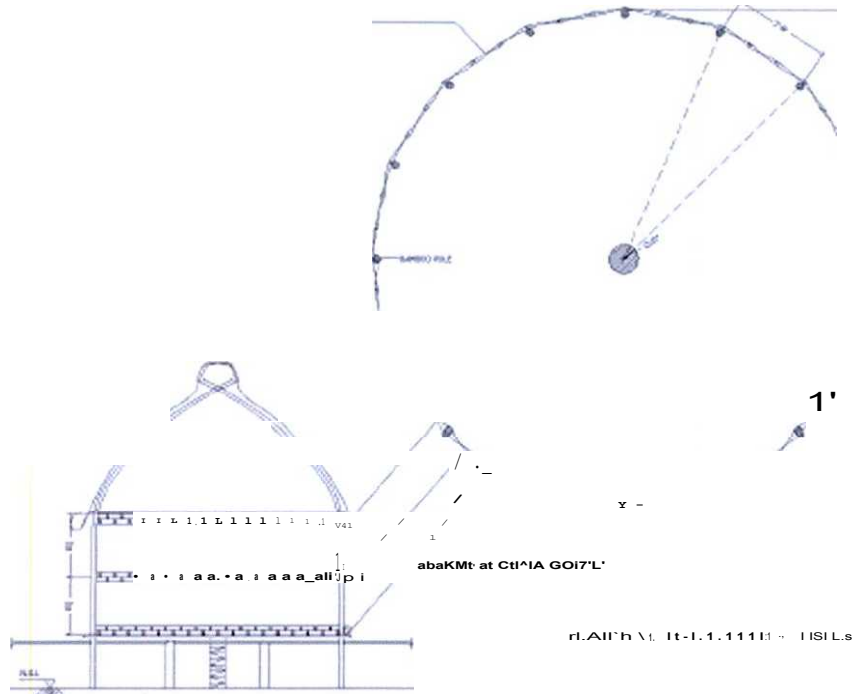

REAM-Design:

Life span: 2 years

Plinth area: 156 square feet

Cost: USD 2 / square feet

Structure, wall cladding and flooring:

coconut trunk and bamboo

Roofing: tarpaulins

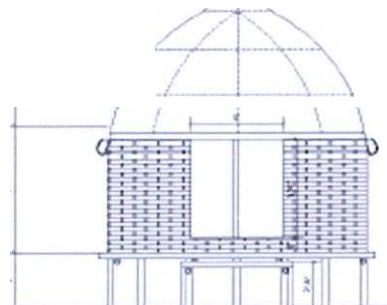
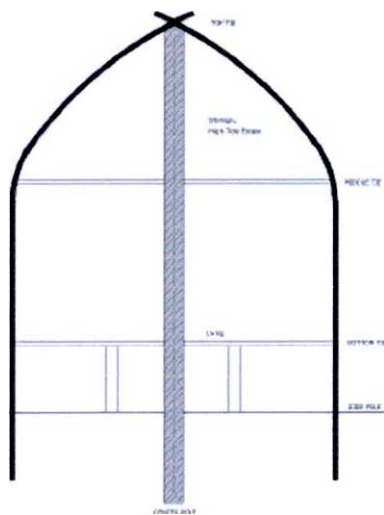

6: House design by REAM



**CRITICISM:**

**The space calculation considering household size and future provision of the dwellers to expand it is a positive approach. Use of indigenous materials and knowledge will help to enhance the quality of built space that people use. Use of local materials will help to construct targeted number in due time and help in the reconstructions later.**

Reconstructions and the chance to improve the quality of built environment will get restricted from the parameter that housing practice will not exceed the local standard. From this point it will not be possible to introduce better material or design in a locality that lacks in these qualities.

**3.6 COMMUNITY BASED DISASTER SHELTERS IN ORISSA, INDIA**

This study describes the approach taken by Swiss Agency for Development and Cooperation (SDC) in the coastal villages of Orissa after the devastating cyclone of October 29th 1999. About 10,000 people and 3 million cattle perished, and 750,000 houses were destroyed in the cyclone.

Thirty two multi purpose schools cum cyclone shelters are integrated in this program. Different design options are provided for these disaster shelters; stilted design is provided for highly flood prone areas, and shelter with raised platform for areas with low level flood. Community Based Disaster Preparedness (CBDP) program is first integrated with these shelters by SDC, which is a pioneering concept in the villages in that time.



Design of shelter with stilts



Design of shelter with raised platform

**14: Disaster shelters by SDC**

Different low tech low maintenance innovative ideas integrated in the design are:

- Glass blocks used in walls as daylight inlets.
- Rounded skirting on floor and roof ensure better drainage.
- Rooftop tanks made for rain water harvesting.
- Emergency toilets with holes in the floor are provided in the stilted designed shelters.
- Shelter design has scope and space for future expansion.
- Design has the scope of providing additional uses specific to village needs.
- These have water supply and electricity connections.
- There is garden developing space around the building.
- It gives people the opportunity to meet and develop new ways of income generation during the normal time use.

#### CRITICISM:

- The integration of community based disaster preparedness through this shelter will enhance its role and viability more in the community. It will lessen the number of **casualties and injuries**.
- Low tech innovations are worth to follow and maintain by other such projects.
- The future physical and functional expansion scope will make it more compatible.
- Option for different designs is a good approach.
- The shelter as income generating hub will enhance the poverty alleviation activities.
- People will be in better condition in restarting their lives after disaster through shelters like these.

### 3.7 CYCLONE SHELTER BY BRAC

After the cyclone SIDR of 2007, it was observed that cyclone shelters had a great role in keeping the number of deaths low. But there are many places in the coastal areas that do not have any shelters. An initiative was taken by Brac after this, to construct one hundred shelters in the vulnerable areas of the coastal belt that still do not have shelters. These shelters are under construction, as fund was allocated in the reconstruction phase after the SIDR cyclone.

Some design considerations of these are as follows:

- Lands are purchased by Brac for the cyclone shelters. Designs and constructions are done by Brac as well.
- Lands are selected that do not need land fill, have easy approach road, and are near the settlements. The locations are flood free and erosion free lands.
- Seven types of designs are proposed with one or two levels of vertical expansion, and with/ without *killas*.
- Another piece of land is bought beside the shelter for *killa* construction in some places.
- Land areas that are dug up for the earth fill to build the *killa* are used as community ponds.
- Capacities of these different types of shelters are from 1,000 to 3,600.
- Construction cost of these each are between nine million to eighteen million taka.
- Gender segregations are considered in the designs. Separate toilets are provided, separate rooms can be used while in function too.
- Two large overhead water tanks are designed to be used with pumps and generators. These can be filled during the evacuation time when danger signals are hoisted. There is no provision of rain water collection.
- Natural ventilation is provided in the designs.
- Doors and windows are of thick metal sheets.
- Alternate uses are selected as school, health center (like *Shobuj Chhata*), Brac office etc.

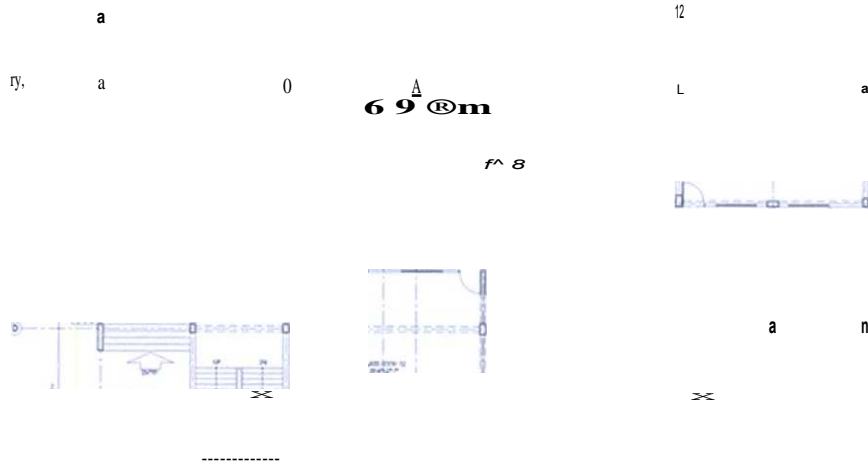

GROUND FLOOR PLAN

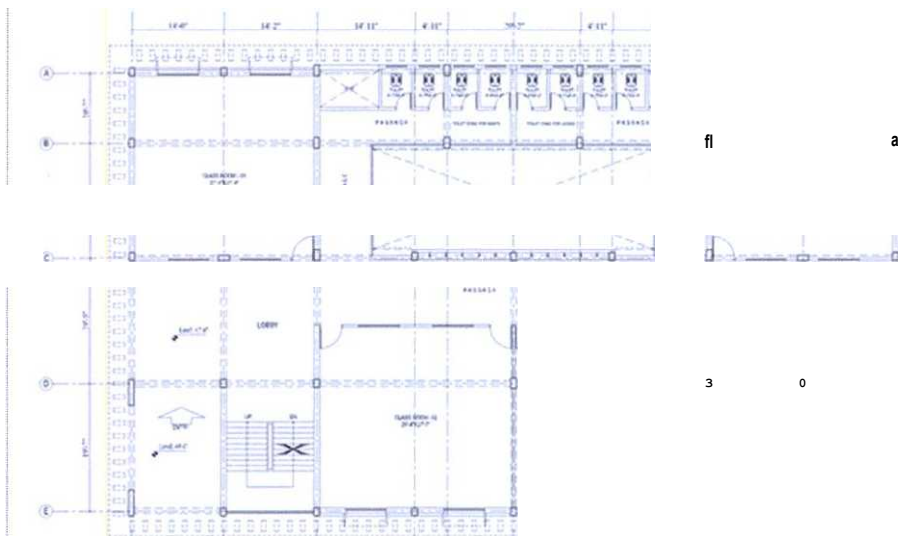

1ST FLOOR PLAN

7: Plans of cyclone shelter by Brac (source : Architecture Department, Brac University)

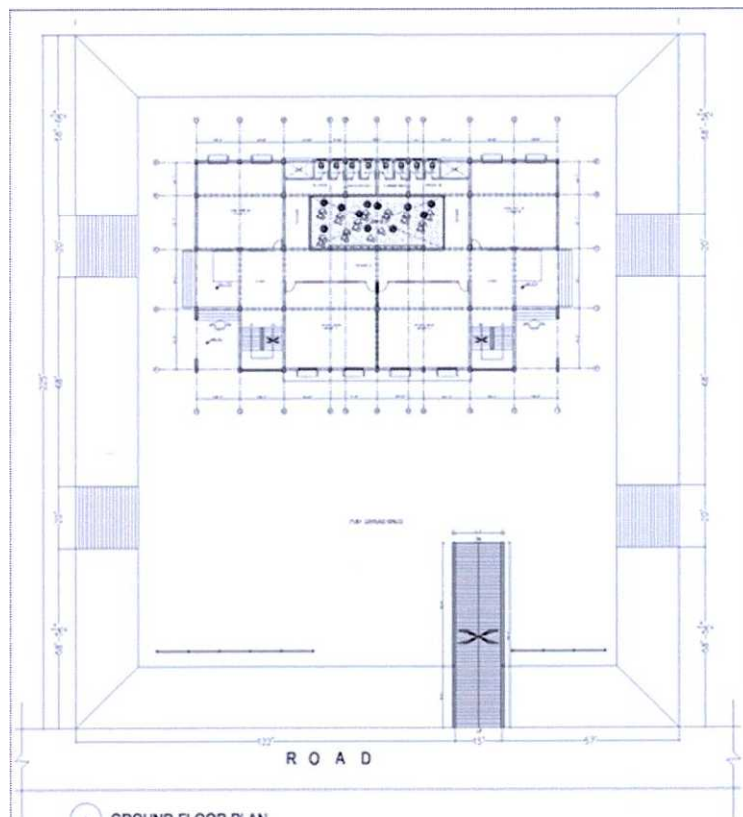

1 GROUND FLOOR PLAN  
 DESIGN OF PROPOSED CYCLONE SHELTER FOR BRAC

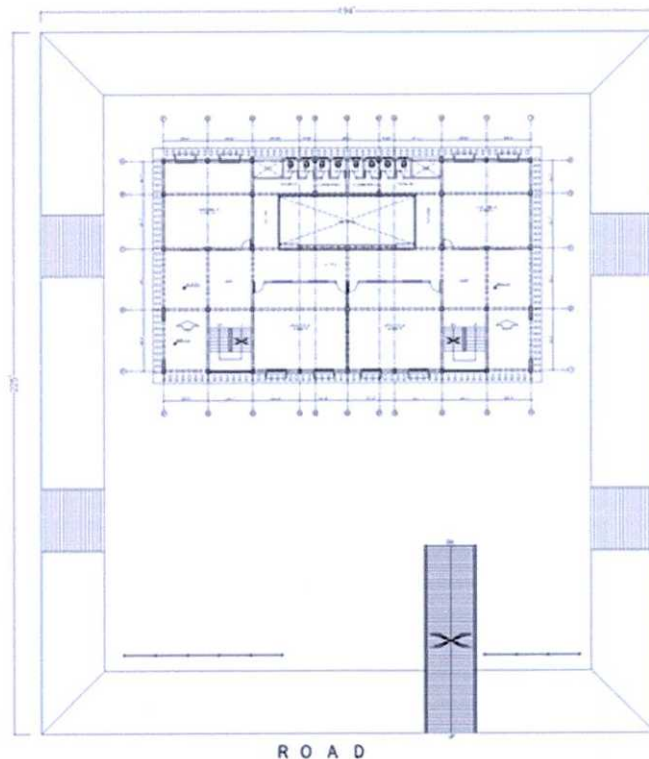

2 1ST FLOOR PLAN

8: Plans of Cyclone Shelter by Brac (source: Architecture Department, Brac University)



**9: Elevations of Cyclone Shelter by Brac (source: Architecture Department, Brac University)**

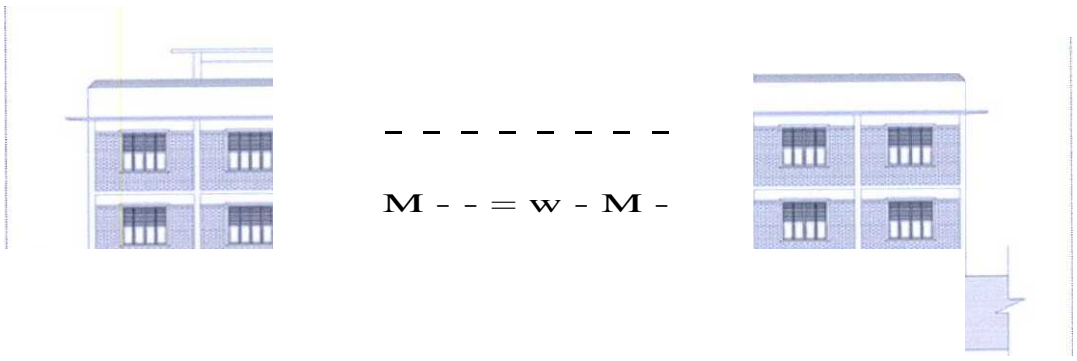

SOUTH ELEVATION

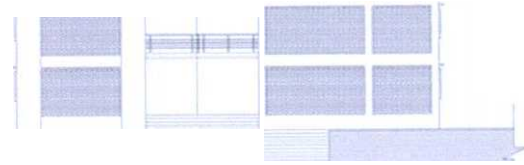

WEST ELEVATION

**E7**  
**L**

||| ing's

EAST ELEVATION

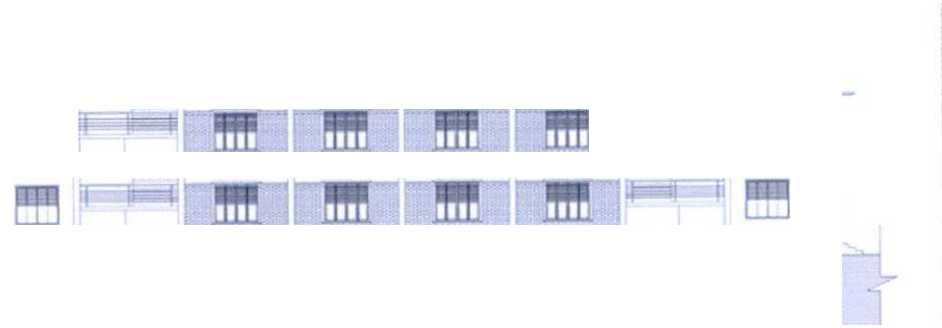

NORTH ELEVATION

10: Elevations of cyclone Shelter by Brac (source: Architecture Department, Brac University)

**CRITICISM:**

**The shelters are built near the settlements in the areas that do not have any cyclone shelters in the vicinity . These have definite alternate use for the normal time and will be maintained by a definite authority . The alternate uses are community oriented that will attract people . It can be assumed that these will serve the community well in both the normal and crisis time.**



## 4. STRUCTURAL STRENGTHENING OF SETTLEMENTS

### *4.1 RURAL SETTLEMENT PATTERNS AND CHARACTER*

The different physiographic regions with their varied characteristics have shaped the settlement patterns of the country. Different physical, cultural and local conditions play a significant role in shaping distinctive forms and patterns of settlements. The settlement patterns throughout the country can be broadly grouped into the followings:

1. Nucleated settlements in the high flat land,
2. Settlements scattered and built on artificially raised land,
3. Linear settlements along the river levees,
4. Scattered and isolated settlements on offshore islands,
5. Highly dense clusters on artificially built mounds, and
6. Separately built homesteads in hilly areas.

(Hasan, D. M, 1985)

The settlement pattern in the study area resembles with the scattered and isolated settlement pattern of deltaic and offshore islands. These areas are more subjected to natural hazards for remoteness, harsh exposure to nature, lack of communication facilities etc. The inhabitants of this region adapt to a distinctive lifestyle and living environment to cope with the situation.

The character of this kind of settlement is that after an island is formed a few years are let to pass before the ground become suitable for agriculture. Then few families arrive on the island. They dig a pond on the island as source of fresh water for domestic consumption and build homesteads dispersedly around the pond with the excavated earth from it. In course of time, more families arrive and build houses in similar way around the pond near the acquired agricultural lands. Gradually dispersed homesteads grow along the island with a pattern of its own that turns into small isolated settlements around the water source.

The traditional rural house form is evolved through some determinants like available land and its character, culture, socio economic status of the dweller, effects of

religion, climate and available resources. Usually these are built of indigenous and locally available materials with local construction methods and techniques. The low income people build their houses mostly with natural materials from their immediate surroundings; materials are taken from here and returned to decompose again; in terms of affordability and availability these are optimum and sustainable (Kabir, K.H, and Mallick, F. H, 2005).

The general character of the rural homestead is introvert layout with spaces created for domestic use. Usually this is provided by a common court yard at the middle or creating space around the homestead by planting trees and making pocket spaces. This makes a secluded area for the women folks from the passers by, where chores can be done conveniently with a sense of privacy.

The rural house forms have evolved through a long time and it has not been influences from industrializations (Seraj, S. M. and Ahmed, K. 1., 2004). The traditional rural homesteads are gradually changing its form and character for the change in family structure and smaller nuclear size; and concision of larger spaces are occurring for cost and maintenance. Changes in different livelihood, livelihood practice, scarcity of available resources and energy sources, cost and availability of land, better communications with the towns, exposures with luxury amenities etc are changing the quality of life and thus the homestead spaces. The use and purpose of different domestic spaces and their associated values are changing with it. Nevertheless the distinct quality of homesteads is still prominent in the rural Bangladesh.

## ***4.2 CONCEPTUAL FRAMEWORK***

The planning and development of the coastal areas need to be context specific according to the hazards, topography, environmental quality, target group, available infrastructural facilities, socio economic settings etc. The region has multiple hazards. Some are regular like erosion and salinity, some are seasonal like wind storms, and some yet dormant like tsunami and earthquake. Cyclones can be taken as one of the severe among these for its frequent visits and catastrophic damages in the past. The target group here are mostly poor and ultra poor; infrastructures are inadequate and of poor quality.

The materials chosen for the designs of the different elements should be considered on availability, affordability, construction, maintenance etc according to the target group and environment. Salinity causes corrosion on RCC structures, and salt formation on brick structures in this environment. The natural indigenous materials used in house construction by the inhabitants are often damaged from the natural consequences like heavy rain, dampness, infestation etc. So sustainability of the use and maintenance of materials is an important issue. Safety against materials during disaster should also be considered. For example, C I sheet is extensively used as wall and roof material for its durability, reusable quality etc. But it becomes a deadly weapon when blown away during strong wind. Implementing different techniques in constructions may be a feasible solution in using these materials for their adoption, availability and affordability.

Settlement pattern, grouping of communities for better function of available infrastructures, inventory of safe havens, connection between different units within the community and the outer world with roads, phone network etc, and reducing commuting time with the nearest help center for relief, medical help, news dissemination etc should be considered in planning aspect. For this purpose catchment area, walking distance etc may need to be rethought and redefined for smaller communities considering different age group, gender division etc.

Strengthening of the existing houses and providing solutions for new constructions should be considered. This will reduce the extensive rebuilding activities after every major disaster, and help maintain the quality of the built environment. At present a lot

of house constructions from the help of different organizations have been going on in the SIDR affected regions, as has been observed in the study area. Though there is little scope for implementation of local knowledge or personal needs in these houses, the inhabitants and the local craftsmen can judge the compatibility of these in the local context concerning affordability, availability, durability etc. The lessons learnt from these would help them to improve houses in the future. Consultations with the house builders of the outside world will also encourage them in innovations as the both groups now have the chance to communicate more.

Community based smaller cyclone shelters that have definite function during the normal time may be a good option in the settlement planning. The cyclone shelters can be decentralized and brought near the settlements in this way. It has been also suggested by the inhabitants of the study area as a means to protect themselves and property. Rescue and rehabilitation programs can be operated from these shelters after disasters. A suggestion can be that the NGO offices working in the locality can be used as community based cyclone shelters or safe havens during disaster.

The existing schools, madrasa, mosques and other community based organizations should also be improved so these can act as safe havens during disasters. These can serve better as shelters during disasters as these are more dispersed inside the settlements and people can relate themselves better with these institutes.

The structural strengthening of settlements in the vulnerable coastal areas will be explored in the research taking the study area as a typical test area. Instead of going for ambitious thoughts, the available resources and possible helps will be explored.

### ***4.3 VULNERABILITIES AND CONSTRAINS IN PLANNING***

The severe cyclones originating in the Bay of Bengal have very large diameter and wind speed and these can travel inside the country quite far. Cyclones generally cause damage in three ways- very strong wind, heavy rainfall and storm surge. These are most frequently experienced in the low lying coastal areas like Bangladesh. Wind speed in a strong cyclone can be more than 200 km/h. Heavy rainfall can exceed 800mm in a single day. Such intense rainfall can lead to flooding and water logging which can cause considerable loss of life and damage of property in days following after a cyclone.

For the construction of physical infrastructures sufficient drainage system, protection against storm surge and protection against high speed wind is required. If possible the natural drainage system should not be disturbed to let rain water pass, and should be more enhanced taking care that surge water can also pass through it but not harm the environment with salinity. Single storied structure with closed ground floor plan is deadly for storm surge; it gives a false sense of security and does not allow people to escape if tide enters inside the structure. So structures with open ground floor plan will be better here. Wind barriers need to be provided for high structures, plantations can play a vital role here.

But considering earthquake open ground floor plan will lead to soft storey failure. Tilting or settlement of structures may also occur for the liquefaction effect. Very large elongated structures may not be feasible for earthquake (NICEE, 2004) and tsunami effects, and salinity will increase the maintenance cost of large RCC or brick structures.

**As tsunami warning gives very little time for safety measures , protection of grains within this short time needs to be taken as well as livestock and other possible assets. It should also be measured if the earthen embankments can withstand the tidal waves in a tsunami.**

As erosion is a common hazard, private lands containing homesteads, cropland etc should be given priorities to be protected; these need appropriate landscaping. Land acquisition for homestead purpose should be given importance, as landlessness will increase vulnerability to disasters.

## **4.4 LAND USE AND PLANNING**

### **4.4.1. LAND USE PRACTICE**

The land use pattern of the area has to be analyzed. The habitations, croplands, areas with potential resources, future extension of different land needs have to be identified. Assessment of how much protection can be provided for these during disasters needs to be explored by dividing the total scenario in different return periods; for example fifty years, one hundred years etc with the changed land use practice. The level of risks and threshold of resilience from different future disasters need to be calculated.

The hazardous areas need to be avoided in case of more vulnerable practices like settlements, schools, hospital locations etc. Relocating of infrastructures or hazard proofing of the locality may need to be applied with proper compensation and taking care that these practices are not repeated. For example, shifting of settlements, locations of schools in safe zones, making roads durable and above flood level etc can be thought. Considering this, some areas may need to be developed in concentrated compact township **manner**, and some evacuation points may need to be dispersed inside the community considering the contexts of the locality. These can be checked during the recovery phase of a disaster in the time of reconstruction. But it has to be taken care that livelihoods are not compromised by relocations.

The natural drainage system of a place should be maintained as much as possible. There may be future hazards like congestion from heavy downpour, future floods from upstream or unusual tide. Land use practice should protect the area and make it sustainable for humans.

Considerations for the planning may be:

- Relocation of the Union Parishad Bhaban may be needed in the study area as it lies outside the embankment. This is a risk zone; the position of this important structure along with utilities will attract more growth that will give a false sense of security.
- The new location of the Union Parishad Bhaban can act as a base for river route for receiving reliefs after disaster as this will have necessary infrastructures.

- **Some areas** of the locality **with basic amenities** may be **selected as evacuation points that can act as nodal points in the community** . These can be developed **in compact township manner** with vertical **expansions** . **Reliefs in the aftermath** of disasters **and developments in the normal time can be generated from here** .
- Some safe havens **like mosques, schools, NGO offices etc can be** dispersed **inside the settlements** that will make **evacuation easier in the event of disasters** .
- **Some new roads** can be proposed for settlements **to reduce distance** .
- Future **expansions** of settlements **can be along roads and near the** safe refuges **taking care that water logging is not created in this practice** .
- **Places outside embankment can be used** for plantation exclusively.

	<p style="text-align: center;">I s p a</p>	<p style="text-align: center;">el 3-5 6</p>
--	--	---

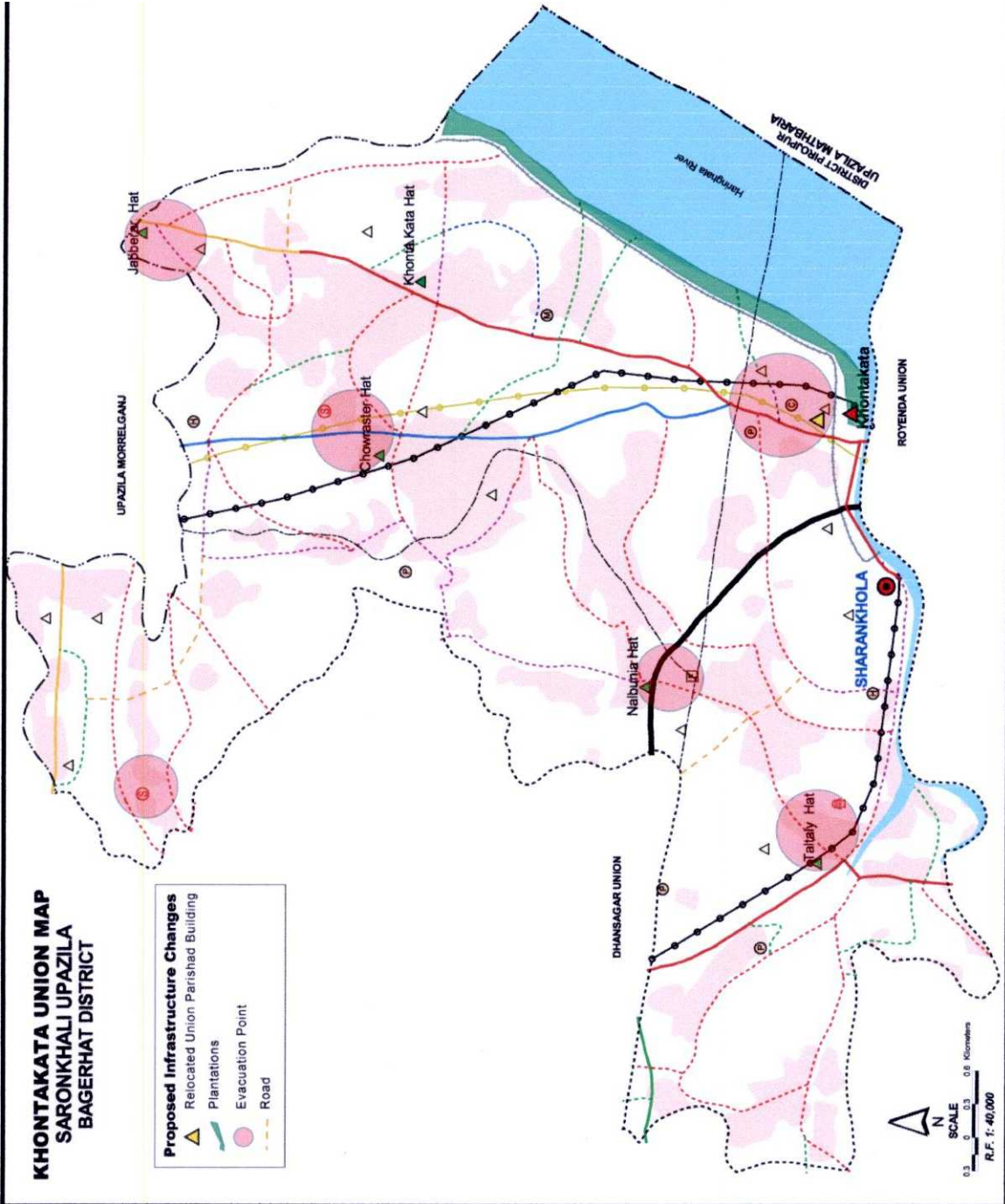

7: Suggested changes in the union



#### 4.4.2 IMPROVEMENT OF SETTLEMENT CLUSTERS

A planned settlement pattern can be introduced for communities following land use pattern and the inherent organic growth quality. This may not be very formal and rigid, but it should take care that the positive aspects of the place is more integrated in the planning and the weakness and threats are remedied. Growths influenced from the core or the inherent qualities and integrated with the surroundings can be encouraged than imposing ideas that do not match. Then sustainability of the growth and regeneration of the built space can be ensured.

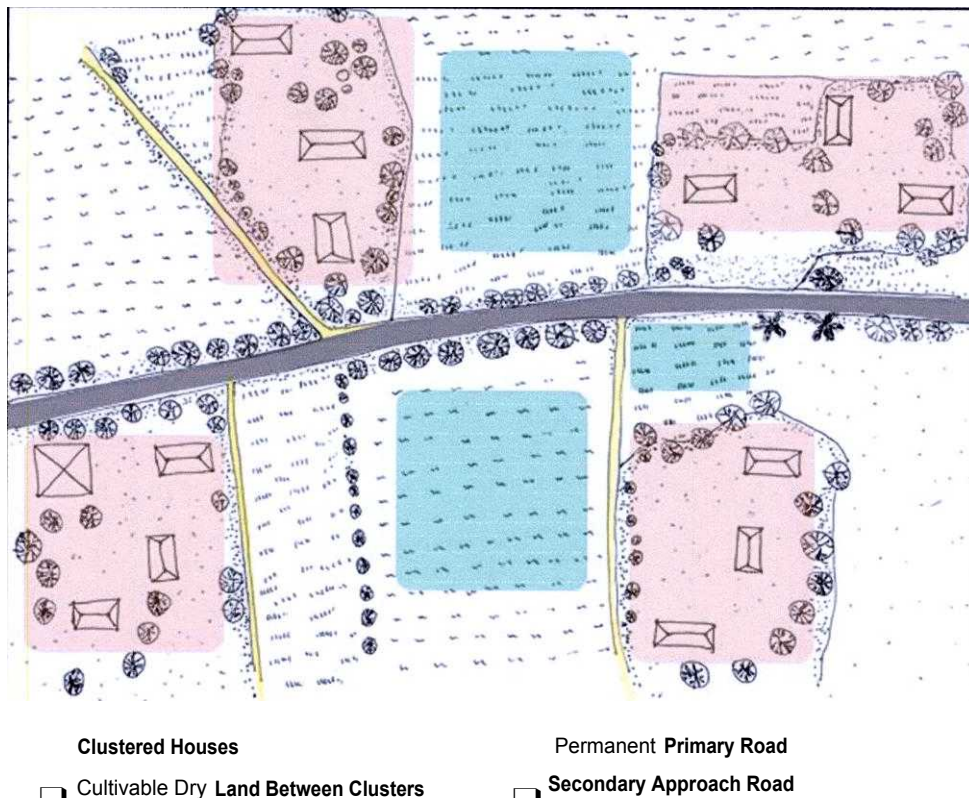

2: Arrangement of elements in a community

The physical planning should be integrated with the economic development of the place. Attentions are needed in employment practice and opportunity, different tiers of social relations, cultural factor, gender divisions etc. For example, working distances within the community or near it like cropland, river, bazaar etc; grouping of neighbors and relatives in the community; security and freedom of females inside the community from neighbors and outsiders, personal spaces of inhabitants etc need to be taken care. Settlement planning should be encouraged upon participation of the dwellers in defining spaces to enhance ownership.

### 4.4.3 ROAD NETWORK

Good road network is necessary for the communication with the different units/ clusters of the community, the nearest possible help centers and the outside world. The total road network should be accessible throughout the year, and built with permanent durable material. Connection of all the important structures with proper approach should be ensured; especially those that will play lead role in the immediate evacuation, rescue and relief activities; for example hospitals, cyclone centers etc. A thorough planning of primary, secondary and smaller arteries should be provided which will connect all the homesteads, so safe evacuation with cattle and other movable belongings is possible for the inhabitants without any difficulty.



This cyclone shelter lacks a proper approach with the road and is isolated from settlements (source: <http://www.sullivan.net/>)



Bridges of bamboo plank and pole are used in many places of the country that can be used here too (source: author)

#### 15: Considerations to check in road network

The roads need to be safe to travel during the evacuation, for example it should be taken care that branches of trees or C I sheets do not damage people while evacuating, the roads do not get muddy and unsafe in torrential rain before cyclone etc. Plantations beside the roads should be chosen wisely. Palm trees are better as these do not break in wind easily; date palm trees will be better too, but the thorny leaves can hurt people. Trees with shallow root and soft branches should be avoided

Metal panel prefabricated small bridges like military constructions that are easy to make and dismantle can be used over the water ways that do not face adverse erosion. Bailey bridges can be a good option. These can be customized in load capacity, width and length according to needs. These will allow transportation of vehicles as well as pedestrians. These will be cost effective and durable in terms of maintenance and local climate. Bridges of bamboo planks and poles with enough widths can also be

effective if these are maintained well. These were not seen in the locality as bamboo is scarce here. These connecting points will be very effective for females to travel both during normal and disaster time.

**These can be installed and maintained by government or private organizations working there. It had been observed in the study area that earth cutting work for some of the damaged roads had been implemented by NGOs. If work like these is distributed to NGOs to carry out with monitoring from the Local Government Engineering Department (LGED), then the burden of reconstruction will be reduced for the government.**

Road network can eventually bring other utilities to the neighborhood like electricity, better physical infrastructural growth, better communication etc.

#### **4.4.4 LOCATION OF AMENITIES/ UTILITIES**

Location of amenities acts as focal point in a community. For example, a water source connects several homesteads; a bazaar or growth center connects some communities; a boat/ ferry terminal connects some settlements of the both banks. Amenities are major factors to shape a community.

People should have easy access to utilities like drinking water, electricity etc. The location of PSFs should be able to serve the neighborhood in small clusters. Electricity extended with the road network can cover the settlements in maximum extent. It can promote growths of small workshops like sawmills or shops beside the roads. Better utilities can serve well in rescue, evacuation and news dissemination. The position of bazaar, hospitals, schools etc can divide a community in smaller groups, so during disaster these can play major role in preparedness and response activities.

The growth centers can play immense role in disaster risk reduction. It is a normal practice that amenities like post office, *thana*, colleges, hospitals etc are situated in the growth centers. The built environment is better here than the surroundings. So people often evacuate to the growth centers in need. These places can be developed in a compact township manner with maximum services to serve for disaster and normal time use.

## ***4.5 HAZARD RESISTANT/RESILIENT HOUSE***

### **4.5.1 SINGLE FAMILY HOUSE**

Family is the basic unit of society, and dwelling house the basic unit of community. Often after a major disaster, the inhabitants are forced to return to totally destroyed surrounding with no place to live. Then rebuilding process from scratch becomes very hard for financial shortcoming and after effect of trauma.

The houses are desired to be strong buildings to be resilient to withstand hazards. There is need to store the assets left there during evacuation, so the dwellers returning afterward can get these mostly undamaged. These should be easy to construct and repair, cost effective and durable.

Houses most vulnerable to cyclones are lightweight structures, especially older buildings with deteriorated and weakened condition. Whether a building is able to withstand wind load does not very much depend on the materials, but the manner in which these are used. It can be assumed that indigenous and locally available materials would be mostly used; good quality, ties and joints in the components need to be strong.

The options of "Building for Safety" approach would be the best solution for the local context. Providing different design and construction solutions would be better than suggesting a prototype model, so the inhabitants can choose according to their needs and abilities.

The construction of different components of a house would need special attention. Some of these are as follows:

#### **a. SITE PREPARATION**

**A proper site needs to be selected for homestead planning.**

- **It has to be above the inundation level (or flood level) from the surrounding. Natural drainage slope and drainage channel connections are needed for the climate of here.**
- **It should have clear and easy access to the connecting road that can function all year round, especially from gender point of view.**

- Soil retaining plants like betel nut, palm, and date palm have to be planted around the homestead. This helps against erosion and in boundary demarcation. Trees for fuel and construction also need to be planted around the homestead in personal property land. But care should be taken that these do not fall and cause harm in high wind. These should protect the house from strong wind. Tall trees have to allow enough sun around the house. Grass has to be planted between the open spaces to retain soil.
- The edges of homestead boundaries can be reinforced with small walls of banana or betel nut trunk to prevent breaking down. Water hyacinth does not grow well here. Local varieties of reeds in the edges of homestead boundary can reduce erosion.
- The open spaces around the house should remain workable and not muddy in the wet seasons. Sand can be mixed with soil to improve this condition. Ramming of earth is essential for the compactness of soil.
- Usually house repairs are done during March-April in the *golpata* collecting season. Site preparation and repairs can be done then before the rain comes.

#### b. STRUCTURE

- The full structure of the house needs to be tightly anchored with the base with proper resistance against wind.
- The joints with the each element (like base and columns, columns and horizontal frames, frames and roof etc) need to be strong.
- Cross bracings make the members stronger against force, and help to reduce damages.
- Smooth outer layer in the house helps to pass the wind unhindered without creating abrasive force in the materials.

#### c. HOUSE SHAPE

- A regular shape that does not create any wind pocket is better.
- Longer side of the house should not face the wind direction, so it gets less wind pressure.
- House shape can get gradually complex starting from the basic one room unit to adding verandahs at sides, to adding more rooms in the core and verandahs

**surrounding as separate unit in *pashchati* manner** (Seraj, S. M. and Ahmed, K. I, 2004).

- The core rooms can grow vertically **and add another storey to the house.**

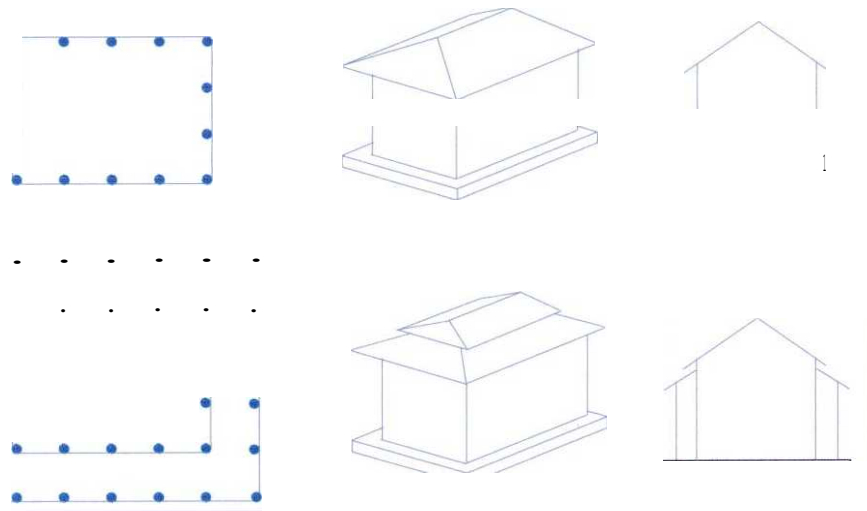

**3: Gradual addition of forms in a typical house structure**

#### d. PLINTH

The common material used in the locality for plinth construction is mud. Mud is abundant here, but the repairing takes time and labor. Nothing is mixed with mud to increase the stability. It is hand rammed thoroughly to prepare the plinth.

- A common practice in different places of rural area is mixing rice husk or straw with mud to increase strength, so the soil is not easily washed away in rain. As this area has abundant trees, dry saw dust can be used as a test.
- Curing with wet jute mat and regular water treatment would increase the stability. Ramming has to be done thoroughly.
- Adding asphalt or cement with mud makes it strong too. About six inches of capping of the plinth with cement makes it stronger and more damp proof.
- This can be done by adding 5% of cement by volume with earth both in dry condition, mixing those well with water, and applying over the prepared plinth (Mallick, F. H. *et al*, 2007; Ahmed, K. 1, 2005).
- Using brick boundary around the plinth is a good approach to retain it. An example of it is Brac relief house.

Another approach for house construction can be raising the structure on stilts. This is observed in the tribal villages like Kuakata that also faces strong wind hazard. But people do not feel comfortable with higher living places in this culture. An approach can be raising the house frame two to three feet from the ground and making the house on wooden platform. Mud steps can be used in front of the house instead of wooden ladder, so people would not feel too much alienated with it. Joints with the platform and pillars supporting the frame need to be strong.



**16: House frame on stilts**

#### e. FOUNDATION

Strong foundations are essential as the uplift force of cyclone can pull structures out of the ground. Though it was observed from the earlier constructions that houses rested over plinths rather than anchored with it, the heavy weight of these helped to resist the wind load. The earlier houses were mostly constructed with natural materials like wood, straw, sun grass etc which made the whole structure heavier. But houses have become smaller in size at present for smaller family size, high cost of land and house construction. Building materials like C I sheet etc make the structure lighter too. So these become more susceptible to get blown away and damage.

- At least four strong columns at corners make a structure stronger against high wind.
- Wooden columns get decayed and become weak. RCC columns with metal joint at the base make these stronger to support the structure firmly (Ahmed, K. 1, 2005).
- Foundations of columns need to be deep because the lighter the building, the heavier or larger the foundations need to be to resist strong wind.
- Brick or cement concrete base would be more durable than wood base.

#### f. WALLS

Wind creating pressure on the windward side and suction on the leeward side of the structure **causes** the walls to get blown away.

- Walls need to be of durable material with less wind holes. Bamboo or sun grass mats should be of dense weaving. Repairing should be done from decays before hazard season.
- Treatment of wall **material** with kerosene (Seraj, S. M. and Ahmed, K. I, 2004), or petroleum kind oil for protection from insect and decay.



4: Lateral wind force on wall (source: Agarwal, A, 2007)

#### g. OPENINGS

- **Openings at the corners make the structure more susceptible to damage. These should be at the middle portion of the building.**
- **Openings at opposite walls make way for wind and water to pass quickly doing less damage to the structure.**
- **Lintel/strong frame at the sill level and bracing above and below doors and windows make these strong.**

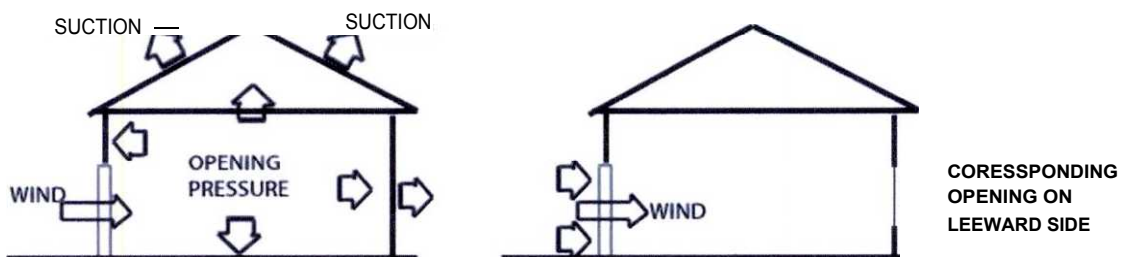

5: Suction for unequal wind pressure (source: Agarwal, A, 2007)

#### h. VERANDAH

Open verandahs increase wind load on the roof making it to blow away. Suspended eaves on verandahs and main house also increases wind load.



- **Verandah roof can be constructed as a separate entity so it does not affect the main roof structure.** The roof slope should coincide with the main roof slope.
- **Rafters and purlins can be placed densely for the open plan verandah.**
- **Open verandahs at all four sides increase wind load manifold.** So this should be avoided.
- **Depth of a verandah should be accordingly with the main house form. It should not be too deep in any case.**
- **Cantilevered verandahs and rooms at the upper floor were observed in larger houses in the study area.** These often make imbalance in the frame and increase wind load. These should be avoided.

#### **i. ROOF**

Roofs are the most vulnerable component in strong wind. Roof shape and slope affect the pressure or suction of wind on the structure. Projection of eaves increases the uplift pressure of roof. Holes in the outer walls to place rafters create wind tunnels inside the roof section that damages the roof.

- **Hipped (*chouchala*) roofs are better in cyclone resistance than gabled (*dochala*) or lean to (*ekchala*) roofs.**
- **Minimum roof pitch should be 25° to reduce effects of suction and uplift by wind (Mallick, F. H. *et al*, 2007).**
- **Overhangs should be according to the overall size of the roof and the whole structure. Nevertheless it should not be more than 2.5 feet (Mallick, F.H. *et al*, 2007).**
- **C I sheet should be properly anchored with frame at every corrugation.**
- **Rafters should be placed at maximum of 3 feet center to center; and purlins at maximum of 1 foot 6 inches center to center (Mallick, F.H. *et al*, 2007).**
- **Extra purlins are needed at the edges, on the top and the end of the roof, these are more susceptible to damages in high wind.**
- **Cross bracings are needed for large span roof frame to make it strong.**
- **Joints should be strong with roof frame and vertical frame.**
- **Threaded and or twisted screws for roofing should be used.**
- **Ridge of the roof should be secured with capping.**

- Straw roof may be covered with wire mesh and tied with adjacent strong support, like tree or poles with strong foundation as a precaution before cyclone season.
- Steel gusset at the ridge makes it strong. (Figure a)
- Rafters should be nailed from sides. (Figure b)

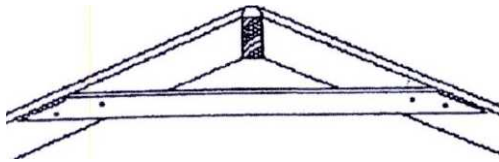

a) (source: Agarwal, A, 2007.)

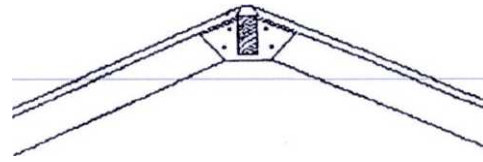

b) (source: Agarwal, A, 2007.)

#### 6: Roof construction details

#### j. JOINERIES

Safety of the construction lies mostly on the connection details. Structures become more vulnerable for poor and deteriorated joints.

- Cross bracings should be provided in the structure. At least the corners should be reinforced with vertical and horizontal bracings.
- Z bracings in door and window shutter can be introduced.
- Metal clamps and screws should be used in the joints to reinforce these.
- Simple timber joints like tenon-mortise, dovetail etc should be used more in the structures accordingly than depending only on nail joints.

#### k. CALCULATION IN SPACE STANDARDS IN HOUSE DESIGN

The constructions in the locality can be such that **the measurements can be related** with the **local units and international** standards. For example,

According to Sphere Standard the minimum covered floor area per person is 3.5 square meters (Comparison of Camp Planning Standards and Indicators as Published by the Sphere Project and UNHCR).

This is  $3.5 \times 100 \times 100 / 2.54 \times 2.54 \times 18 \times 18 = 16.74$  square *haat* in local unit.

If a family size is considered as = 5 persons,

Then required space for a house would be =  $3.5 \times 5 = 17.5$  square meters

Or =  $16.74 \times 5 = 83.71$  square *haat*.

This can be taken as = 84 square *haat* approximately.

If it is considered as II  $haat \times 8 haat = 88$  square  $haal$ ,

Then it comes to I I  $haat + 8 haat = 19 bandhokh$  to measure the house in  $bandhok$  method.

(If it is taken as  $12 \times 7 = 84$ , then the length of the house would be 12  $haat$  which is not an odd number. So the measurement cannot be changed into  $bandhok$  method here).

#### **4.5.2 LARGER HOUSE AS SAFE HAVEN FOR NEIGHBORS**

Larger houses in the community can come to use as safe shelters for the neighbors during disasters. Though the study area lacks such houses it was a common practice in the rural area in the past to have large two storied houses of the wealthy with larger joint families. These were built with timber mostly; nowadays these are of timber, brick or C I sheet wall and C I sheet roof. More wind load is exerted here for the larger size, height and exposed walls. Though the house follow the same quality of bioregion, the main house form do not follow the characters of smaller *kutch*a house in materials, construction techniques etc. These need more reinforcements to be cyclone resistant. As these require more capital to construct and repair, the return period of disasters and life of structures should be considered beforehand. Some of the features here would be similar with the single family houses for the living practice, environment etc like site preparation, door and window placement etc.

##### **a. HOUSE SHAPE**

The house shape follows the typical shape of here like a large box without stilts. The upper floor can be used as safe haven in cyclone. Though both the stories would be used by the dwellers, the upper storey can be used to safeguard the neighbors with their valuable movable assets.

- The shape should not create any wind pocket.
- Height, width and length should have a relationship with the whole structure, so wind load is evenly distributed.

##### **b. PLINTH**

- The plinth of large houses should be of brick soling with cement finishing; for these need to be more durable.
- Plinth should be raised high so the inside of house is safe against rain water.
- Damp proofing and salinity treatment has to be done.

##### **c. FOUNDATION**

- All exterior walls and interior load bearing walls should be supported on reinforced concrete footings. The foundation should rest on thick stable soil. If needed the soil under the foundation may be compacted, or mixed with hard aggregates to increase the stability.

- The foundations should be placed deep enough.
- The land chosen for erecting the house should not have water channels in the vicinity, so the foundation does not have scouring.
- If timber frame is used, it should be reinforced properly underneath the plinth with metal hooks.

#### d. WALL

- C I sheet wall makes the structure very light. Timber or brick wall would be better for the size of the structure.
- RCC frame can be used with brick wall. This would increase the strength and durability of the structure.
- Lower portion of wall should be damp proofed.
- Brick walls can be reinforced with metal wire mesh.
- Corners of brick wall can be reinforced with bended bars joined with one another.
- Hollow brick with reinforcement can be used.

#### e. ROOF

- In RCC roof adequate reinforcement should be done, or else failure of roof would make the structure to collapse.
- C I sheet roof may be more vulnerable for the height and large form. These should be adequately anchored and braced. Thicker C I sheet would increase the weight.
- To increase the weight of roof a suggestion may be to construct it with timber shingles. C I sheet may be used on top of it as a screen to protect the timber from weather effect.

**The need for stronger houses to act as refuge for the community is experienced after every large disasters; it is felt after the cyclone SIDR as well. It has been experienced that *"Progress can probably be most effectively achieved by integrated community flood management (including storm surge protection) and better housing standards. For cyclones, this can probably best be achieved by development and mass production of low cost, standardized housing components that raise the first floor above frequent flooding levels and strengthening the envelope against wind. This is a***

*significant development need for Bangladesh"* (Government of Bangladesh, 2008).

Considering this concept, different models of stronger houses to act as refuge in the community can be proposed.

### Hypothetical Design of a Large House as Safe Haven:

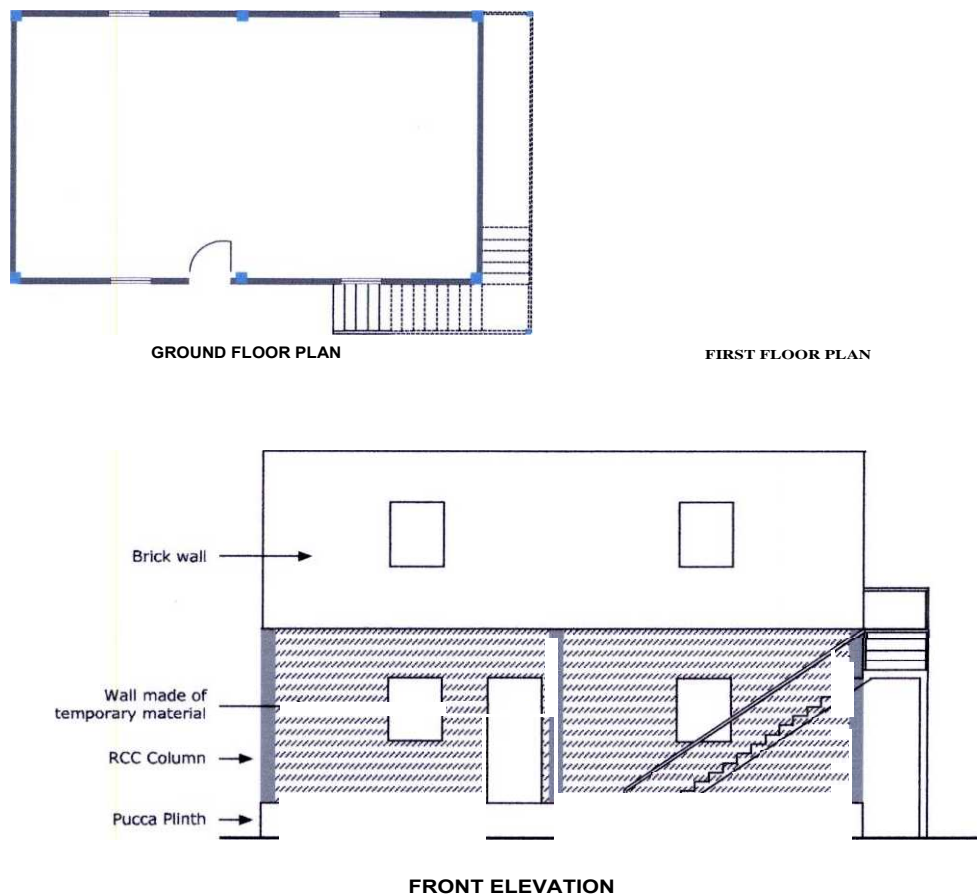

**11: hypothetical design of a large house as safe haven**

Different considerations in this hypothetical design are:

- The plinth can be of pucca material construction, so it will not be damaged in flooding.
- The house can be of RCC frame structure.
- The ground floor walls can be of temporary materials (like bamboo mat, timber wall etc) instead of making an open ground floor. The ground floor space can be utilized as dwelling thus.

- The first floor walls can be of thick brick wall. This floor can be used a refuge place in times of disaster.
- An open staircase can connect the two floors with the minimum circulation distance (for example, entry doors at the both ends).

According to this hypothetical design:

According to Sphere Standard the minimum covered floor area per person is = 3.5 square meters (Comparison of Camp Planning Standards and Indicators as Published by the Sphere Project and UNHCR).

This is  $3.5 \times 100 \times 100 / 2.54 \times 2.54 \times 18 \times 18 = 16.74$  square *haat* in local unit.

If the house is designed for = 15 persons per floor,

Then required space for a house would be =  $3.5 \times 15 = 52.5$  square meters

Or=  $16.74 \times 15 = 251.1$  square *haat*.

This can be taken as = 252 square *haat*.

If it is considered as  $21 \text{ haat} \times 12 \text{ haat} = 252$  square *haat*,

Then it comes to  $21 \text{ haat} + 12 \text{ haat} = 33 \text{ bandhokh}$  (an odd number) to measure the house in *bandhok* method.

So though the house may have different construction materials and will be used for different purposes, the usable spaces here can be converted to *bandhok* method.

During crisis time,

If allowed space per person is considered as 4 square feet,

The upper floor of this house can be used as safe refuge for =  $21 \text{ haat} \times 12 \text{ haat} / 4$  persons

Or =  $31.5 \text{ feet} \times 18 \text{ feet} / 4$  persons

= 141.75 persons or 142 persons (if there is no space wastage for furniture).

## ***4.6 SAFE BUILDINGS***

The permanent structures of the community that are used for public service like schools, mosques, NGO offices, transport terminals, government institutes like post office, police station etc can act as safe havens for life and property if these are considered safe against disasters. The construction of these in the first phase and/ or strengthening in later times following standards can allow for evacuation and short stay. The inventory and catchment area need to be analyzed. If these are decentralized or more dispersed in the community, maximum area and maximum population can be served.

### **4.5.1 CONSIDERATIONS FOR CONSTRUCTION OF PERMANENT STRUCTURES**

The requirements for selecting site for safe havens may be:

- Look for high ground to avoid surge and flooding. Adjacent river or canal regular flood levels should also be considered.
- Avoid river erosion. Location of other existing significant hazards should be considered if any.
- Natural drainage provision should be given priority for the normal monsoon rain and heavy rain during cyclone.
- Find vicinity with the community. Distribution of density of population and size of the catchment area will affect this.
- An inventory of permanent dwelling houses can influence site selection. For example, these can be where there are more temporary houses, which mean more vulnerable people.
- Access should be easy and short so people can reach there before, during and after the disaster; roads should not be submerged after flooding.
- Plant wind and surge breaking trees near the site, but not too near to avoid accidents in strong wind.
- Consider earthquake and tsunami resistance of the structure as well.
- Space should be left for future expansion; vertical expansion will be more feasible.



**The structures will be used according to the required function for normal time like schools, mosques, hospitals, offices etc. But the regular function and use as safe havens in disaster time should not conflict the design or layout of the space. The design criteria of these will be based on the followings:**

- **Functional considerations,**
- **Climatic considerations,**
- **Layout and spatial considerations,**
- **Shape and formal considerations,**
- **Behavioral considerations, and**
- **Typological considerations.**

(BUET-BIDS, 1993).

The structures should have some qualities like:

- Structure should be compatible with Building Codes and Risk Mapping.
- Form, size and orientation should be chosen considering disasters. For example, a long building will face more wind and surge load in the walls facing the loads; a long continuous building will be more vulnerable to earthquake etc.
- Flood and rain water clogging should not occur inside the compound and building.
- The external sides like doors and windows should be able to resist wind debris loads like blown C I sheet, trees etc.
- Design should avoid elongated hollow spaces so wind load is not increased.
- There should be proper ventilation as large number of people will occupy it in the time of disaster. People should not get a sense of claustrophobia.
- Heat trapping should not occur from the surrounding environment or from the accumulated body heat of the people inside the building.
- Maintenance and management should be comparatively easy.
- Fire safety and other safety provisions should be considered.
- Materials should be chosen wisely. For example, light materials for walls are better for earthquake damage prevention; heavier materials in roof make it better to resist wind.
- Elevated buildings are better against cyclone and tsunami wave damages. Buildings with stilts can be an option.

- Cross bracings should be provided for tying columns.
- Openings in the opposite walls let the water pass with less damage to the walls.
- Foundations should have strong footing. Anchoring of materials should be strong.
- Tie beams at plinth level prevent displacement of foundation footings and scouring in tidal waves.
- Vaults, arches, domes etc can be used as different design approach.
- Brick arches can be used instead of lintels to reduce cost. These should have enough strength to hold the structure in high wind.
- Joints in the materials and the members should be strong.

**Cyclone, tsunami and earthquake exert lateral load on the structure . So enhanced lateral load carrying capacity is an advantage . Tie beam at window sill level and above window can enhance resistance for lateral loads. Cyclone creates uplifting force on the roof. Anchoring the roof with the roof and wall frames helps to resist the uplifting. A continuous lintel will increase the resisting force.**

Single and two storied buildings have tendency to amplify the acceleration in seismic force. Increasing stories in buildings reduce this effect. Keeping all the components of a building intact will reduce casualty and damage. The ability of a house to remain as one unit will resist the force of earthquake when the masonry units are of sufficient strength. Tie beams help to achieve this, especially tie beams in the plinth level. Deep foundation will help against damage in liquefaction (Amirthasealan, *C. et al.*, 2006).

#### **4.6.2 COMMUNITY BASED CYCLONE SHELTER**

From the past cyclones it can be experienced that cyclone shelters have saved many lives. It was observed in cyclone SIDR that all the shelters were full beyond their capacity. But unfortunately, there were areas where no cyclone shelter existed, and people needed to take refuge in trees or could not take refuge at all. For example, there are no cyclone shelters at or near the study area. Some of the existing cyclone shelters in the coastal regions had been damaged by the past cyclones, the tidal waves and weather phenomena; some were built during the early seventies and lack sufficient maintenance.

The need for more shelters can be noticed from the assessment report of cyclone SIDR, *"Initial information suggested that the number of shelters was inadequate to accommodate the number of at risk communities. Further, some communities were expected to walk long distances to find shelter space. Many did not seek shelter because there were no facilities for the cattle and other livestock. More shelters are required however design and construction should consider a full risk analysis of the area. Consideration of gender facilities, amenities for people with disabilities and additional space for sheltering livestock must also be factored into the design phase. There is also a view that more community shelters should be built rather than larger shelters that are expected to service a number of communities or unions. A large number of shelters were reported to be in need of significant maintenance and in some cases rebuilding"* (MoFDM, 2008).

**Lack of shelter in an area can be a cause of internal migration. Smaller shelters to cover smaller communities can be a better option which would decentralizes the high pressure on the larger shelters during crisis time. These can be maintained and owned by the community.**

After the evaluation of the recent cyclone SIDR it has been observed that:

- An additional 2000 cyclone shelters are needed.
- Appropriate design and access for children, women and people with disabilities has to be ensured.
- Locations have to be determined considering density, vulnerability and geographical distribution.

- construction should be taken into consideration on risk mapping and other prediction models based on an all hazards approach, i.e., shelter design would consider such hazards as storm surge, cyclonic winds, flash flooding, tsunami and earthquake.
- Animal shelters (Killas) should be built.
- Fund requirement is about US\$ 200 million.

(MoFDM, 2007).

Community based cyclone shelters can serve better the needs mentioned. These can work out the potentials of.

- Community spirit and neighborhood feeling in ownership and maintenance.
- Better security of assets left at home as people will need to depart a small distance from their houses and will return soon after the crisis time.
- It can give social protection to the adolescents and women as neighborhood feeling will work here and all will be under the guidance of their guardians. The larger cyclone shelters often lack these qualities for overcrowding from large area.

The socio-economic benefit from here can be:

- A maximum potential unit in community development from the normal time alternate use. A suggestion can be that female headed entrepreneurship/ work generating/ health and nutrition/ or cooperative activity can be run here. If females are considered as hub of the family, they can encourage the rest of the family to participate in this institute.
- Accessibility to every class and creed of the society for the normal time use; it would not alienate any particular group.

**The functional elements to consider can be:**

- Try to **provide more than 2 square feet per person because staying time can be like 2 to 3 days depending on the situation . It may be that after a catastrophic disaster, the inhabitants are forced to live inside the shelter for the deterioration of the environment . It is a usual practice to provide 2 square feet per person in the larger shelters.**
- **Special provisions for the new born, new mothers and older persons.**

r uuu wuicug auu preparauun space.

- Better toilet, gender consciousness.
- Enough drinking water storage even if cyclone damages the drinking sources.
- Sphere standard/ other standard can be used to calculate food, water etc storage provisions (Gloor, H. and Sarkar, A., 2007).
- If possible space provision for assets can be managed inside the shelter.
- Provide store for immediate accessories like blankets, emergency medicines, life jackets, baby food, batteries, torch lights etc.
- Provision of mobile-internet, wireless, mobile phone connections.
- Extra source of water like pond, PSF tank, tube well etc at the vicinity of the shelter will be a plus point.

# Hypothetical Design of a Community Based Cyclone Shelter



Rain water  
rage tank

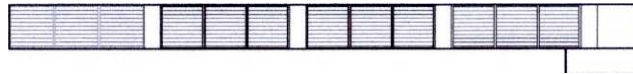

Glass block  
Metal shuttered  
doors & windows

DODO  
OOOO  
DODO

OOOOOOO  
□ 0111100  
01100000

t

12: Hypothetical **Design** of a Community **Based** Cyclone Shelter

- Considering 4 square feet per person this shelter can accommodate approximately 1500 to 1600 people. The service spaces (kitchen, toilets, store, staircase etc) are excluded from this calculation.
- Doors windows may be of steel/ wood/ strong metal sheet.
- Glass blocks used in walls to ensure natural lighting (Gloor, H. and Sarkar, A., 2007).
- Storage of rain water in the roof tops for the toilets.
- Non slippery material with rounded skirting can be used in the floor with water outlet pipes for drainage.
- Emergency toilets with holes in the floor slabs. Water provision and privacy need to be ensured.
- If possible provide piped water for drinking and cooking; so additional space is not used in the floor area for water storage.
- Segregation of toilet block and kitchen for hygiene purpose.
- Space division barriers/ walls can be of temporary type with temporary materials like hardboard partitions so these can be changed according to needs.
- Verandahs at both sides can serve as wind and sun barrier.
- Covered and walled staircase space can increase the covered floor area of the shelter. Stairway with short flights may be considered to move easily.
- If possible stairway and toilet walls can act as blocking elements in the ground floor against wind and surge. This block can be made facing the water channel of the region. The toilets here can be used in the normal time.
- Open ground floor can serve as shaded area for different activities of normal time.
- *Killa* can be of semi permanent materials, like brick soling and mortar.
- Small bushy shrub as fence can reduce surge velocity. Larger trees like *Babla*, Coconut can be wind barrier.

(source: Rahman, T, 2008).

NGOs have strong role in the community and people are familiar with different activities involving these. Many renowned large NGOs like Brac, Grameen etc have branches in many areas in the coastal region. There are also some NGOs that specifically work in the coastal regions. Some of these have their own land with office premise. So land acquisition for construction for the NGOs should not be a problem. The permanent structures of these offices can be used as safe havens during disasters.

Activities have increased manifold concerning relief and rehabilitation in the different NGOs in the SIDR affected areas. More space in the office premise is often needed for this. Extension of older buildings and construction of new ones can be focused on that these can be used as safe havens. An approach can be that if these offices are decentralized inside the settlements, then it will be accessible to the inhabitants of fringe areas for normal function and evacuation. This will attract road network, electricity supply, improve of land use pattern and other developments inside the settlements.

The considerations for constructions in the coastal areas can be followed here. Roof should be of RCC construction. It has been observed that existing buildings of many NGOs in the study area has C I sheet roof that were damaged in high wind and tree falling. Communication facilities like wireless, internet, mobile etc can be provided as NGOs can disseminate news better within the territory and outside help seeking places; these will help in the immediate rescue and relief activities.

Space should be provided for the storage of immediate relief items like dry food, blankets, oral saline, medicine, first aid kit etc, and items needed for search and rescue.



#### 4.6.4. SCHOOL AND MADRASSA

There had been a suggestion by the government after the 1991 cyclone to use the newly constructed cyclone shelters as government primary schools for the normal time in the coastal areas. The schools under this rule have building standards appropriate to be used as shelters, for example scope for vertical future expansion, space segregation from gender consciousness. Nevertheless it has been found that schools in the rural areas run under different managements, like community school, private schools, NGO schools, government schools, madrassa etc. The constructions of these are not under any common compulsory rule; so there are no obligations to construct schools following the government guidelines. Most of these are of brick wall and C I sheet roof construction, or C I sheet wall and roof construction. Some madrassa even have mud plinth. These are unsuitable as safe havens for a major disaster; physical conditions of these are poor too.

Schools need to be disaster safe building for their development roles. These play major role in restarting life and return to normalcy phase. It helps a great deal to the students to overcome trauma from a disaster.

Schools can act as safe buildings for staying during and after disaster for their social function and as these are more dispersed inside the community. As schools get funding and are run under a certain authority, standards and codes can be implied strictly here. Implementation of standards can improve the quality of built environment manifold. An example can be that, a voluntary group named AWARE built 1, 500 houses following the cyclone proof designs of Central Building Research institute in Krishna district in the coastal areas of Andhra Pradesh in India after a cyclone in 1977. These were of concrete block walls made of cement and granite rubbles, and reinforced concrete slab roof. Of these houses 1,474 withstood the stronger cyclone of 1999 (Benson, *T. et al*, 2007 in Sri, A.V. S. and Reddy, I.A. S. in Aysan, *Y. et al*, 1995).

The disorganized and poor growth of these should be restricted because often poorly constructed schools give false sense of security.

some rules that may be applied for schools as follows:

- These should be at least two storied with open ground floor plan. Though future vertical expansion provision may remain, if the present requirements are met from the ground floor covered area, people will not feel the need for future vertical growth.
- Materials should be chosen wisely. For example, C 1 sheet should be avoided as these make the structure very light. Roof should be of RCC construction, wall can be of brick or RCC framing.
- Vertical and horizontal circulation space should be clear and easy to use. Stair should be of non slippery material with user safe railings.
- Access should be easy from communities.
- These may aim smaller communities of the immediate surroundings.
- Care should be taken that enough space remains even after the regular sitting arrangements and furniture.

### Hypothetical Design of a School:

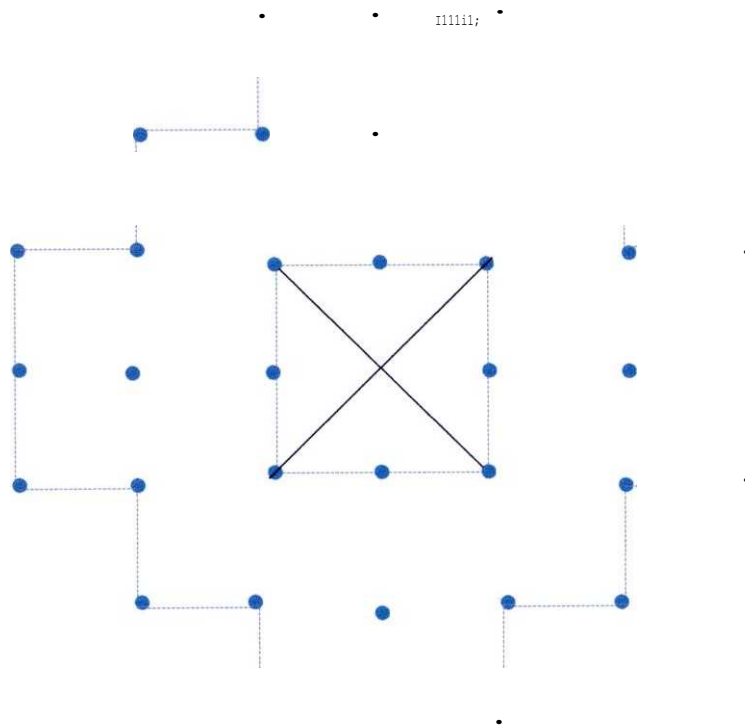

School - Ground Floor Plan

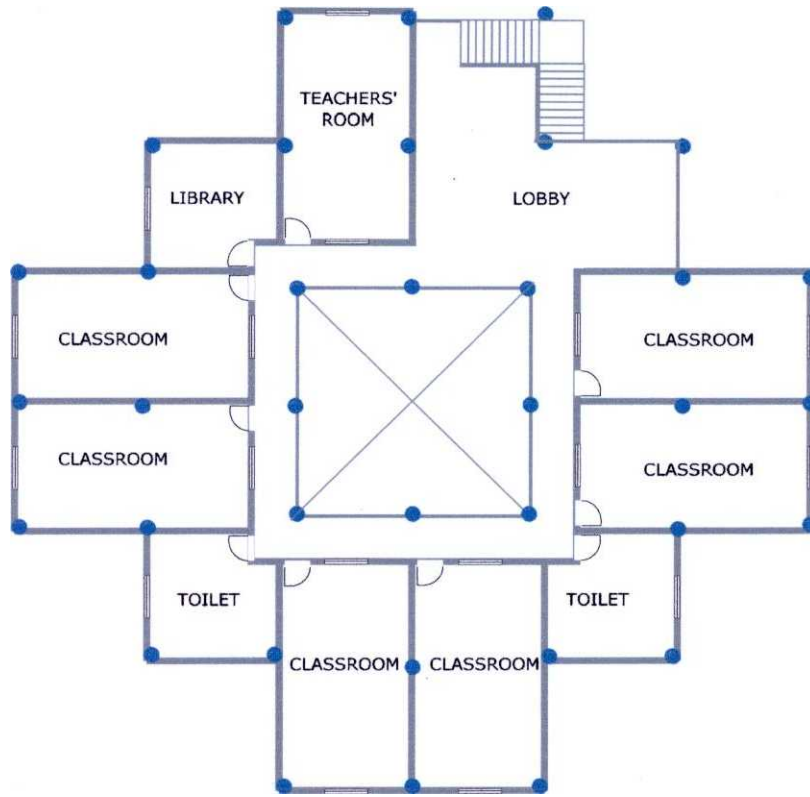

School - First Floor Plan

F7



Elevation

13: Hypothetical Design of a School

#### 4.6.5 MOSQUE

Most of the people in the study area are Muslims. There are a number of mosques dispersed in the community throughout the area. People have a tendency to relate themselves with religious structures and they use these daily. These community serving structures should be taken care by them for their own benefit. These should be strong enough to act as refuges during disasters, the approaching roads should be of good condition, and distance with settlements should be short. PSF or other water source near these will help improve the quality of life. As these structures have a distinct sentimental value, these can be improved and maintained by the community.

#### **4.6.6 KILLA**

Cattle are assets to rural people. Often people are reluctant to move to cyclone shelters as there are no *killa* with it. As a *killa* needs higher ground to house many cattle, number of these may be less but accessible from all the communities; it may be near the grazing ground. It can be located on a natural high terrain, so natural drainage is ensured.

*Killa* needs large proportion of earth filling work to raise a mound. Compactness of the earth should be maintained. Coarse aggregates can be mixed with the soil for retaining the earth. Sand can be mixed to reduce muddiness as cyclone brings torrential rain, and the hooves of cattle will create mud. Providing low brick boundary all around the *killa* will make it durable; as it is often used as grazing ground in the normal time. Grass needs to be planted so the earth is not washed away in rain in normal time. It may be very effective to cover the whole *killa* with wire mesh, but this may increase cost.

The open ground floor of a cyclone shelter can be used as *killa*. It will be better if safe refuge for large number of poultry can be provided. Raised ground floor of the permanent structures like school, NGO office can be used to store poultry with its dry food.

#### **4.6.7 GRAIN STORAGE WAREHOUSE**

Many people in the study area are engaged in agriculture. The harvests need storage space all through the year. Large quantity of food is also required for relief after major disasters. For example, the government sanctioned 3,000 tons of rice to the devastated regions following day after cyclone SIDR (The Daily Star, 17.11.2007). Carrying large amount of relief through the damaged roads and water ways becomes very cumbersome, especially immediately after the disaster.

Large storehouses in the rural areas may be a solution that can serve as government granaries during the normal time, and act as storage space for food relief. These will be helpful during the time when early harvest of crop is needed for weather forecast. For example, it was feared that people will need to cut Aman paddy early if cyclone Nargis made a landfall in Bangladesh during May 2008 (The Daily Star, 29.4.2008).

Different kinds of storage facilities may be needed for grain, seed, fertilizer, fish, dried fish, bulk supply of grocery stores etc, occupational tools like plough, shallow machine, fishing net etc according to different occupations.

Design consideration may be:

- The structure may have to bear concentrated load on the floor for stacking heavy sacks. Covered ground floor or semi basements can be an option than constructing it on stilts.
- Circular shapes may be good for avoiding surge damage. Walls need to be strong and thick.
- Large spacious staircase/ ramps will be needed. Manually operated pulleys can be used for loading and unloading.
- Adequate ventilation is needed to avoid dampness.

## 4.7 LANDSCAPING

### 4.7.1 COMMUNITY POND/ SOURCES OF DRINKING WATER

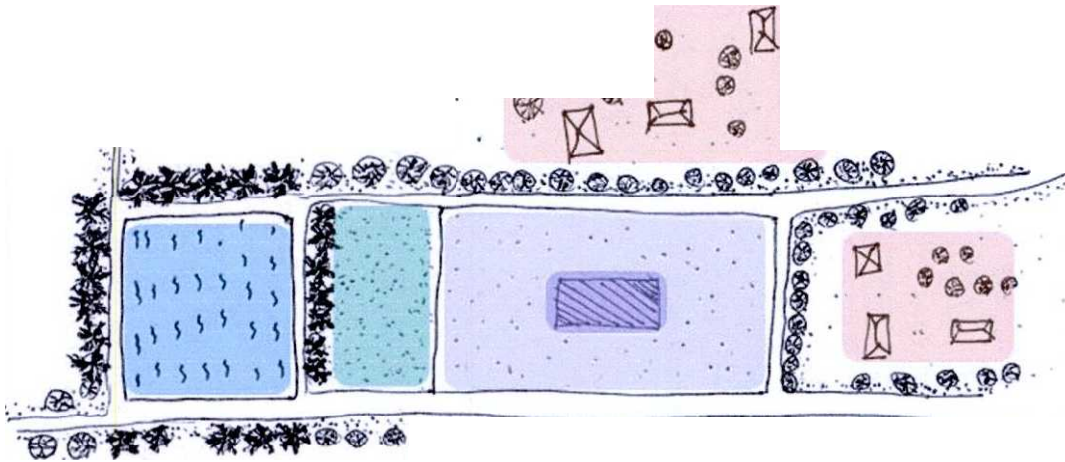

- Community Pond      Killa      Clustered Houses  
Grazing Field      Cyclone Shelter

#### 7: Location of community pond and *killa*

Community ponds can be near a *killa* as the excavated earth can be used in making a *killa*. It is often experienced that communities face acute drinking water crisis after cyclone, as tube wells get damaged and pond water gets degraded in decayed leaves and saline water. If these ponds can be treated as community property, people will be encouraged to retain its quality.

These ponds can be used to store rain water that can serve the community throughout the year. As there is drinking water crisis in the study area, ponds will be of great help to the locals. Soil retaining trees with large leaves should be planted around the pond like palm, coconut, betel nut etc. These can also act as wind barriers to the *killa*, if a *killa* is placed near a pond. Trees that are soft and break in wind should be avoided as these can contaminate water from damaged branches and leaves.

Sufficient number of Pond Sand Filters (PSF) to store rain water should be provided in suitable locations for better facilities of the villagers.

#### 4.7.2 COMMUNITY LANDSCAPING

Landscaping the settlements for breaking the storm surge in cyclones and tidal waves in tsunamis will reduce the impacts of it a great deal. It has been experienced that during cyclones many people perish and get injured for strong storm surge. Often people cannot fully understand or comprehend in advance the effect of high magnitude storm surge, and they drown in it when trying to leave the community for safe ground; this has been the case in cyclone SIDR as well (MoFDM, 2008). Saline water of surge damages the crop in field and the soil. This effect may not be estimated in the initial phase, but it makes long term adverse effect on environment.

Tsunami waves and storm surges become bigger and stronger running up a smooth shallow beach. But rough surface and high ground will break it earlier before entering into the settlements. Tunnel like openings in the path increases the force of the wind and waves. The banks adjoining mouth of rivers and canals need special attentions in landscaping and plantations. Human settlements immediately around it should be avoided if possible or extra security should be provided with early warning, evacuation etc.

Protection of settlements with earth mounds can act as wind and wave barriers. This can reduce the negative effects but not fully protect the damages. But death and injury may be reduced a great deal. These landscaping can be used to store rain water but care should be taken that it does not create water logging problem.

Embankments in the river banks can be protections to reduce the high waves created in weather disturbances besides storm surge. But covering the whole course of rivers with embankments will make inland water logging problem and degrade biodiversity. Dense plantation with local varieties will reduce this to a limit. It was experienced that *"A Vietnam Red Cross mangrove planting program implemented in eight provinces in Vietnam to provide protection to coastal inhabitants from typhoons and storms cost an average US\$ 0.13 million a year over the period 1994 to 2001, but reduced the annual cost of dyke maintenance by US\$ 7.1 m. The program also helped save lives, protect livelihoods and generate livelihood opportunities"* (Benson, *T et al.*, 2007 in IFRC, 2000).

Dutch style dykes in the coastal banks to reduce the future more intense cyclones may not be possible here as the soil formation is more of mud quality; the rapidly changing geological factors in this region make it a hard place to protect (Time, 19.1 L2007). So only one option to increase resilience or reduce mitigation against disaster will not be a feasible solution.

#### **4.7.3 TREE PLANTATIONS**

As the inhabitants of the study area have good habit of growing timber and fruit trees, and the environment suits this practice well too, this should be encouraged very much. Plants should be chosen wisely. The local varieties that are better for the soil should be given preference. Fruit trees around homesteads and beside roads can supply the need of vitamins and minerals of the community children. Monoculture or foreign varieties of plants that do not have much compatibility with the local environment should be restricted, even if these prove to be more economical within short time span like Ipil-ipil, eucalyptus etc.

It will not be feasible to think alternate energy like diesel or gas other than firewood for domestic use. So the regular supply of firewood from the local resources without degrading the environment should be ensured. It will be better if it also supplies a major portion of the natural construction materials.

There will always be pressure on land for agriculture, especially rice cultivation as staple food. Care should be taken that land encroachment for crop production does not destroy the wood coverage of lands. Again rice production will need protection against salinity; and extension of mangrove belts can act as natural barrier against salinity in the estuary regions.

The earthen embankments should be protected by plantation to prevent against erosion. Plants that have deep roots should be avoided as these make cracks in the soil and loosen it. But plants with short dispersed roots will help in **retaining** the soil. Bamboo does not grow well here for salinity. **But palm**, date palm etc can be grown on the embankment; these are also grown on the edges of cultivable lands to demark boundaries. It will be excellent to grow grass on the embankments as these will serve as fodder as well; this region lacks good quality of grass as cattle food.



#### 4.7.4 AFFORESTATION

Afforestation near the settlement in the fallow *khasjami* can be encouraged, especially the areas outside the embankment. It will be a barrier against strong wind, surge and tsunami waves, and it will prohibit habitation in this unsafe zone. Planting the local and forest varieties will be better in this aspect as an extension of the forest belt. Monoculture should be barred in all extent as it destroys the local biodiversity, degrades the soil quality etc. Mangrove plants can be encouraged to grow as it suits this environment, and will prevent erosion.

It can be suggested that as this area falls under the normal tidal actions, plants that are extensively used for construction (example *golpata*), fuel and food (example *kewra*) can be grown. It should also allow seasonal access for the collection of forest products, so the dependency on the main forest is reduced. It had been discussed with an NGO working there during the field visit that no initiatives had been taken by any authority ever yet to grow *golpata* near the locality, though there is extensive demand of it and the environment also suits it. NGOs working on forestry and on the people dependent on it can play roles here.

**Guidelines can be followed considering the Land Use, Land-Use Change, and Forestry in the local context; this may be considered as an afforestation or reforestation approach (IPCC, 2000). If possible the foliage coverage can be measured by GIS and carbon deposits can be calculated. This can help in gaining carbon credits and other climate deals that are recently being proposed (Reuters, 10.10.2008).**

The decision by UNESCO to let Sundarbans get time revitalizes to its original form and the restriction into the forest for collection of forest materials for two years has been a positive approach in this context (UNESCO World Heritage Center, 2007). This may also help to search alternate supplies from elsewhere or to go for afforestation in the localities.

Care should be taken in the conversion of forest land. Encroachment of forest land should be guarded for the villages adjoining the jungle directly by habitation, cultivation etc or indirectly by over collection of forest materials.

On the other hand, activities that will promote deforestation should be discouraged and alternate ways should be provided. Livelihoods like salt farming and shrimp cultivation that are more profitable lead to extensive deforestation. An example of it is Chokoria Sundarban in Cox's Bazaar district that used to be 21,000 acres of mangrove patch and was managed under the government forest department as reserved and protected forest. Now it is totally lost by 100% export oriented shrimp cultivation financed by Asian Development Bank, World Bank and United Nations Development Program. Though after the 1991 cyclone it had been tried to re-grow a part of the forest, but mangroves are hard to recover once these are completely damaged (Gain, P, 2002).

**Khulna- Shatkhira- Bagerhat areas or the southern coastal belt is also lucrative environment for shrimp cultivation for the brakish water in the estuaries . This is leading to deforestation and more vulnerability to cyclone and tsunami damages, as the forest absorbs some of the wave 's energy generated by these disasters . A study showed that areas in Pichayaram and Muthupet in Tamil Nadu state of India with dense coverage of mangroves suffered less human casualties and property damage than areas without mangroves during the 2004 tsunami (Padma , T.V, 2004).**

It had been assessed that the destruction in the low lying Irrawaddy delta in Myanmar from cyclone Nargis of 2nd May 2008 was massive for the absence of natural barriers. About 82.76% of mangroves in the delta were destroyed between 1924 and 1999 for shrimp farming and rice cultivation (Mangrove Action Project, 2008). Though climate change will increase the occurrence and intensity of cyclones in this region, protection of vegetations will be one of the best natural defenses.

## 4.8 CRITICISM

Local good practices in design and technical methods used:

	ELEMENTS	EFFECTIVENESS OF USE
1.	<b>One or two <i>Machal</i> platform over head height.</b>	<b>Increases floor space; helps as safe storage space against submersion damage.</b>
2.	<b>Door and window shutters operable from inside.</b>	<b>Can evacuate in danger as it will not get jammed from debris.</b>
3.	<b>Single unit house form .</b>	<b>Does not create wind pockets.</b>
4.	<b><i>Maitta</i> oil treatment on natural materials.</b>	<b>Prevents against weather effects.</b>
5.	<b>Use of <i>atchala</i> roof on larger structures.</b>	<b>Acts better to resist wind load.</b>

3: Local good practices in design and technical methods used

Technologies and methods that may be introduced:

	ELEMENTS	EFFECTIVENESS OF USE
1.	<b>Treatment of natural materials with chemicals (straw, bamboo etc).</b>	<b>Durable against weather damages, cost effective.</b>
2.	<b>Availability of natural materials that are not produced locally (bamboo, different sun grass).</b>	<b>Excess of natural materials from other places can be used, pressure on wood will be lessened, and sustainable use of indigenous materials can be managed.</b>
3.	<b>Use of long fibred timber (like palm, date palm trunk) for making load bearing frames.</b>	<b>Will be more durable, reduce repairing cost.</b>
4.	<b>Introduction of different building materials for construction of permanent structures (like hollow block, glass blocks, prefabricate building materials etc).</b>	<b>More options in construction, better space quality.</b>
5.	<b>Different techniques like reinforcement of brick walls, use of space frames.</b>	<b>Better resilience, better space quality.</b>

4: Technologies and methods that may be introduced

#### ***4.9 RELATIONSHIP WITH OUTSIDE AND INSIDE PARTICIPATIONS***

It should be remembered that the different options suggested in this dissertation regarding the structural strengthening of settlements are only some means or options. These are not the only solutions. These are some knowledge based suggestions. But the applicable knowledge here should be contextualized with people, places, their perceptions and practices. Otherwise the technology will not be disseminated and thereby it will not be sustainable. So the relationship between the outside people (with engineered solutions) and the inside people (the users with good practice based knowledge) should blend well. For this, the users need to select their solution from many options; the outside people need to understand the context of each place well. The application of the knowledge should not be forcefully implied or controlled. For this one has to unlearn the formal side of the situation first, and then integrate with it blending the both sides gradually.

#### ***4.10 RECOMMENDATIONS***

The context of Khuntakata gives an idea of the coastal settlements of Bangladesh with its potentials and future development scopes. It can be presumed that the physical improvements of the area will reduce the risks from disasters and enhance the standard of life. It should be remembered in the process that what works for a specific place may not necessary work for another place. The aftermaths of disasters are different according to the contexts. Every situation needs to be addressed uniquely and the solutions will come accordingly.

Some recommendations for the study area will match for the overall scenario of the coastal areas of Bangladesh. For example:

- **A clear but flexible action plan will help enhance the physical developments that can be implemented during the normal time focusing the disasters. This will reduce pressure on contingency fund used in crisis time. It is often experienced that development funds need reallocation to be used for rehabilitations (IEG, The World Bank, 2006).**

- Physical developments goals should be planned to reduce long term vulnerability reductions. Life span of structures and return period of hazards should be considered well with climate change effect precautions.
- The target community may be divided in different groups according to poverty levels and risk levels.
- There should be safety nets covering the middle income group who often gets adversely affected in disasters, but does not get the institutional rehabilitation supports.
- It may be better to implement the physical plans from available local investments rather than depend on foreign grants after every disaster. The corporate group of the country may take a significant role here indirectly by financing; and directly like tree plantation, schools construction, providing system support etc.
- Participation of all the stakeholders should be ensured in the rebuilding process to make the sense of owning and belonging more logical.
- Spending in some sectors should be considered as investments like making safe buildings for schools, hospitals etc; though returns from these may not be physically visible.
- Some long term goals may need to be implemented through loan distributions. Loan recoveries in these projects after disasters should be thought practically because disasters may be frequent for a region (IEG, The World Bank, 2006). For example, the offshore islands, or specific group of people like fishing community face frequent damages from sea.
- Village information kiosks can be introduced in the communities with internet and mobile phone provisions for early warning and news dissemination, need assessment, relief and rehabilitation activities etc.

- **There should be a common authority of the cyclone shelters concerning management and maintenance . Policies may need to be made for this.**
- **Standards and codes should be implemented on the buildings considered as safe building.**
- **Standards followed internationally like the Sphere Standard may be integrated in reconstruction phases. These should match with the local context , lifestyle and the faced situations.**
- **Sustainable use and management of natural materials in construction should be explored as much as possible . For example, experiment if 5% or more cement mixed with mud can be feasible in constructions like walls, reinforcement of mud walls can be durable , chemical treatment of natural thatching materials can be economical and durable in the local weather and hazards etc.**

## 5. CONCLUSION

The following issues were experienced in the study area considering the physical strengthening of community:

- Reconstructions activities carried there by different authorities need to be stronger aiming at disasters.
- There are no strong houses with permanent materials to act as safe refuges.
- Settlements need to be more precise and formal in growth.
- Road network inside the community needs improvements.
- Land selection for location of safe havens needs attention.
- Safe havens as refuge against disasters need to be dispersed inside the community to cover the maximum space. Developments in growth centers need to be of permanent quality to act as evacuation points.
- Schools of all categories/ authorities need to have common construction code and standard focusing on disasters.

Bangladesh has very limited land area considered to its population. From planning aspect it may always be a question that if providing housing and different basic **amenities** for all can be a possible or feasible option, though housing is a basic necessity. But safety of people needs to be ensured taking care of the benefits of both human and environment. Sustainability of the physical environment is important for the economic long term goals; and sustainability has to be blended with aspirations.

It can be said that a society can be judged how strong it is through the disturbed situations in disasters; how it shapes the far fetched ideas or goals. Major investments of a country are done in infrastructures. Disasters can hinder or wipe out development goals. Physically stronger communities can reduce the rebuilding costs, thus help the disaster reduction approaches from risk to resilience. Mainstreaming disaster risk reduction activities as integral component with development process will be a better approach than dealing it as a separate issue.

**It is recognized that Bangladesh will be adversely affected by climate change effects. The two strong and deadly cyclones SIDR and Nargis in two consecutive cyclone seasons can be taken as the harbinger of the future disasters. From Bangladesh**

perspective in this view, it may be said that natural disasters cannot be prevented, neither mitigated in large scale; but adaptations can be achieved and the measures should be strong. Introducing and improving stronger components in settlements to reduce loss of assets can be a logical mean of adaptation. This can ensure the quality of lifestyle and economic stability of a place and reduce the migration of people as climate refugees to large cities. This in a way will reduce poverty and reduce vulnerability to disasters.

Better integration of indigenous materials and local good practices with technical improvements in the reconstructive adaptation measures will ensure sustainability of environment and economy. Community participation in the disaster time is a unique character of the subcontinent. Stronger infrastructural developments can promote better the community based disaster reduction activities both during disaster and in normal time. In this aspect the growths should be aimed at better participations but not at community control.



## REFERENCE

Agarwal, A. (2007) *Cyclone Resistant Building Architecture*, **Disaster Risk Management Program**, Government of India - UNDP.

<http://www.ndmindia.nic.in/tcchAdvGroup/rvs/CycloneArchitecture.pdf>, accessed on 3.9.2008.

Ahmed, K. I. (2005) *Design and Construction of Housing for Flood- Prone Rural Areas of Bangladesh*, Asian Disaster Preparedness Center, Bangkok, Thailand.

Ali, M. H. and Choudhury, J. R. (nd) "Assessment of Seismic Hazard in Bangladesh" in Nizamuddin, K (2001) (ed), *Disaster in Bangladesh Selected Readings*, Disaster Research Training and Management Center, Department of Geography and Environment, University of Dhaka, pp 109-126, ISBN 984-31-1052-8

Amirthasealan, C, Thesoruban, P, Sugandhan, T, Muraleedaran, T, November (2006) *An Integrated Approach for Enhanced Disaster Resistance*, project report submitted in partial fulfillment of the requirement for IESL engineering course, Institute of Engineers, Sri Lanka.

[www.ktmuralee.com/My%20Project/Combined%20report\(io int\).pol](http://www.ktmuralee.com/My%20Project/Combined%20report(io%20int).pol) accessed on 21.10.2008.

**Bangladesh University of Engineering and Technology, Bangladesh Institute of Development Studies (1993) *Multipurpose Cyclone Shelter Program, Final Report*, UNDP/ World Bank/ GoB project BGD/91/025.**

**Banglapedia**, map of cyclone track, [http://banglapedia.org/Maps/MC\\_0397.GIF](http://banglapedia.org/Maps/MC_0397.GIF), accessed on 14.10.2008.

Banglapedia, map of Sarankhola upazilla, [http://banglapedia.org/Maps/MS\\_0095.GIF](http://banglapedia.org/Maps/MS_0095.GIF), accessed on 14.10.2008.

**Banglapedia**, map of storm surge, [http://banglapedia.org/Maps/MN\\_0131D.GIF](http://banglapedia.org/Maps/MN_0131D.GIF), accessed on 14.10.2008.

**Banglapedia, Sarankhola Upazilla, [http://banlapedia.org/ht/S\\_0095.HTM](http://banlapedia.org/ht/S_0095.HTM), accessed on 14.10.2008.**

**Benson, T, Twigg, J. and Rossetto, T (2007) *Tools for Mainstreaming Disaster Risk Reduction*, in Lewis, J. and Chisholm, M.P. "Cyclone-resistant Domestic Construction in Bangladesh" in Hodgson, R.L.P., Seraj, S.M., and Choudhury, J.R. (eds), *Implementing hazard-resistant housing*, Proceedings of the First International Housing and Hazards Workshop to Explore Practical Building for Safety Solutions, Dhaka, Bangladesh, 3-5 December 1996, Provention Consortium Secretariat, Geneva, Switzerland.**

**[www.bentidhrc.org/activities/misc\\_papers/Tools for mainstreaming DRR](http://www.bentidhrc.org/activities/misc_papers/Tools_for_mainstreaming_DRR), accessed on 2. 9. 2008.**

**Benson, T, Twigg, J. and Rossetto, T (2007) *Tools for Mainstreaming Disaster Risk Reduction*, in Sri, A.V.S. and Reddy, I.A.S. 'The cyclone-prone coastal region of the State of Andhra Pradesh, India - A state-government approach'. In Aysan, Y. et al, *Developing building for safety programmes: Guidelines for organizing safe building improvement programmes in disaster prone areas*. London: Intermediate Technology Publications, 1995, Provention Consortium Secretariat, Geneva, Switzerland. [www.bentidhrc.org/activities/misc\\_papers/Tools for mainstreaming DRR](http://www.bentidhrc.org/activities/misc_papers/Tools_for_mainstreaming_DRR), accessed on 2. 9. 2008.**

**Benson, T, Twigg, J. and Rossetto, T (2007) *Tools for Mainstreaming Disaster Risk Reduction*, in International Federation of Red Cross and Red Crescent (2002) *IFRC World Disaster Report: Focus on Reducing Risk*, Provention Consortium Secretariat, Geneva, Switzerland. [www.bentidhrc.org/activities/misc\\_papers/Tools for mainstreaming DRR](http://www.bentidhrc.org/activities/misc_papers/Tools_for_mainstreaming_DRR), accessed on 2.9.2008.**

Comparison of Camp Planning Standards and Indicators as Published by the Sphere Project and UNHCR, [www.humanitarianreform.org/humanitarianreform/Portals/1/cluster%20approach%20page/clusters%20pages/.../handoutDI](http://www.humanitarianreform.org/humanitarianreform/Portals/1/cluster%20approach%20page/clusters%20pages/.../handoutDI) . accessed on 28.10.2008.

Choudhury, J. R. (2008) "Risk of Earthquake, Tsunami and Storm Surge in Bangladesh and Mitigatory Measures", Keynote Presentation on the Launching Ceremony of the CDMP Earthquake and Storm Surge Preparedness Component, Dhaka, 6. 2. 2008.

Cyclone center picture, <http://www.sullivan.net>, accessed on 11.2.2008.

DESIGN PARAMETERS FOR INDIVIDUAL SHELTER. TECHNICAL WORKING GROUP (TWIG). SHELTER CLUSTER - MYANMAR NARGIS  
[myanmar.humanitarianinfo.org/Shelter/Technical%20Guidance/Final\\_DESIGN\\_PARAMETERS FOR SHELTER 020908.doc](http://myanmar.humanitarianinfo.org/Shelter/Technical%20Guidance/Final_DESIGN_PARAMETERS_FOR_SHELTER_020908.doc). accessed on 15.9.2008.

Earthquake zoning map figure, People's report 2002- 2003: Bangladesh environment, Pp 107

Gain, P (2002) (ed) "Fisheries", *Bangladesh Environment Facing the 21s` Century*, second edition, Society for Environment and Development, Dhaka, pp 107-127, ISBN 984-494-016-8.

Gloor, H. and Sarkar, A. (2007) "Community- Based Disaster Shelters and their impact on the Poor - SDC's Experiences in the Region, Technical Segment, Group B Theme I", Presentation on Mainstreaming Disaster Risk Reduction in Poverty Alleviation, <sup>2n'</sup> Asian Ministerial Conference on DRR, New Delhi, India, 7-8 November, 2007. [www.nidm.gov.in/amcd\\_presentations/roupb\\_themel/gloor.pdf](http://www.nidm.gov.in/amcd_presentations/roupb_themel/gloor.pdf), accessed on 30.3.2008.

Government of Bangladesh (2008) *Cyclone Sidr in Bangladesh Damage, Loss, and Needs Assessment for Disaster Recovery and Reconstruction*, assisted by International Development Community with financial support from the European Commission, [gfdrr.org/docs/AssessmentReport\\_Cyclone%20Sidr\\_Bangladesh\\_2008.pdf](http://gfdrr.org/docs/AssessmentReport_Cyclone%20Sidr_Bangladesh_2008.pdf), accesses on 14.10.2008.

Hasan, D. M (1985) *A Study of Traditional House Forms in Rural Bangladesh*, partial fulfillment of the requirement for the degree of Masters of Architecture, Department of Architecture, **Bangladesh** University of Engineering and Technology, Dhaka, Bangladesh.

Independent Evaluation Group, The World Bank (2006) *Hazards of Nature, Risk to Development an IEG Evaluation of World Bank Assistance, for Natural Disasters*, The World Bank, Washington D.C, U.S.A, ISBN 10 0-8213-6650-5. [www.worldbank.org/ieg/naturaldisasters/report.html](http://www.worldbank.org/ieg/naturaldisasters/report.html), accessed on 2. 9. 2008.

**Intergovernmental Panel on Climate Change** (2000) *Summary for Policymakers Land Use, Land Use Change, and Forestry*, ISBN 92-9169-114-3

Kabir, K.H, and Mallick, F.H (2005) "Living Below the Line: Sustainability and the Houses of the Ultra Poor", Conference on Passive and Low Energy Architecture, **Beirut**, Lebanon, 13-16 November, 2005.

Mallick, F. H, Ahmed, K. I. Kabir, M. H, and Kabir, K. H (2007, unpublished) *Improved Design and Construction of Rural Housing in Noakhali, Bangladesh*, **International** Union for the Conservation of Nature, Dhaka, **Bangladesh**.

Mangrove Action Project (2008) removal of Myanmar's mangrove forest defenses gave cyclone easy ride into exposed delta, 9.5.2008, [http://www.mangroveactionproject.org/news/current\\_head\\_lines/removal-of-myanmars-mangrove-forest-defenses-gave-cyclone-easy-ride-into-exposed-delta](http://www.mangroveactionproject.org/news/current_head_lines/removal-of-myanmars-mangrove-forest-defenses-gave-cyclone-easy-ride-into-exposed-delta), accesses on 26.10.2008.

Map of Khuntakata Union, collected from Local Government Division (LGD), Ministry of LGRD and Cooperatives, Agargaon, Dhaka.

Map of tsunami, <http://tsun.sccc.ru/2004I226mod.htm>, accessed on 14.10.2008.

**Ministry of Food and Disaster Management (2008) *Super Cyclone SIDR 2007 Impacts and Strategies for Interventions*, Government of People's Republic of Bangladesh, Bangladesh Secretariat, Dhaka. [www.cdmp.org.bd/reports/Draft-Sidr-Report.pdf](http://www.cdmp.org.bd/reports/Draft-Sidr-Report.pdf); accessed on 30.3.2008.**

Ministry of Food and Disaster Management (2007) *Bangladesh Super Cyclone 'Sidr' 2007, the people's Republic of Bangladesh, updated on 12.12.2007, [www.lcgbani.ladash.org/derweb/cyclone/DOCS/Sidr.../2007-12-12 Bangladesh %20Super%20Cyclone%20'SIDR'%202007 MoF](http://www.lcgbani.ladash.org/derweb/cyclone/DOCS/Sidr.../2007-12-12%20Bangladesh%20Super%20Cyclone%20'SIDR'%202007%20MoF)*, accessed on 1.12.2008.

**Ministry of LGRD and Cooperatives, Evolution of Local Government in Bangladesh, Local Government Division, <http://www.lgd.gov.bd/lit ml/about.html>, accessed on 14.10.2008.**

National Information Center of Earthquake Engineering (2004) *Guidelines for Earthquake Resistant Non-Engineered Construction*, Indian Institute of Technology, Kanpur, India, revised edition of International Association of Earthquake Engineering (1980) *Basic Concepts of Seismic Codes, volume I part 2*, Tokyo, Japan.

**Padma, T. V, 2004, Mangrove forests `can reduce impact of tsunamis' <http://www.scidev.net/cnineews/mangrove-forests-can-reduce-impact-of-tsunamis.html>, accessed on 13.10.2008.**

Plans and Elevations of Cyclone Shelters by Brac, collected from Architecture Department, Brac University, Dhaka, Bangladesh.

**Rahman, M. A (2004) "Participatory Action Research Learning from the School of Life", keynote paper prepared for the international workshop on participatory action research organized by research initiatives, Bangladesh on Dhaka, March 27-31 2004.**

**Rahman, T (2008, unpublished)** *A Study of Cyclone Shelters in Bangladesh: A Case for Deconstruction and Decentralization*, partial fulfillment of the requirement for the degree of Masters in Disaster Management, Department of Architecture, BRAC University, Dhaka, Bangladesh.

**Reuters, (2008)** "Focus Sharpens on Forest on Climate Fix", <http://www.reutei-s.com/article/enviroronentNews/idUSTIZL-:4971311120081009?pageNumber=3&virtualBrandChannel=0> accessed on 10.10.2008.

**Seraj, S. M. and Ahmed, K. 1. (2004)** *Building Safer Houses in Rural Bangladesh*, Bangladesh University of Engineering and Technology, Dhaka, ISBN 984-32-1280-5

**Tasneem, S. and Chaudhury, M. (2007)** *Research Report Measuring the Impact of False Tsunami Warnings in Bangladesh*, Research and Evaluation Division, BRAC, Dhaka, Bangladesh.

**The Daily Star (2008) Staff Correspondent**, "Cyclone Nargis Poised to Strike in 4-5 Days Farmers Asked for Quick Boro Harvest", 29.4.2008.

**The Daily Star (2007) Staff Correspondent**, "Government Sanctions Tk 20 cr, 3000 Tonnes of Rice", 17.11.2007.

**TIME (2007) Robinson, S, "How Bangladesh Survived a Cyclone"**, 19.11.2007, <http://wxvw.tinie.coni/time/world/article/0.8599.I685330.00.litml>, accessed on 21.10.2008.

**UNESCO World Heritage Center (2007)** "Sundarbans World Heritage Site Devastated by Cyclone, According to UNESCO Experts who visited the Site", 7.12.2007, <http://whc.unesco.org/en/news/399>, accessed on 1.3.2008.

**Wikipedia, Cyclone Nargis**, [http://en.wikipedia.or^-./wiki/Cyclone\\_Nargis](http://en.wikipedia.or^-./wiki/Cyclone_Nargis), accessed on 16.11.2008.

## **APPENDICES**

### ***APPENDIX A***

#### *QUESTIONNAIRE FOR THE INHABITANTS*

1. How do they distribute spaces in a homestead and in the main house form?
2. How do they orient their houses in context of the weather and nature?
3. How do they decide on placement and numbers of doors and windows in a house?
4. How do they relate verandahs with the main house?
5. Why do they not consider courtyard centered homesteads like a typical rural space arrangement?
6. What do they consider positive and negative points about traditional houses in usability and hazard resilience context?
7. If money was not a problem what kind of house would they make for themselves?
8. How did their house get damaged in the recent disaster?
9. What kind of materials did they use in that house construction?
10. Where did they evacuate during the cyclone?
11. What kind of hazards do they face in the locality?
12. What would be feasible for them to take refuge and save their livestock, assets etc during the disaster?
13. What would be better for the overall planning improvement of the locality?

#### *QUESTIONNAIRE FOR THE LOCAL CRAFTSMEN*

1. Are there any traditional calculation/ measurement to follow in a house form?
2. Please give some views about the elements in a house like the plinth, walls, openings, roof etc. in a traditional house and materials used in it.
3. What construction techniques are used in the traditional houses in the locality?
4. What elements do you think would be the most suitable in durability and hazard resilience in the relief houses that are recently been distributed in the locality?
5. Do you think that the smaller size of the relief houses is better than the traditional larger size in hazard resilience and durability? Please express why.
6. Do you think that the use of brick, cement, CI sheet etc would gradually change the house pattern and fabric of the locality? How do you view it?

*QUESTIONNAIRE FOR THE NGO PERSONS WORKING IN THE FIELD (BRAC IN THIS RESEARCH)*

1. What have you observed as natural hazards of the region?
2. How do you help the locals cope with it?
3. What was the situation during the SIDR cyclone considering evacuation, rescue and relief activities in the locality?
4. What was the damage scenario here?
5. How did locals save themselves during this disaster? How did they save their assets?
6. How did you operate the relief and rehabilitation activities in the initial and later stages? What constrains did you face in it?
7. What are the programs taken by your NGO and other NGOs in the locality?
8. Do you think it would be better to integrate these programs with the normal develop activities of the locality?
9. What are the conditions of physical infrastructures in the locality for evacuation, rescue and relief distribution? How can these be improved?
10. Do you think NGOs should come forward in the physical development of localities like building and repairing roads, bridges, embankments etc? How can integration of NGOs in these activities help improve the quality of built environment?



APPENDIX B

●	<p>4oil Sr cvld ba c,rv he l "A grieved tl,rovgh a eoreex</p>
ti	<p>D'c4 r;s 94,d Orga+,iG m7ttcr 5lnovld be- rc-woo ve ^</p>
	<p>g;/ Cjeme+,t" {y volvl%e• ,hould l/d m;xeol with earth i,, dry statue.</p>
+20^1 t	<p>After rn;x;ng tlorou,Miy, water should bd added to m-7ke o pasta-r;k^ M; -A ture-.</p>
	<p><b>So;l-cement m;x {-o</b> ke, placed a.,d corwraeted by t,a.1c1. To act,; eye - ymooth <b>finigh, trOWel</b> C'w He- voed</p>
	<p>Af tew- co+nplgt;on of Ga5t;n9, { e f;n;shad plihth si/OJId<sup>-</sup> V<sub>im</sub>· compS&amp;Yasi w;tn a ln d- ra+nrner.</p>
	<p>Gvr;n9 5l,oulal be- olo&amp;le for 2-3 weeks by wettinj at freVent int erV 4 . Ca++ 64r- -Cove <b>red led jute- 52rk5</b> <b>t o key wet</b></p>

8: Procedures of plinth preparation (source: IJCN, 2007)

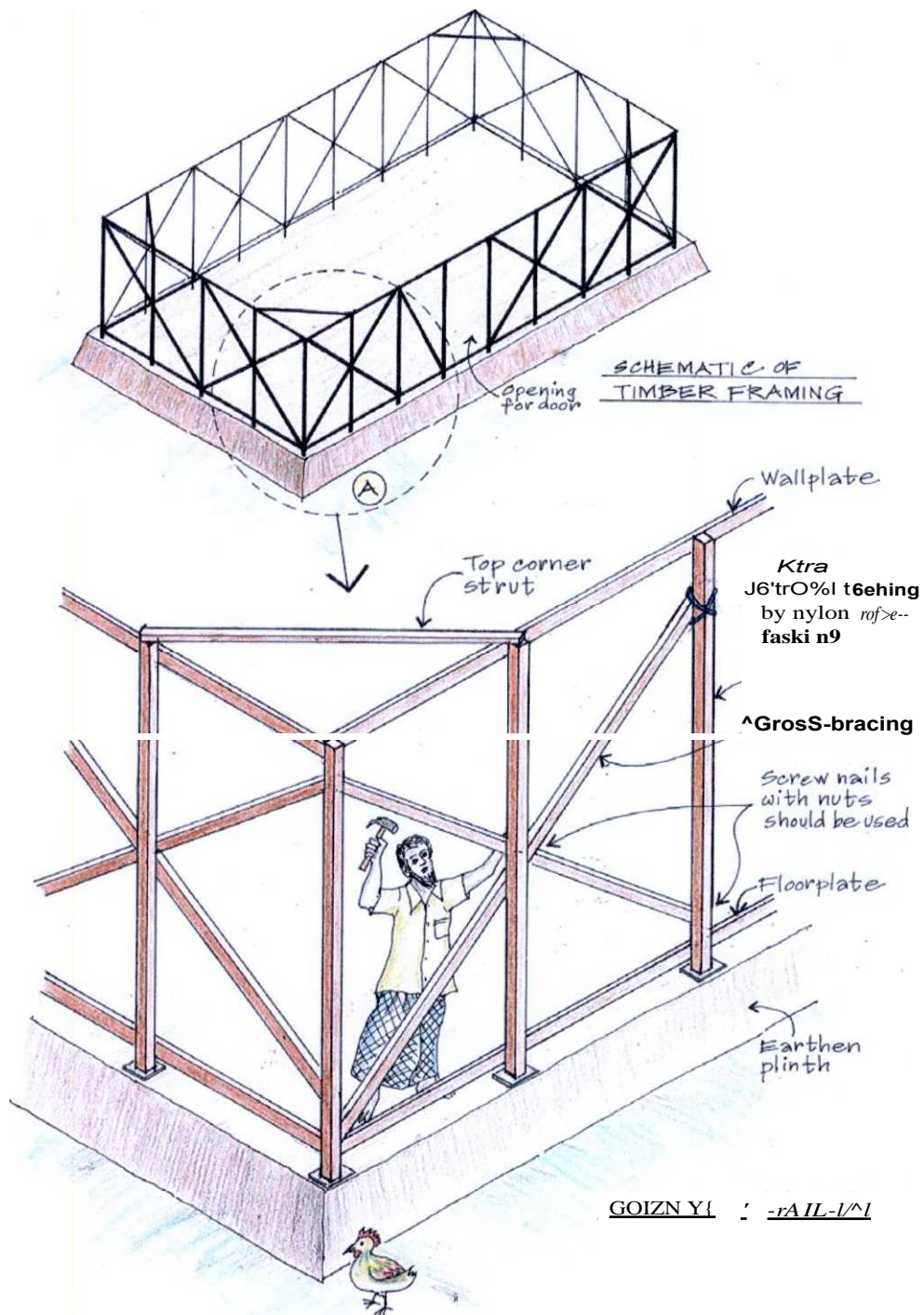

9: Cross bracings on the frames (source: IUCN, 2007)

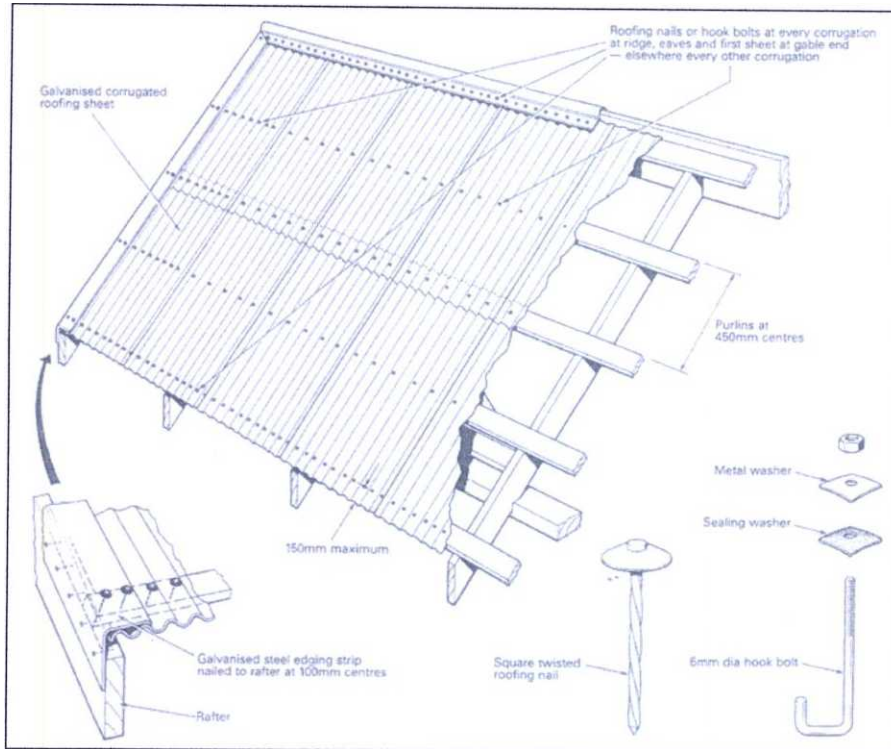

10: Properly nailed C I sheet roof (source: IUCN, 2007)

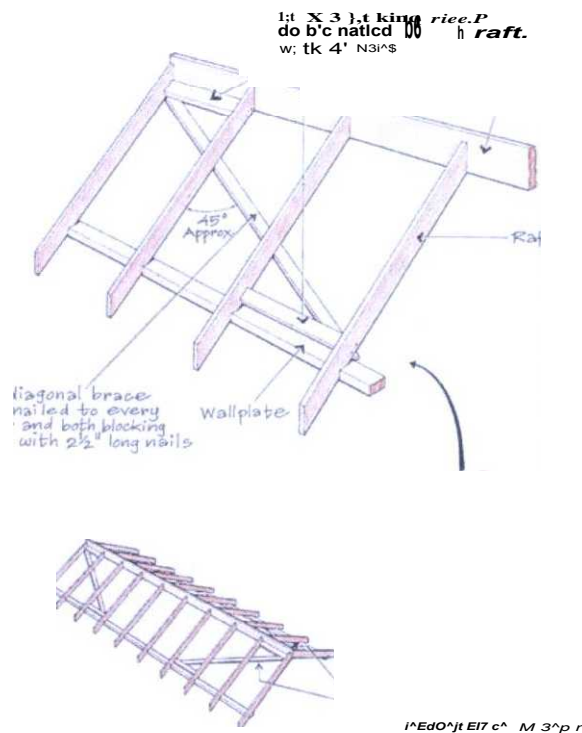

11: Bracings in roof frame (source: IUCN, 2007)

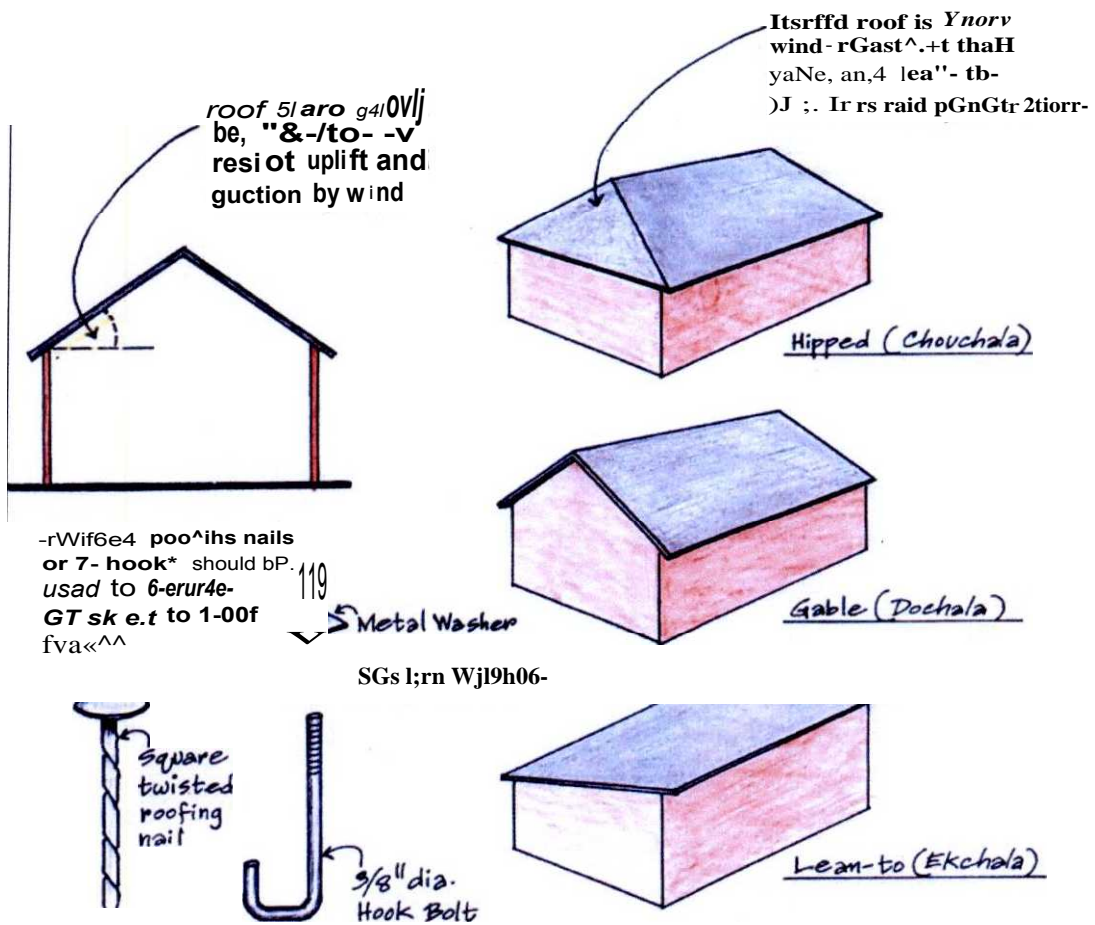

12: Appropriate roof slope and shapes considering wind load (source: IUCN, 2007)

## Glossary

*Bawali* - people engaged in collecting forest product from the Sundarbans.

*Beels* - large excavated water body created for collecting drinking water and fish cultivation.

*Chouchala* - hip roof.

*Dochala* - gable roof.

*Ekchala* - lean to roof.

*Golpata* - Nipa Palm. Leaf used for house construction.

*Haat* - village weekly market, open for two or three days a week.

*Hogla* - leaf used for house construction.

*Khasjami* - government land usually fallow.

*Kupi* -oil lamp.

*Kewra* - a mangrove tree; used for making scented water for cooking; locals eat its fruit.

*Kutcha* - unmetalled, not of permanent construction.

*Loha kath* - hard durable wood used for house construction.

*Namaaz* - daily prayers of Muslims.

NGO - Non Government Organization.

*Pata* - clay pottery like platform used to hold timber post on the plinth.

PSF - Pond Sand Filter, used for harvesting rain water.

*Pucca* - metalled, of permanent construction.

*Atchala* - hip roof surrounded at four sides by another layer of hip roof at the lower end.

*Bandho, bandhok* - a local technique used in measurements of rural house constructions.

*Macha* - platform.

*Union Parishad*- local government office/ authority at Union Level of a sub district.

*Union ParishadBhaban* - Union Parishad Office building.

Madrasa - schools run on Islamic educational curriculum.

Upazilla - sub division.

*Mehagani* - a kind of timber tree.

*Chambal* - a kind of timber tree.

*Babla* - a kind of timber tree.

*Shirish* - Rain tree, a kind of timber tree.

*Maitta* oil - petroleum kind of oil mixture used as varnish on leaf construction surfaces as insect repellent.

*Bolli* - lower end of timber post embedded inside the plinth, separate from the main post.

*Kaatla* - concrete stump embedded inside the plinth to support posts with clamp joints.

*Gorani* - protective lower panel of walls made of C I sheet, used as protection against rain.

*Bhelki* - protector over door and gable end of roof made of C I sheet, used as protection against rain.

*Thana* - police station.

*Pashchati* - separate pitch roof verandah surrounded around the house.

*Killa* - high ground used for cattle refuge during the time of cyclone.