

# **Functional Analysis of Depression Associated Proteins: Role of TRK, BDNF, CYP2B6, POLG, PICK1 Biomarkers for Early Detection and Treatment of Depression.**

A project submitted

by

Partha Sanjana Jurashe

ID: 14146015

Session: Spring 2014

to

The Department of Pharmacy

in partial fulfillment of the requirements for the degree of  
Bachelor of Pharmacy (Hons.)



Inspiring Excellence

Dhaka, Bangladesh

September, 2018

*Dedicated to my parents and my supervisor Mohammad Kawsar Sharif  
Siam Sir for endless support and appropriate guideline.*

## **Certification Statement**

This is to indorse that this project titled “Functional Analysis of iGluR DELTA 2 and other Depression Associated Proteins: Role of TRK, BDNF, CYP2B6, POLG, PICK1 for Early Detection and Treatment of Depression” acquiesced for the partial contentment of the requirements for the degree of Bachelor of Pharmacy (Hons.) from the Department of Pharmacy, BRAC University establishes my own exertion under the supervision of Mohammad Kawsar Sharif Siam, Senior Lecturer. MSc in Pharmacogenetics (UCL, UK) PhD Candidate (University of Cambridge, UK) Department of Pharmacy. BRAC University, Dhaka, Bangladesh and that appropriate credit is given where I have used the language, ideas or writings of another.

Signed,

---

Countersigned by the supervisor,

---

## **Acknowledgement**

Alhamdulillah, all the approbation belongs to Allah S.W.T. who is the source of our life, knowledge and the strength, encouragement, patience, gratefulness and assistance.

This research would not have been completed without some persons and here I would like to express my gratitude towards them.

It was such a pleasure and honor to work with the most dedicated & compassionate supervisor, Mohammad Kawsar Sharif Siam, Senior Lecturer. MSc in Pharmacogenetics (UCL, UK) PhD Candidate (University of Cambridge, UK) Department of Pharmacy, BRAC University, Dhaka, Bangladesh

I would also implore my appreciation to the Chairperson Dr. Eva Rahman Kabir, Department of Pharmacy, BRAC University and respectable faculty members.

Most essentially I am indebted to my family, my folks and my project partner Sazzad Zaman Ahmed who have braced me during this expedition and made the environment to work harder and complete this project.

## Abstract

Psychiatric diseases relentlessly distress the ability of work also productivity of a person's life. Considering the phenotypic unpredictability amongst patients, it is very hard to understand the pathogenesis. The study aims to identify the pathways responsible for psychiatric disease, especially for depression. Initially 62 depression associated proteins were listed from the UniProt and then hub genes of those proteins were identified. For functional annotation analysis, proteins UniProt IDs were submitted to the Database for Annotation, Visualization and Integrated Discovery shortly known as DAVID. Gene ontologies, protein domains, and pathways were analyzed using the GO enrichment and KEGG. The functional annotation clustering identified a total of 150 GO terms clustered into 23 groups. The pathways, identified from the clustering and KEGG, were overlapped to construct a Protein Protein Interaction (PPI) network. Finally, the common pathways were separated and 300 selected anti-depressants drugs from 5 classes were docked with depression associated proteins such as iGluR DELTA-2 (PDB ID- 5KC8), Dopamine Receptor, D2 (PDB ID- 6CM4), Sodium Dependent Serotonin Transporter (PDB ID- 2KS9), Glutamate receptor ionotropic, NMDA 2B (PDB ID- 5EWL) etc. Six anti-depressant drugs such as sertraline carbamoyl, norethindrone, and aripiprazole had good binding affinities (-10.5, -10.4 and -9.3 respectively) with the proteins of interest. The study also revealed that biomarkers like, TRK, BDNF, CYP2B6, POLG, PICK1 could be suitable for early detection of depression. Building on these findings, studies could be designed to target and examine protein clusters to understand depression and its transduction targets to identify functional biomarkers for early diagnosis.

## Contents:

Acknowledgement.....	i
Abstract .....	ii
List of contents.....	iii
List of tables.....	iv
List of figures.....	v
List of abbreviations .....	vi
1 Introduction .....	2
1.1 Depression .....	3
1.2 Classification, prevalence, and course of depression.....	4
1.3 Risk factors of depression.....	6
1.4 Literature Review .....	7
1.4.1 Biochemical root of deression.....	7
1.4.2 Synaptic transmission....	7
1.4.3 Endocrine process in depression.....	10
1.4.4 Structural changes in the depressed brain.....	11
1.4.5 Bioinformatics and depression.....	12
2 Methodology .....	15
2.1 Databases for the study.....	16
2.2 Software for the study.....	18
3 Results .....	19
3.1 Depression associated proteins were screened.....	20
3.2 Signaling pathways of associated proteins were identified by bioinformatics tool.....	21
3.3 PPI network construction and hub gene identification.....	25
3.4 Molecular docking with established anti-depressants drugs.....	28
4 Discussion .....	32
Conclusion .....	35
References .....	36

## List of Tables:

Table 1: Software used in this study .....	18
Table 2: List of screened proteins associated with depression .....	20
Table 3: Functional annotation clustering and GO function enrichment analysis .....	22
Table 4: The enriched KEGG pathway of depression .....	22
Table 5: Figures from constructed PPI network .....	25
Table 6: Hub genes associated with long-term depression.....	27
Table 7: Best docking results of proteins with established antidepressants .....	29

## List of Figures:

Figure 1: Diagram of synapse and schematically shown the steps of chemical transmission.....	07
Figure 2: The serotonin synapse.....	09
Figure 3: Structural and functional brain idiosyncrasies in patients with major depressive disorder	03
Figure 4: Application of bioinformatics tools in different areas of biological science.....	13
Figure 5: Assemble study and perception of network building for depression.....	16
Figure 6: Snapshot of biologic tools .....	17
Figure 7: KEGG pathway map (04730) for Long Term Depression.....	23
Figure 8: KEGG pathway map (04020) for Calcium Signaling Pathway.....	24
Figure 9: The constructed PPI network of depression.....	26
Figure 10: 2D structure of the established drugs .....	28
Figure 11: Structures of seven selected proteins for docking are given from RCSB PDB.....	30
Figure 12: Chronic anti-depressants pathways OF 5HT (SSRI).....	33



## **List of Abbreviations:**

- DSM =Diagnostic and Statistical Manual of Mental Disorders
- BDNF = Brain-derived neurotrophic factor
- cAMP = cyclic Adenosine Monophosphate
- 5HT = 5-hydroxytryptamine
- TRK = Tyrosine receptor kinase
- iGluR = Ionotropic glutamate receptor
- CYP2B6 = Cytochrome P450 2B6
- POLG = Progressive external ophthalmoplegia
- PICK1 = Protein Interacting with C Kinase-1

# **Chapter One**

## **Introduction**

## 1. Introduction

Apparently, we are more attentive on our physical health afore our mental health. Mental health is as essential as being physically fit. Psychiatric disorders are commonly considered as neuropsychological and neurobehavioral abrasions, and also unable to understand complicated information. Worldwide more than 450 million people suffer from mental disorder and 300 million people are affected by depression (World Health Organization 2010, 2016). Women are more affected by depression however males with this disability are more likely to have elevated risk of cancer (brain, colorectal cancer, corpus uteri, leukemia) (Sullivan, Hussain, Threlfall, & Bittles, 2004) The incidence of depression is quite high as 20% globally with a female to male ratio of about 5:2 (Weissman et al., 1996). Due to psychiatric diseases patient's lives are compromised and put huge economic pressure to the families.

It is difficult to investigate the etiopathogenesis of the diseases due to the phenotypic variability among the patients. At the present time, bioinformatics is an effective tool for the diagnosis and further identification of sensitive biomarkers and signaling pathways (Zhao et al., 2016).

Psychiatric illness is classified according to the Diagnostic and Statistical Manual of Mental Disorders, 4th edition (DSM IV). Those with the greatest impact on dentistry are:

- Anxiety disorders: Anxiety disorders are the most widespread mental health illnesses though they are less perceptible than depression, schizophrenia, and bipolar disorder. Thus this disorders can be assumed to account for reduced productivity, amplified morbidity and mortality proportions, and the progress of alcohol and drug exploitation in an enormous part of the inhabitants.
- Mood disorders: Mood disorders comprise bipolar disorder (both mania and depression), major depression and dysthymia. Inception of mood disorders usually occurs during adolescence. They have no single source but several issues, such as biochemical disproportion in the brain, socio-economic and physiological factors. Unintended factors also stimulus the correlation between physical conditions and depression. For instance, tendency for medications for chronic diseases.
- Somatoform disorders: This disorder is characterized by several, broad medical complaints have been defined since antiquity, when it was termed hysteria. To diagnose somatization

disorder according to DSM-IV, a pattern of pain complaints and GI (gastrointestinal), sexual and pseudo-neurologic symptoms is prerequisite.

- Schizophrenia and other psychotic disorders: Schizophrenia is a chronic, incapacitating psychotic disorder that affects 1% of adults. Symptoms of the disorder are exceedingly variable from individual to individual but then again characteristically contain “positive” symptoms (hallucinations, thought disorganization aberrations,), “negative” symptoms (social dysfunction, blunted affect, motivation deficiency), rational diminishing, and mood disruption. Schizophrenia incurs colossal, economic and subjective costs.
- Substance-related disorders: This DSM category comprises a protean set of clinical conditions, with the altered materials exerting different effects. Substance related disorders are, substance use disorders (dependence, use) and substance reduce disorders (intoxication, withdrawal, etc.)
- Eating disorders: Eating disorders are an imperative reason of physical and psychosocial indisposition in pubescent girls and young grownup women. They are less recurrent in men. The etiologies of eating disorders is composite and severely understood. There is a genetic inclination, and certain definite conservational risk factors have been implicated.

## **1.1 Depression**

A comprehensive range of mental health problems categorized by the negative effect, low mood and a range of associated emotional, cognitive, physical and behavioral symptoms is referred as depression (Abreu & Santos, 2008; Lewinsohn & Libet, 1972). To identify major depression not only the severity that matters but persistence is also vital.

Depression is basically seen by the mass people and majority media as a neuropsychiatric illness with a shifting way that is best labelled in disease-state terms for instance episodes, recovery, disorder, relapse, remission, recurrence, and relapse (Frank et al., 1991)

The psychopathological state involves symptoms with depressed mood, anhedonia, and less energy or weakness. Other signs, such as sleep and psychomotor disturbances, constant guilt, low self-esteem, suicidal trends, in addition to autonomic and gastrointestinal disturbances are often exist (Bondy, 2002).

## 1.2 Classification, prevalence, and course of depression

Depression is a composite phenomenon. The symptoms, etiology and occurrence are not specific, it differs from slight to severe symptoms with or without psychotic features and might interact between psychiatric and somatic diseases.

According to Diagnostic and Statistical Manual of Mental Health, Fourth Edition (DSM-IV) to diagnose appropriately, five out of the nine following DSM-IV symptoms must be present constantly for at least 2-week period (Bondy, 2002).

- (i) Depressed mood;
- (ii) Loss of interest or pleasure;
- (iii) Significant weight or appetite alteration;
- (iv) Insomnia or hyposomnia;
- (v) Psychomotor agitation or retardation;
- (vi) Fatigue or loss of energy;
- (vii) Feelings of worthlessness;
- (viii) Diminished ability to think or concentrate or indecisiveness;
- (ix) Suicidal ideation.

There have been many considerations on the origin and grouping on depression. At the beginning of 20<sup>th</sup> century there were two opposite perceptions,

- a) Emil Kraepelin's formulation of depression as a disease and
- b) Sigmund Freud's assessment of depression as an expression of suppressed rage and loss.

The recent publications of DSM-IV and the International Statistical Classification of Diseases, 10th Revision (ICD-10) (World Health Organization; 1992) distinguish unipolar (depression) from bipolar (manic depressive) disorder (Gurland, 1976; Katz, Secunda, Hirschfeld, & Koslow, 2015).

Few studies have shown that depression rises the risk of coronary artery disease, and deteriorates the prospects after myocardial infarction (Musselman, Evans, & Nemeroff, 2014).

Interestingly, it has high comorbidity rate with other psychiatric disorders. Anxiety, panic disorders are similarly associated with depression.

Depressive disorder comes in different forms, just as many other disorders. Seven of the most common types consist of the following (Iyer & Khan, 2012) .

- (i) Major Depressive Disorder (MDD): It is a mood disorder characterized by a number of important features, i.e. changes in weight, sleep variations, depressed mood, lack of interest in regular activities, difficulty concentrating, fatigue, low self-esteem, suicidal etc. Depression can be labelled as mild, moderate or severe (melancholic or psychotic).
- (ii) Persistent Depressive Disorder: Previously it was known as ‘dysthymia’; denotes to a type of chronic depression exist for long-term, that do not inactivate, however it doesn’t aid at feeling good. This type can be mild, moderate or severe.
- (iii) Bipolar Disorder: It is not closely as widespread as other forms of depressive disorders. Characterized by phases of unusually elevated mood identified as mania. These periods of mania can be mild (hypomania) or they can be so life. A range of physical and emotional signs which may comprise:
  - Insomnia, fatigue and lethargy
  - Inexplicable aches, and psychomotor distress
  - Hopelessness and low self-esteem
  - Irritability and nervousness
  - Hesitancy and inefficiency
- (iv) Premenstrual Dysphoric Disorder (PMDD): Produces similar symptoms as premenstrual syndrome (PMS), e.g. fatigue, moodiness, irritability, anxiety, increased appetite, bloating, aches, food cravings, and breast tenderness.
- (v) Postpartum Depression: Pregnancy can carry significant hormonal adaptations that can often distress a woman's temperaments. Depression can devour its commencement during pregnancy or after the birth of a child. It can sort from untiring lethargy and sadness that necessitates medical usage all up to postpartum psychosis. Psychosis is the mood which is convoyed by delusions, hallucinations and confusion.
- (vi) Seasonal Affective Disorder (SAD): It is presently called major depressive disorder, having recurrent pattern. Triggered by a disruption in the usual circadian phase of the body.

Light inflowing through the eyes effects this rhythm, and any regular variation in night/day array can cause an interference leading to depression.

(vii) Atypical Depression: A type of depression that does not track what was supposed to be the "typical" appearance of the condition. It is characterized by a specific set of signs listed below,

- Excessive eating or weight gain
- Excessive sleep
- Fatigue, weakness, and feeling "weighed down"
- Intense sensitivity to rejection
- Strongly reactive moods

### **1.3 Risk factors for depression**

- The influence of life occasions:

Life events forgoing depression are capricious and are possibly unrelated to the sign pattern, meaning that there is no alterations in the existence of occasions aggravating the commencement of non-endogenous or endogenous depression (Brown, Harris, & Hepworth, 1994). There is constant discussion on the control of trials on depressive upshot, as positive events were conveyed to progress outcome, though stressful occasions were displayed to lower improvement and upsurge the prospect of deterioration (Paykel, Cooper, Ramana, & Hayhurst, 1996).

- Genetic influences:

Evidence for genetic influence for bipolar disorder is very strong and estimated as 80% (Berrettini, 2001). Genetic mechanism which mainly focus on the interaction of different genes are not sufficient enough to know about the etiology leading to disease. As a result of complications in determining the clinical phenotype, further issues arises regarding the diagnosis. To understand pathophysiological mechanism further, molecular genetic studies offer to recognize the genes accountable for hereditary (Craddock, Khodel, Van Eerdewegh, & Reich, 1995).

## 1.4 Literature review

### 1.4.1 Biochemical root of depression

The significance of neuroscience is undeniable particularly in the field of biological investigations starting molecular studies of cell and gene functions to brain-imaging technologies (Kandel & Squire, 2000). Julius Axelrod, Arvid Carlsson, and few other Nobel Prize winners has helped us to understand the function of brain and whereas research on psychiatric diseases are done solely based in basic neuroscience (Bondy, 2002).

### 1.4.2 Synaptic transmission

The required steps for chemical transmission are, neurotransmitter synthesis, storage of neurotransmitter in the vesicles, release into synaptic cleft as well as transmission of the action and initiation of the cellular process leading to signal transduction cascade.

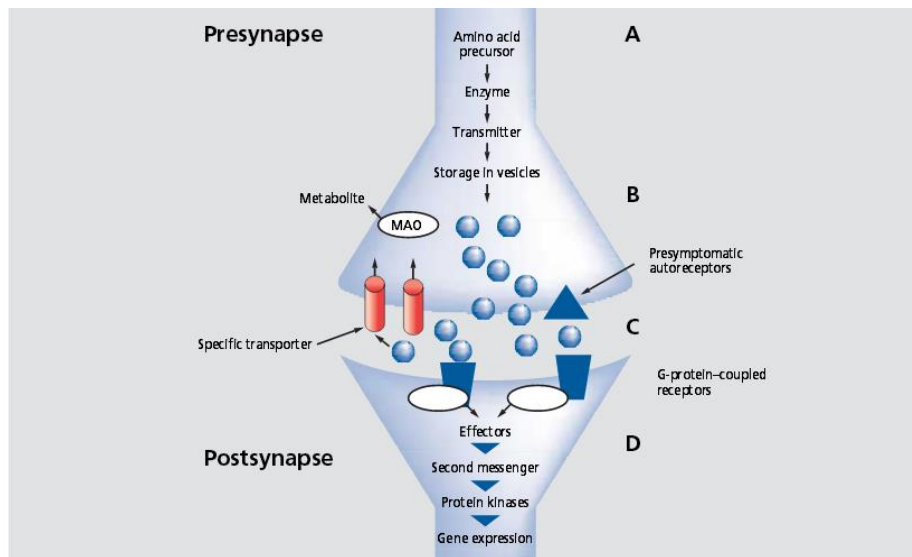

Figure1: Diagram of synapse and schematically shown the steps of chemical transmission. Amino acid precursors are being transported into brain via blood (A) precursor converted into transmitter through enzymatic procedure and stored (B) released into synaptic cleft (C) they can react with presynaptic or post synaptic auto receptors and regulate synthesis and release or induce signal transduction cascade (E) MAO = Monoamine Oxidase (Kuhar, Roth, & Aghajanian, 1972).



Neurotransmitter molecules induce a series of reactions by their initial binding to the receptors on the surface of the postsynaptic membrane; which are frequently combined to G proteins (guanine nucleotide binding proteins). These G proteins control several effector systems such as phospholipases, adenylylcyclases and the phosphoinositide mediated system inside the cells and thus symbolize crucial regulatory components in transmembrane signaling (R. S. Duman, Heninger, & Nestler, 1997). This events of signal transduction force for instance, intracellular  $\text{Ca}^{2+}$  ions concentration increase or secondary messengers (cAMP) cause phosphorylation of protein kinase. This initiate a pathway which regulates many biological response and control brain functions via neuronal ion channel regulation, release of neurotransmitter, receptor modulation and eventually synaptic potentiation and neuronal endurance (Battaini, 2001; Popoli, Brunello, Perez, & Racagni, 2000). In the process of chemical transmission, if any function in any steps are disrupted; it seems an essential mechanism causing depression. However, these mechanisms are now established as targets for antidepressants action.

- Monoamine hypothesis: About 30 years ago, a hypothesis was proposed mentioning the main symptom of depression and that is lack of functioning brain monoaminergic norepinephrine (NE), 5-HT, and/or dopamine (Coppen, 1967; Matussek, 1972; Schildkraut, 1965). This particular hypothesis has been developed from the animal experiments and clinical observations; reserpine is an anti-depressants drug that causes diminution of norepinephrine, 5-HT, dopamine in the presynaptic store. However, few patients being treated with iproniazid, gave effects of euphoria and hyperactivity that increases the concentration of above neurotransmitters. Considering the origin of neurons and its projections into many zones of the brain, monoaminergic systems are responsible for the symptoms of abnormal behaviors; such as mood disorder, vigilance, fatigue, psychomotor nervousness or retardation. Alteration in the synthesis, storage or release in the neurotransmitters along with the distribution of the receptors or subcellular messenger tasks may be the reasons for behavioral consequences of depression (Stahl, 1998).
- a) Neurotransmitter concentration: By measuring neurotransmitters and their metabolites in the brain tissue, body fluids (CSF, blood, urine), it was found that the metabolite  $\alpha$ -methoxy-4-hydroxyphenylglycol (MHPG) of NE showed decreased level in the brain signifying turnover of NE; thus supporting the hypothesis of lacking noradrenergic

system (Potter et al., 1985). However, the data results were inconsistent (Salomon, Miller, Krystal, Heninger, & Charney, 1997).

Likewise, the outcomes also suggested that reduced 5-HT function may not exist in every depressed patient. The data from the experiment shows a minor importance of transmitter synthesis. So, no conclusive abnormalities were found in MAO activity degradation (Leonard, 2000). Amusingly, lessening of monoamines did not prompt or worsen the symptoms of depression in unmediated patients, meaning that monoamine deficiency only is not adequate for the clinical syndrome. Conversely, in patients getting drug treatment, the response of antidepressants is dependent on the class of antidepressants (Lesch, Wolozin, Murphy, & Reiderer, 1993). That result signifies that pathophysiology of depression may not be only enlightened by a solitary monoamine associated mechanism, however it involves an intact monoamine scheme for therapeutic action (Owens & Nemeroff, 1994).

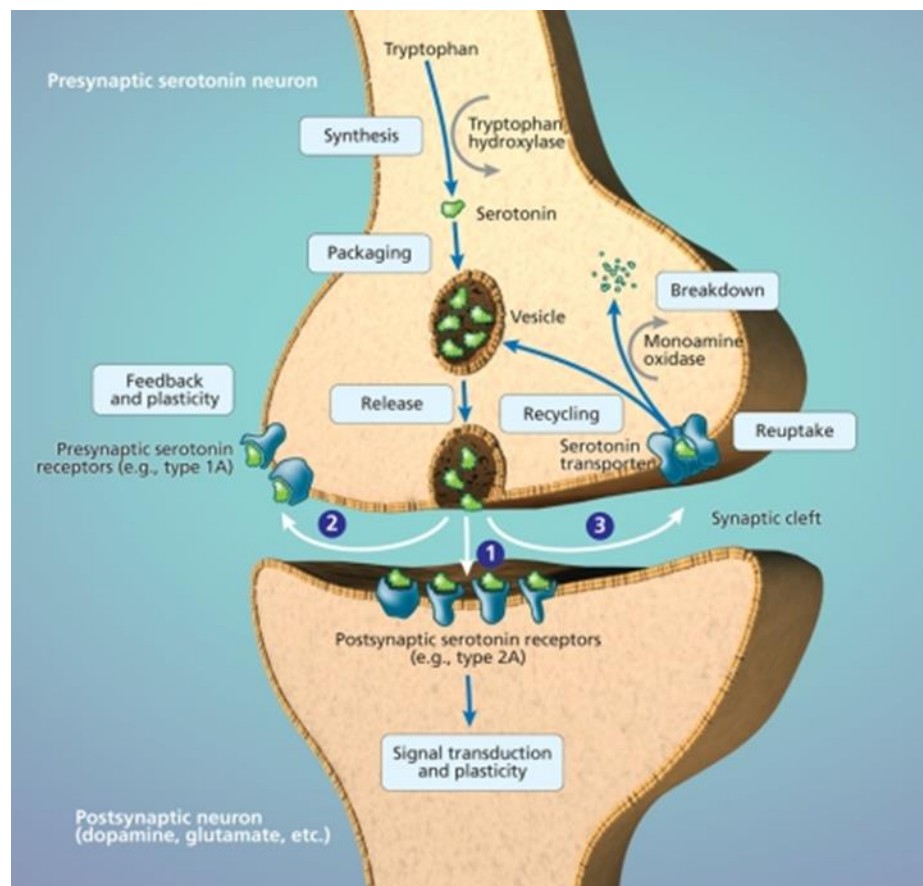

Figure 2: The serotonin synapse. Serotonin with the help of enzyme tryptophan hydroxylase; is synthesized from tryptophan, then packaged into vesicles and released from the synaptic cleft. This release cause multiple actions. (i) the serotonin neurons are stimulated after activation of postsynaptic receptors where serotonin binds. (ii) serotonin also binds to presynaptic receptors which further provide feedback and controls plasticity of the neuron. (iii) serotonin transporter cause reuptake of serotonin into the pre synaptic serotonin neurons. Furthermore, it is recycled for later or broken down into monoamine oxidase and excreted in the urine. Photo by: Lianne Friesen and Nicholas Woolridge (Rot, Mathew, & Charney, 2009)

- b) Transporters for neurotransmitter reuptake: In monoaminergic transmission, the transport proteins decrease the convenience of neurotransmitters in the synaptic cleft hence terminate the possessions of neurotransmitters on pre and postsynaptic receptors (Van der Does, 2001). Few studies have been conducted to measure the reuptake of NE. However, the postmortem samples gave controversial results signifying no liaison to genetic deviations of NE transporters (Hadley et al., 1995; Klimek et al., 1997).
- c) Neurotransmitter receptors: The findings from studies in peripheral cell prototypical system and/or finding G-proteins alterations at multiple sites of cAMP and on protein kinase in postmortem report of brain tissue (Coull, Lowther, Katona, & Horton, 2000; Ronald S. Duman, Malberg, & Thome, 1999; Perry, n.d.; Yatham, Srisurapanont, Zis, & Kusumakar, 1997). All these outcomes have led to molecular and cellular hypothesis of depression stating the position of signal transduction pathway is pivotal and also affect the balance of numerous neurotransmitter system and physiological processes.

### **1.4.3 Endocrine process in depression**

Noradrenergic stimulation responding to hormones, provided useful information about the potential role of NE and adrenal hormone and pituitary secretion in depression. The measurement of the responses directly or indirectly control noradrenergic activity. Growth Hormone (GH) release is encouraged by catecholamine mechanisms. Recurrent major depression Patients exhibit

blunted GH response which inferred as either decreased DA receptor or  $\alpha_2$ -adrenoceptor sensitivity (Bondy, 2002).

#### 1.4.4 Structural changes in the depressed brain

Depression patients presenting clinical signs of diminution may present with obstinate neurobiological abnormalities. These abnormalities may deteriorate over time, and some may develop chronically depressed. structural neuroimaging studies indicate that individuals with persistent major depressive occurrences may have comparatively insignificant hippocampi even throughout phases of clinical diminution. This also clarifies the memory glitches of some individuals as well as other symptoms of the disorder. Patients might show volumetric abnormalities in other brain regions, such as in subcortical regions includes ventral striatum and amygdala and in cortical regions include orbitofrontal, cingulate and prefrontal cortex (Hajek, Kozeny, Kopecek, Alda, & Höschl, 2008; Konarski et al., 2008).

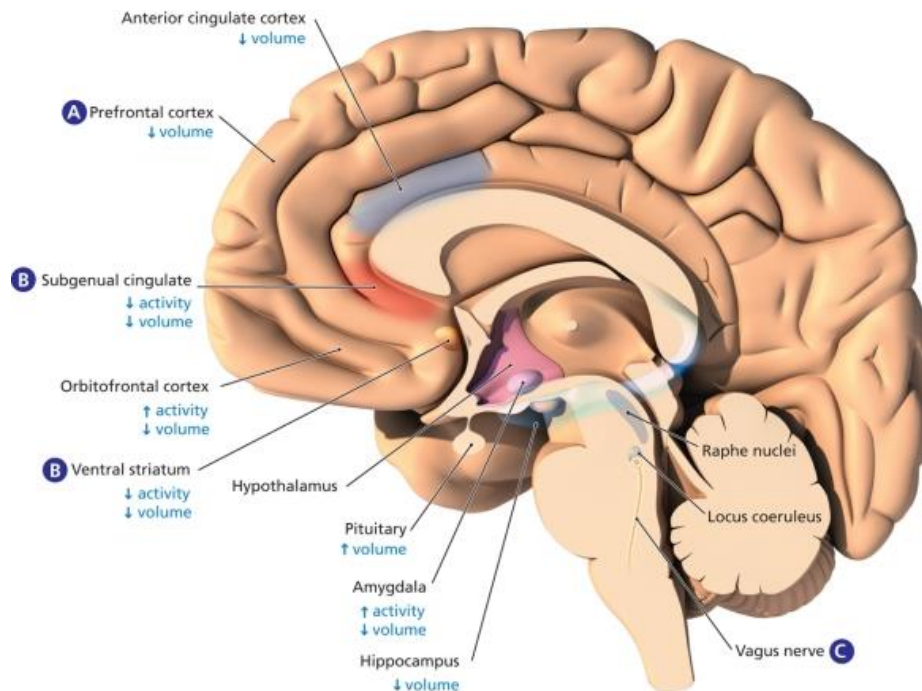

Figure 3: Structural and functional brain idiosyncrasies in patients with major depressive disorder, and the site of action of neurostimulation techniques with antidepressant potential. The anterior cingulate cortex specially subgenual cingulate show volume reduction. Other sub region parts as

prefrontal and orbitofrontal cortex also show the same. In the subcortical region, as in amygdala, hippocampus and ventral striatum; the volume is also decreased. Site of actions are, (A) Transcranial magnetic stimulation (B) Deep-brain stimulation (C) Vagus nerve stimulation. Image by: Lianne Friesen and Nicholas Woolridge (Rot et al., 2009)

Below the site of action of new neurostimulation techniques with antidepressants potential are listed from figure 3,

- A. Transcranial magnetic stimulation of prefrontal cortex
- B. Deep-brain stimulation of subgenual cingulate
- C. Vagus nerve stimulation have effects on locus coeruleus (a zone in the brain stem from which NE originates) that might show slight antidepressants activity.

Changes in metabolic activity is linked to structural brain abnormalities in depression patients. These are directly proportional to the severity of the diseases (Hasler, Drevets, Manji, & Charney, 2004).

### **1.4.5 Bioinformatics and depression**

The pathophysiology of depression is an exceptional experiment. Not only the symptoms are unrelated but also the etiologies diverse. The symptoms and clinical data provide perception into the neurobiology of depression. This molecular, behavioral and electrophysiological techniques divulge certain sides of depression cause from stress prompted neuroplastic changes in certain neural circuits (Krishnan & Nestler, 2008).

With the encroachment of bioinformatics tools, it is easier to get further insights into the pathophysiology of depression. Bioinformatics is a combination of various subject which has further developed methods for storage, retrieval and analyses of biological data. To process biological data more rapidly, it has become an indispensable part of biological science with databases and informatics (Aamer Mehmood, Sehar, & Ahmad, 2014). Computational tools are usually used for gene characterization, identification of proteins' structural and physicochemical properties, phylogenetic studies, and carrying out simulation study interaction of biomolecules in a living cell. Moreover, the in silico analyses can assist to reach a well-versed decision for conducting expensive experiments (Dibyajyoti, Talha Bin, & Swati, 2013).

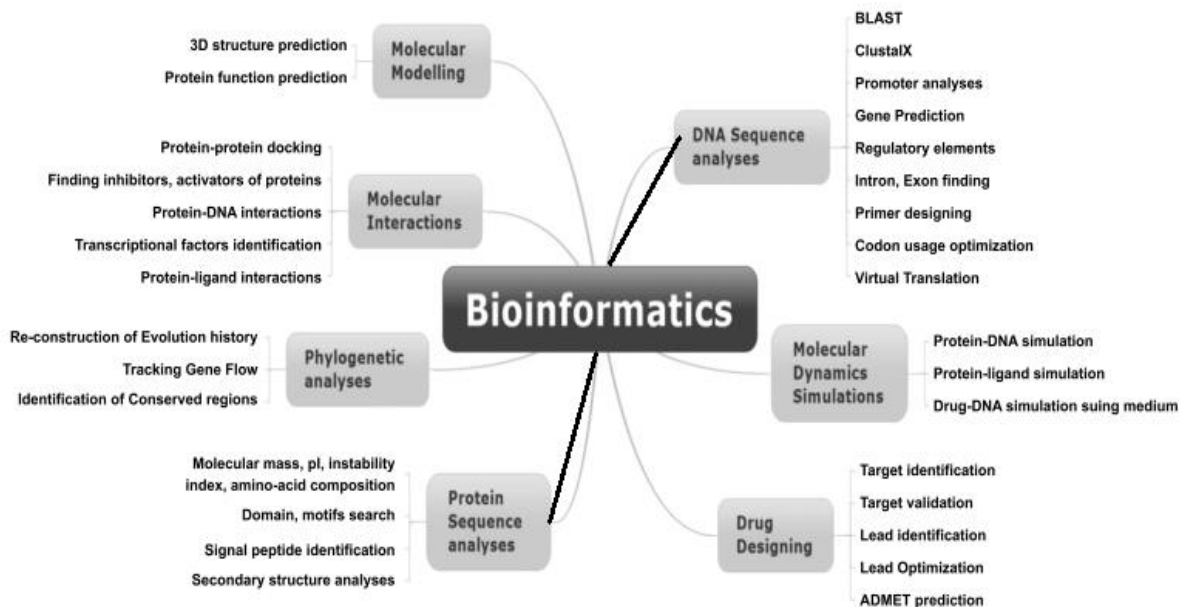

Figure 4: Application of bioinformatics tools in different areas of biological science (Aamer Mehmood et al., 2014)

Proteins hardly carry out their function in isolation, and consequently interact with other molecules all the time to complete a certain process. Experimental or bioinformatics approaches have become one of the most followed research area. These approaches aids in understanding how biomolecules interrelate with other molecules, e.g. drug design, protein folding and purification techniques (Wang, Huang, Yang, & Yang, 2010). Also essential to explicate the biological roles of a molecule by understanding molecular interactions, for instance, PPI (protein-protein interactions) is important in cellular activities, e.g. homeostasis, cellular metabolism, signaling transportation, and various biochemical processes (Vinayagam et al., 2014).

# **Chapter Two**

## **Methodology**

## 2. Methods

This paper was designed to understand the fundamental concepts and computational tools in bioinformatics and their application in psychotic disorder, i.e. depression. The bioinformatics approaches on depression were extensively studied to understand the underlying mechanisms of action followed by searching several databases (subsection 2.1). Initially, all the proteins associated with depression were listed (table 3) and screened in DAVID (The Database for Annotation, Visualization and Integrated Discovery). From DAVID, Functional Annotation Clustering was performed and GO term enrichment was analyzed; their pathways and mechanism were generated using KEGG (Kyoto Encyclopedia of Genes and Genomes)(Chen et al., 2015). The pathways and mechanisms are required to define category of drug molecules based on their targets.

In order to detect depression at early stage biomarkers are significant. In this study, biomarkers are acknowledged through hub genes identification. To determine the hub genes, PPI network was constructed (figure 5). Number of nodes in the network signifies number of proteins; and their interaction with another protein within the same network.

Furthermore, from five classes of anti-depressants, randomly 300 drugs were selected to dock with proteins that match the targets of the KEGG pathways and the best results were shown in table 7. The proteins were visualized and curated in PyMOL and the drugs were downloaded as SDF (Structure Data File); ultimately docked using PyRx. The binding affinity of the drugs with target proteins indicates better therapeutic value of the drugs.

A flow chart is given bellow to explain the methodology concisely.



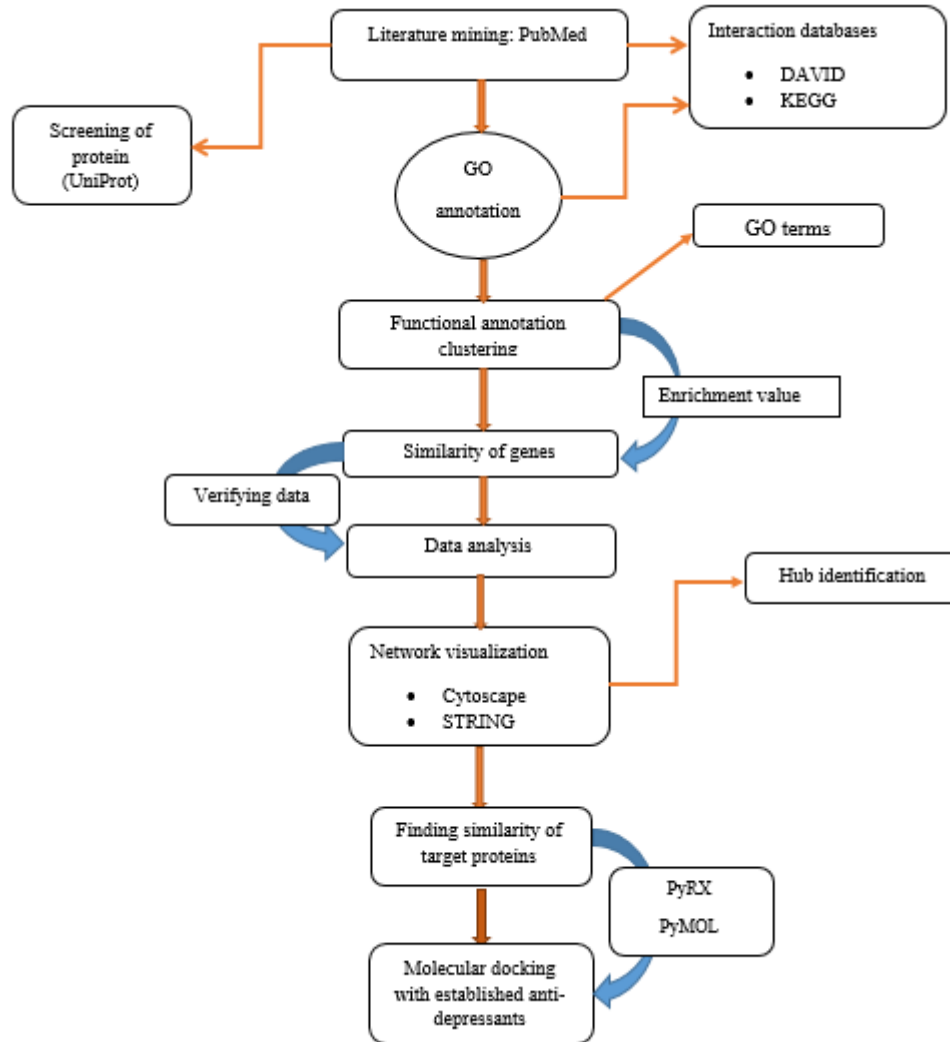

Figure 5. Assemble study and perception of network building for depression

## 2.1 Databases for the study

Using the bioinformatics databases, the comparison of the proteins was done exclusively.

- (1) The UniProt (Release 2011\_10, <http://www.uniprot.org>) was used to screen depression associated proteins. All human proteins were extracted. Then the linked proteins were additionally filtrated manually from the downloaded data (Doğan et al., 2016).

(2) Protein IDs were submitted to DAVID (<http://david.abcc.ncifcrf.gov/>), for functional analysis, for example GO terms, pathways and protein domains. The GO groups includes biological process (BP), molecular function (MF), and cellular component (CC). GO terms were well-thought-out significance with P value <0.01, and KEGG pathways with <0.05.

(3) STRING database is a search tool to evaluate protein–protein interactions data. The protein networks were statistics and the important nodes are known as hub genes (von Mering et al., 2003).

(4) esyN (<http://www.esyn.org/>) is a network tool that permits the building of two separate sorts of networks, Graphs and Petri nets. In this study, graphs network was used to signify the nodes and edges of the protein-protein interaction.

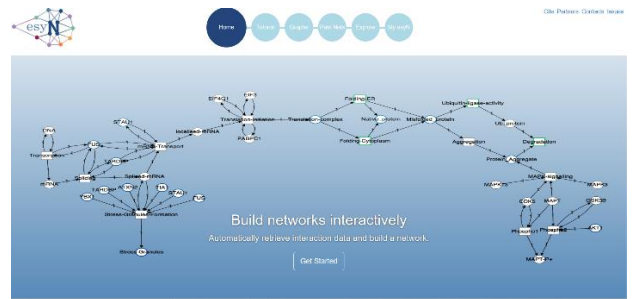
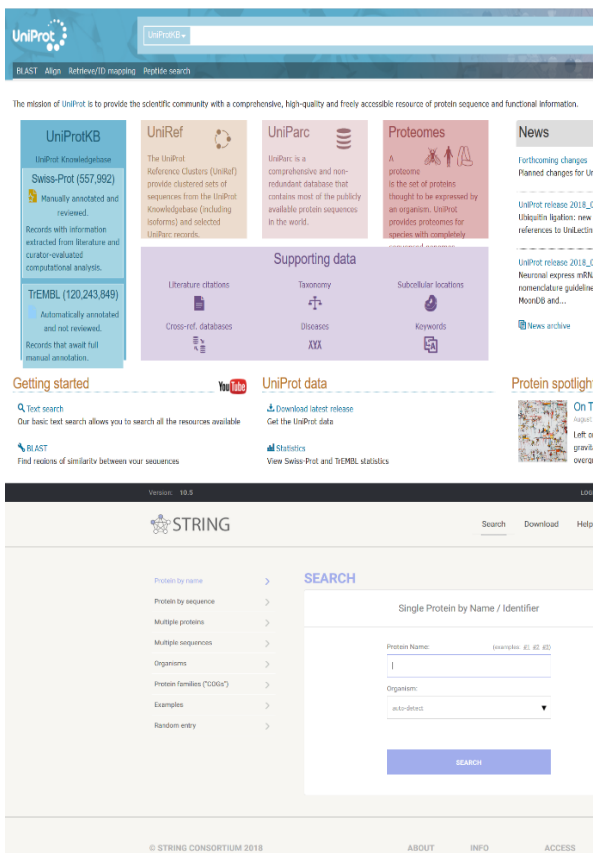

Figure 6. Snapshot of biologic tools.

## 2.2 Software for the study

To accomplish the binding affinity from molecular docking many software are required.

From visualizing the proteins to check for the alignment, software listed below (table 2) were used in this study,

<i>Software used</i>	<i>Versions</i>	<i>References</i>
<i>PyRX</i>	0.8	(Dallakyan & Olson, 2015)
<i>PyMOL</i>	2.0.4	(DeLano, 2002)
<i>Swiss PDB Viewer</i>	4.1	(Guex & Peitsch, 1997)
<i>MEGA 6</i>	6.06	(Tamura, K., Stecher, G., Peterson, D., Filipski, A. and Kumar, 2013)
<i>Open Babel</i>	2.4.1	(O'Boyle et al., 2011)
<i>Cluster Omega</i>	1.2.4	(Robinson, Mistry, Mcwilliam, Lopez, & Marsh, 2009)

Table 1. Software used in this study

# **Chapter Three**

## **Results**

### 3.1 Depression associated proteins were screened

From the UniProt (Release 2011\_10, <http://www.uniprot.org>) database we have screened and collected 62 human proteins associated with depression (table 2).

(1) Glutamate receptor ionotropic, delta-2	(32)Coiled-coil and C2 domain-containing protein 1A
(2)Cerebellin-1	(33)Cannabinoid receptor 2
(3)Dynactin subunit 1	(34)Cytochrome P450 2B6
(4)PRKCA-binding protein	(35)5-hydroxytryptamine receptor 3A
(5)Sodium-dependent serotonin transporter	(36)5-hydroxytryptamine receptor 3B
(6)Tryptophan 5-hydroxylase 2	(37)ADP translocase 1
(7)ADP-ribosylation factor 1	(38)Muscarinic acetylcholine receptor M2
(8)Sarcoplasmic reticulum calcium ATPase 2	(39)Sodium/potassium/calcium exchanger 1
(9)Serine protein kinase PLK2	(40)Sodium/potassium/calcium exchanger 2
(10)SH3 and multiple ankyrin repeat domains protein 3	(41)Progressive external ophthalmoplegia 1 protein
(11)Neurabin-1	(42)PDZ and LIM domain protein 5
(12)Ribonucleoside-diphosphate reductase subunit M2 B	(43)Leukocyte immunoglobulin-like receptor subfamily B member 2
(13)SH3 and multiple ankyrin repeat domains protein 2	(44)Phosphatidylinositol 3,4,5-trisphosphate 3-phosphatase and dual-specificity protein phosphatase PTEN
(14)Serum response factor	(45)Leucine-rich repeat-containing protein 7
(15)Syntaxin-binding protein 1	(46)Glutamate receptor ionotropic, NMDA 2B
(16)SH3 and multiple ankyrin repeat domains protein 3	(47)Phosphatidylinositol 3-kinase regulatory subunit alpha
(17)Potassium voltage-gated channel subfamily B member 1	(48) Paired box protein Pax-6
(18)Brain-derived neurotrophic factor	(49)Adenosine receptor A1
(19)Glycine N-acyltransferase	(50)CDGSH iron-sulfur domain-containing protein 2
(20)Metabotropic glutamate receptor 1	(51)Wolframin
(21) Glutamate receptor 1	(52)Transient receptor potential cation channel subfamily V member 1

(22)Synaptic functional regulator FMR1	(53)Tax-responsive element-binding protein 5
(23)Protein-tyrosine kinase 2-beta	(54)Advanced glycosylation end product-specific receptor
(24)DB dopamine receptor	(55)Monoacylglycerol lipase ABHD6
(25)Diacylglycerol kinase iota	(56)Glycine N-acyltransferase-like protein 2
(26)DNA polymerase subunit gamma-2, mitochondrial	(57)Phosphatase and tensin-like protein
(27)D1dopamine receptor	(58)Serum response factor
(28)Dendritic cell nuclear protein 1	(59)Complexin-2
(29)DNA (cytosine-5)-methyltransferase 1	(60)ADP-ribosylation factor 1
(30)DNA polymerase subunit gamma-1	(61)Glycine N-acyltransferase-like protein 1
(31)ADP-ribosyl cyclic ADP-ribose hydrolase 1	(62)Putative sodium-coupled neutral amino acid transporter 8

Table 2. List of screened proteins associated with depression.

### 3.2 Signaling pathways of associated proteins were identified by bioinformatics analysis

For functional analysis, protein IDs were submitted to The Database for Annotation, Visualization and Integrated Discovery (DAVID) (<http://david.abcc.ncifcrf.gov/>). Gene ontologies, protein domains, and pathways were also found. Since we only worked with depression, after the functional annotation clustering there were a total of 150 GO terms clustered into 23 groups if the stringency is medium. If the stringency is medium we get 13 clusters. Consequently, higher the stringency, more enriched values. The enrichment analysis of GO categories consists of biological process (BP), molecular function (MF), and cellular component (CC).

These terms were considered to be significant with P value less than 0.01 besides P value was calculated by right-sided hyper geometric tests. And the top 5 pathways significantly involved in GO terms were, long term synaptic depression, protein binding, postsynaptic membrane, glycine N-acyltransferase activity and neurotransmitter receptor activity.

<b>Description</b>	<b>Enrichment value</b>	<b>Count</b>	<b>P value</b>
Membrane	2.98	45	3.3E-8
Plasma membrane	2.98	32	2.1E-6
Transmembrane helix	2.98	31	3.4E-4
Cell membrane	15.47	28	1.2E-7
Transmembrane region	2.98	27	2.9E-3
Glycoprotein	2.98	26	9.4E-4
Integral component of membrane	2.98	25	5.0E-2
Topological domain: Cytoplasmic	2.98	23	4.2E-4
Glycosylation site: N-linked (GlcNAc...)	2.98	22	1.3E-2
Postsynaptic membrane	15.47	21	4.4E-24

Table 3 Functional annotation clustering and GO function enrichment analysis.

Here the GO description terms validate the predetermined clusters of genes. The count number here represents the enrichment value of genes that validate stringency. Stringency signifies the tight binding and exact number of cluster and number of genes in the cluster. Low stringency causes mismatch between the nucleic acids.

<b>Term</b>	<b>Description</b>	<b>Count</b>	<b>P value</b>
KEGG:04080	Neuroactive-ligand-receptor interaction	10	5.8E-5
KEGG:04020	Calcium signaling pathway	8	1.4E-4
KEGG:04024	cAMP signaling pathway	8	2.6E-4
KEGG:04724	Glutamatergic synapse	6	8.1E-4
KEGG:05030	Cocaine addiction	4	3.9E-3
KEGG:05031	Amphetamine addiction	4	8.9E-3
KEGG:04022	cGMP-PKG signaling pathway	5	2.2E-2
KEGG:04726	Serotonergic synapse	4	3.5E-2
KEGG:05016	Huntington's disease	5	3.5E-2
KEGG:04728	Dopaminergic synapse	4	5.0E-2
KEGG:04068	FoxO signaling pathway	4	5.6E-2
KEGG:04730	Long-term depression	3	5.8E-2
KEGG:04720	Long-term potentiation	3	6.8E-2

Table 4. The enriched KEGG pathway of depression. Term= Enriched term associated with gene list; Count= Genes involved in the term; P value= the smaller the more enriched

Most of the proteins can be categorized into various functional clusters and thus they participate in different biological actions of brain. Ontological analysis as functional clustering analysis implies that those proteins were pointedly related to specific five GO terms, among them transmission of nerve impulse is more enriched with depression.

Thirteen Significant KEGG pathways with a P value less than 0.05 associated with long term depression were listed in Table 4.

Neuroactive ligand receptor has count number 10 meaning 10 genes are involved in this term and it is enriched predominately by HRAS (Harvey rat sarcoma viral oncogene homolog), which participates in 18 significant pathways and plays a role as psychiatric disease marker (Schwartz et al., 2013). This ligand-receptor interaction also leads to mTOR pathway which is a serine-threonine kinase enzyme and underlying intracellular pathways (Kabir, Siam, Kabir, Khan, & Rajib, 2017) .

Significant KEGG pathways for Calcium signaling pathway (KEGG: 04020) and Long-term depression (KEGG: 04730) are shown.

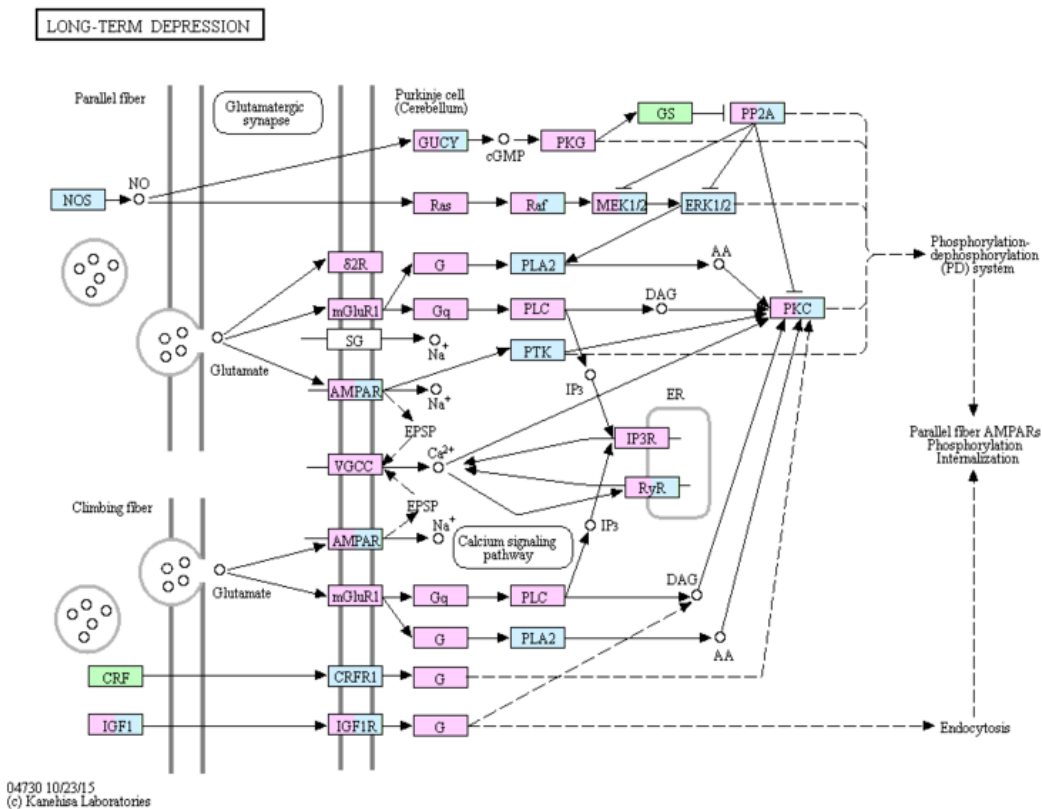



Figure 7. KEGG pathway map (04730) for Long Term Depression. This process comprises in decreasing synaptic strength amongst parallel fiber (PF) and Purkinje cells (PCs). Multiple signal transduction pathways are involved in this process (M Kanehisa & Goto, 2000; Minoru Kanehisa, Furumichi, Tanabe, Sato, & Morishima, 2017; Minoru Kanehisa, Sato, Kawashima, Furumichi, & Tanabe, 2016)

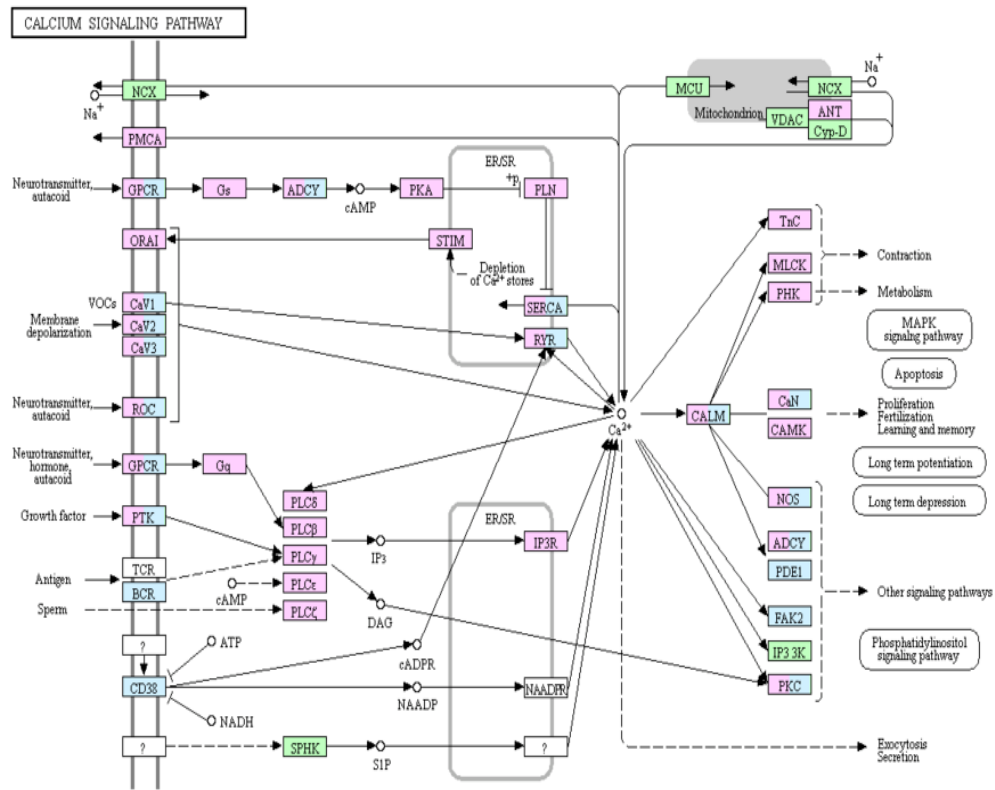

Figure 8. KEGG pathway map (04020) for Calcium Signaling Pathway. The main source of signal  $Ca^{2+}$  is the  $Ca^{2+}$  that enters from outside. The entry is determined by a large electrochemical gradient transversely the plasma membrane. The voltage channels are found on cells that are being excited and therefore generate rapid  $Ca^{2+}$  fluctuations. This cause's rapid increase in concentration in cytoplasmic membrane thus causes signal transduction (M Kanehisa & Goto, 2000; Minoru Kanehisa et al., 2017, 2016).

From table 5, we have seen that only two of the pathways are discussed here, one with the large count number and another with least count number. This is to compare both the pathways and their targets. We have selected 13 pathways just to add the Long Term Depression for understanding the depression pathway better. Many pathways follow the 5HTR pathway. For instance, calcium signaling pathway initiate through GPCR (G protein coupled receptor) followed by cAMP pathway and further proliferation of signaling neurotransmitters.

### 3.3 PPI network construction and hub genes identification:

In evolving biology, it is a challenge to disentangle how frequent genes are temporally stimulated within networks so as to complete specific purposes and regulate developing fate diversity (Boone, Bussey, & Andrews, 2007). These processes are regulated through complicated intracellular signaling network (Arbeitman et al., 2002; Freeman, 2000). To extract suitable information from the enormous data sets that are generated, an overall network map can be formed by organizing the different inputs and outputs among genes contained by a network. The network map offers testable extrapolations and new intuition into the gene program (Oliveri, Tu, & Davidson, 2008; Stathopoulos & Levine, 2005).

The STRING database, a Search Tool to pre-compute global resource and evaluate protein–protein interactions (PPI) information (von Mering et al., 2003) was used to construct PPI networks. There were 48 nodes and 48 edges based on STRING database (table 6). These hub proteins and the associated PPI networks were shown in Figure 8.

Table 5: Summary of constructed PPI network

Number of nodes: 48	Avg. local clustering coefficient: 0.367
Number of edges: 48	Expected number of edges: 10
Average node degree: 2	PPI enrichment p-value: < 1.0e-16

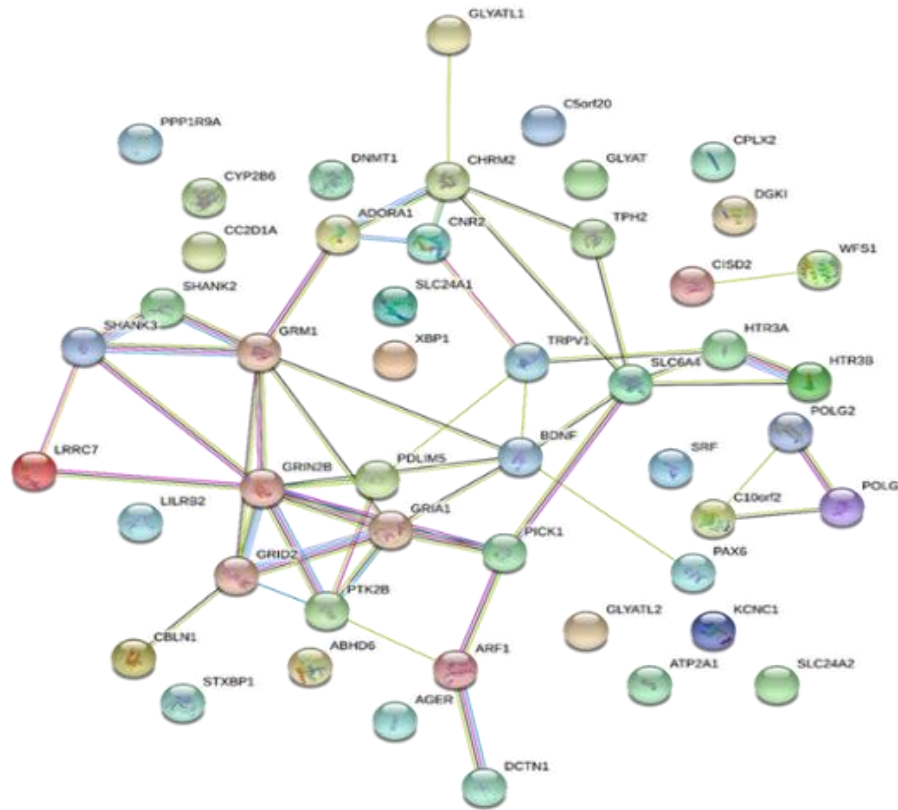

Figure 9. The constructed PPI network of depression, Nodes represent proteins, edges represent interaction between proteins. Local clustering is the tendency of nodes clustering together, the average value is .367 because lower transitivity. PPI enrichment value shows that nodes are not random. Analysis for PPI network was performed using esyN (<http://www.esyn.org/>) (Bean et al., 2014).

Besides signaling over the tyrosine kinase receptors (TRK A, TRK B, and TRK C), the developed neurotrophins NGF, BDNF, and NT3/4 signal through their shared receptor p75NTR. When NGF binds to p75NTR triggers few downstream signaling actions controlling decrease, persistence, propagation, and axon creation, consistent with the cellular context. p75NTR receptor is deprived of any enzymatic action, however enlists other proteins to its individual intracellular domain (Pang et al., 2004). An individuality of p75NTR is the aptitude to bore the pro-neurotrophins, i.e. proNGF and proBDNF (Teng et al., 2005). The biological exploit of neurotrophins is hence controlled by proteolytic cleavage, with preforms favorably stimulating p75NTR, facilitating apoptosis, and advanced forms initiating TRK receptors, to uphold survival (Matsumoto et al., 2008).

Hub genes list is given further down. Here, proBDNF-p75NTR signaling facilitates LTD, long term depression, in the hippocampus (Woo et al., 2005) (while BDNF-TRKB signaling promotes LTP, long term potentiation).

<i>Gene</i>	<i>Full name</i>	<i>Function</i>	<i>Reference</i>
<i>TRK</i>	Tyrosine Kinase Receptor	Neurotrophins receptors; regulates growth and differentiation of nerve cell	(Nakagawara, Azar, Scavarda, & Brodeur, 1994)
<i>BDNF</i>	Brain-Derived Neurotrophic Factor	Neurotransmitter modulator; participates in neural plasticity (important for learning and memory)	(Bathina & Das, 2015)
<i>CYP2B6</i>	Cytochrome P450 2B6	Metabolize drugs including ketamine, methadone in human liver	(Zanger & Klein, 2013)
<i>POLG</i>	Polymerase gamma	Encodes pol $\gamma$ and replicates mitochondrial genome( mtDNA)	(Stumpf, Saneto, & Copeland, 2013)
<i>PICK1</i>	Protein Interacting with C kinase	Only proteins containing PDZ and BAR domains that helps to control neurotransmitter trafficking	(Li, Zhang, Wang, Shen, & Wang, 2016)

Table 6: Hub genes associated with long-term depression

Above mentioned hub genes have multidirectional physiological activities in brain; can be used as biomarkers and might diagnose depression in a more effective way. PPI network gives us the total indication about the hub genes and the interactions between the proteins and their enhancement. A special connection of hub genes in the network is they represent the biological significance of the PPI network. Hub nodes have more complex interactions with mental diseases than with other proteins. In accordance, they also play a vital part in mental conditions. Consequently, identification of the hub proteins may enrich the valuation of disorders advancement, neurodevelopment status, and therapeutic tactics (Potter et al., 1985).

### 3.4 Molecular Docking with established antidepressants drug

The aim of ligand-protein docking is to calculate the predominant binding type(s) of a ligand with a protein of identified three-dimensional assembly. Effective docking methods practice a scoring function that correctly ranks contestant dockings. Docking can also be used to accomplish computer-generated screening on enormous collections of compounds, rank the results, and advise structural hypotheses of inhibition of the target by the ligand (Morris & Lim-Wilby, 2008). Docking is done in both flexible and rigid approaches. Flexible allows movement of molecule as torsions are not fixed, however torsions are fixed in rigid docking (Siam, Hossain, Kabir, & Rajib, 2017). From five different classes of antidepressants a total of 300 drugs and ligands from different classes were chosen to dock with each protein which are more enriched. Drugs having the best results are given.

Among all the 62 proteins, only the proteins that were overlapped within PPI network and KEGG pathways are chosen, and docked with the established drugs. Most drugs did not give results as expected because of the poor binding affinity. Best 5 drugs are here given in table along with ketamine to compare the study for better therapeutic effects. Drugs which gave the best results are tightly bound to the receptors and therefore more therapeutic value.

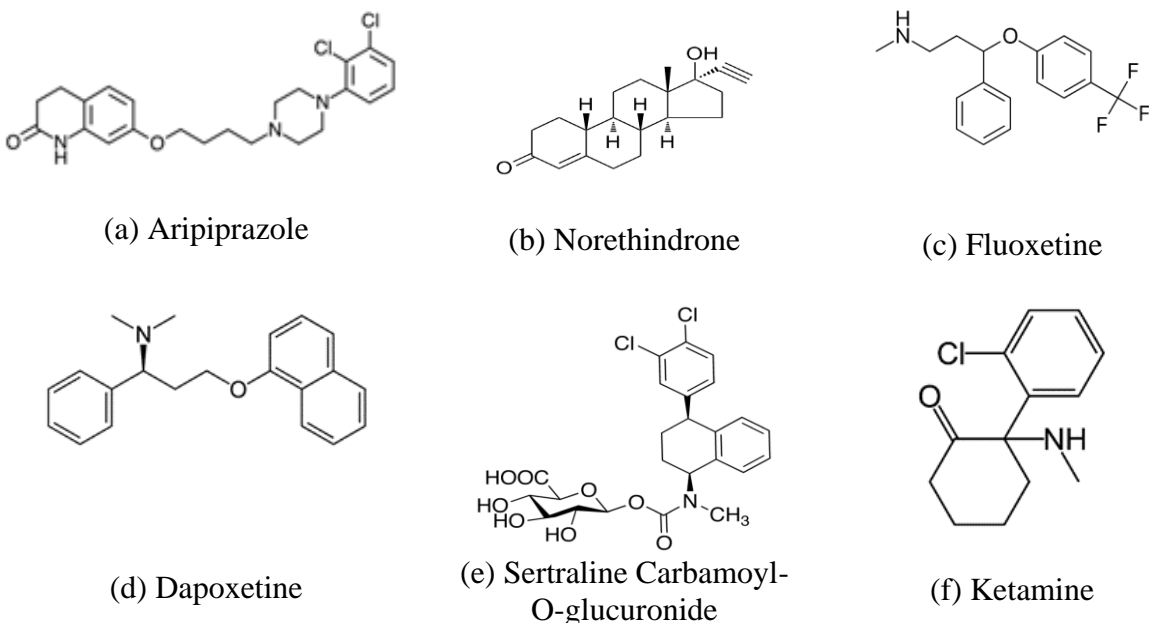

Figure 10. 2D structure of the established drugs

S/ No	Established Drugs	Protein 1	Protein 2	Protei 3	Protein 4	Protein 5	Protein 6	Protein 7
1	Sertraline Carbamoyl	-10.5	-10.2	-10.4	-10.1	-9.7	-9.9	-10.1
2	Norethindro ne	-10.4	-8.9	-8.1	-10.3	10.2	-9.6	8.5
3	Fluoxetine	-9.7	-8.4	-8.4	-8.1	-7.6	8.2	-9.2
4	Dapoxetine	-9.5	-9.2	-9.1	-8.4	-8.9	-8.4	-8.8
5	Aripirazole	-9.3	-9.3	-8.5	-9.1	-9.1	-8.7	-8.1
6	Ketamine	-7.2	-6.9	-6.3	-7.1	-6.2	-6.1	-5.4

Table 7. Best docking results of proteins with established antidepressants

Here,

- Protein 1- Glutamate Receptor Iontropic, delta 2
- Protein 2 - 5-hydroxytryptamine receptor 3A
- Protein 3 - Glutamate receptor ionotropic, NMDA 2B
- Protein 4 Dopamine Receptor, D2
- Protein 5 – Tachykinin Receptor Activity(TACR2)
- Protein 6 - Sodium-dependent serotonin transporter
- Protein 7- DNA polymerase subunit gamma-, y

The results from table 7, the drug Sertraline Carbamoyl-O-glucuronide showed the maximum binding affinity with Glutamate Receptor Iontropic, delta 2 (-10.5), this binds with a signaling receptor that further provides better therapeutic activity. This drug can also be a target choice for therapeutic actions. Although with other proteins the affinity varies due to their bonding.

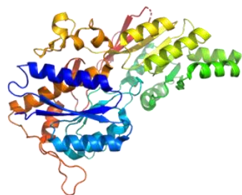

(a) Glutamate receptor  
ionotropic, delta 2  
PDB ID- 5KC8

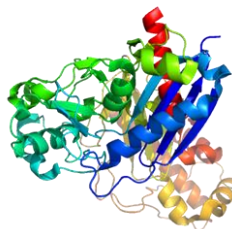

(b) 5 Hydroxytryptamine  
receptor, 3A  
PDB ID- 5HTR



(c) Dopamine Receptor, D2  
PDB ID- 6CM4

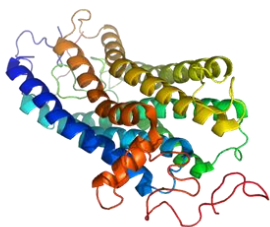

(d) Tackycinin Receptor  
Activity  
PDB ID- 4M48

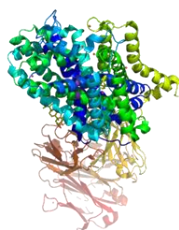

(e) Sodium Dependent Serotonin  
Transporter  
PDB ID- 2KS9

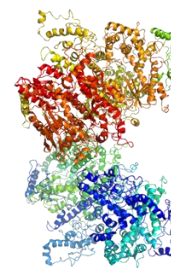

(f) DNA Polymerase  
Subunit gamma 1  
PDB ID- 3IKM

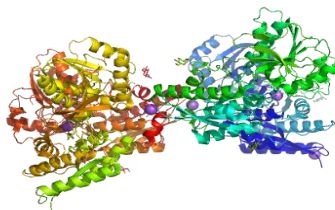

(g): Glutamate receptor ionotropic, NMDA 2B  
PDB ID- 5EWL

Figure 11. Structures of seven selected proteins for docking are given from RCSB PDB ([www.rcsb.org](http://www.rcsb.org)) (H. M. Berman et al., 2000).

# **Chapter Four**

## **Discussion and Conclusion**



To diagnose depression or other psychiatric diseases there has always been lack of proper standard. The phenotypic variability has always been a barrier. Bioinformatics has overcome this situation with tools to identify their signaling pathway and explore the biomarkers in the field of neuropsychiatry and drug abuse (Stahl, 1998). The neurobiology underlying this melancholy has not well-known, but is understood to result from molecular and cellular aberrations that interrelate with genetic and environmental factors (Zhao et al., 2016). As an advanced tool bioinformatics has helped to explore the proteins in different progression level. We collect information about proteins from enriched databases where even the tiniest information is conserved. The work here is to provide new insights in diagnosis of depression and underlying mechanism of it.

In our study, we have total 62 proteins associated with depression and we have screened them and done functional annotation analysis to identify the GO terms. The GO terms are the result of ontological studies representing the clusters and their connection of enrichment of the gene. Among the most five GO terms two most important was transmission of nerve impulse and neural projection (Cook-Snyder, Jones, & Reijmers, 2015). These proteins also involved in mental and cellular processes of brain.

Over the exploration of the KEGG pathway thirteen significant pathways are found. They are also two types' neural pathways and cancer pathways. The neural signal transduction pathway contains neuro active ligand-receptor inter-action pathway which is the most important and also smeared into depression assessment and model analysis. It may alter the pathological condition of disease (Adkins et al., 2012; Kong et al., 2015).

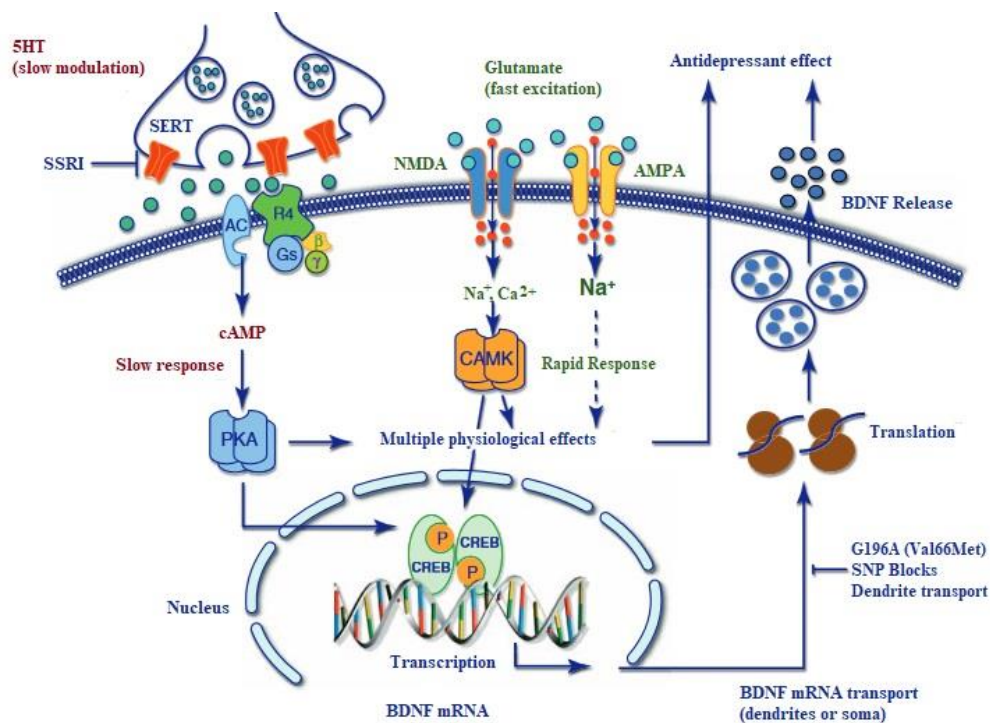

Figure 12. Chronic anti-depressants pathways OF 5HT (SSRI) (Ronald S. Duman, Li, Liu, Duric, & Aghajanian, 2012)

The above pathways are regulated by chronic anti-depressants pathways. 5-hydroxytryptamine (5-HT) is a typical selective serotonin reuptake inhibitors antibiotic which block monoamine reuptake with the help of 5-HT transporter (SERT). It leads to G protein-coupled receptors (postsynaptic) regulation also includes cAMP protein kinase A pathway (R. S. Duman et al., 1997; Krishnan & Nestler, 2008). This process excites the neurons via inotropic receptors as AMPA and NMDA following depolarization and rapid intracellular signaling (Ronald S. Duman & Monteggia, 2006).

With DAVID database we have done functional annotation clustering and found 150 GO terms. Besides, from KEGG pathway we have got 13 significant pathways. According to our reference paper<sup>31</sup> they chose 10 significant pathways, we chose 13 to include the long term depression pathway which is also significant and many anti-depressants follow that pathway. After the common pathways have been selected, we chose proteins that were expressed in those pathways to dock with 300 random drugs from 5 classes of anti-depressants.

Docking results are focused to comprehend whether the drug is sufficient for activating the signaling pathways. Sertraline Carbamoyl-O-glucuronide showed highest binding affinity (table

7) to glutamate receptor, that specify sufficient binding for activating cascade reaction followed by GPCR and cAMP pathway succeeding  $\text{Ca}^{2+}$  fluctuation (figure 8), neurotransmitters releasing to the brain. From the data all proteins are highly expressed in the brain, so the drugs following the pathways are more inclined to bind with target receptors. When the proteins cannot convey suitably, the binding affinity tend to be poor between the drugs and proteins and become nonfunctional. Moreover, the proteins can be targeted for discovering better antidepressants.

One more view of this study shows the effects of ketamine as anti-depressants (Hijazi & Boulieu, 2002). From the result we have seen ketamine is docked against proteins but having very low binding affinity (table 7). the noncompetitive NMDA receptor blocker ketamine provides significant improvement to patients suffering from depression nevertheless its mechanistic pathways are not wholly understood (Kostandy Shenoda, 2014). Ketamine is unique in providing acute response in depressed patients (Dowben, Grant, & Keltner, 2013).

Current clinical studies provide new experimental medications where address limitations of many anti-depressants (Willner, 2005). Specifically, ketamine which has a low dose of NMDA receptor antagonist produce a prompt antidepressant response within hours (R. M. Berman et al., 2000; Zarate, Singh, & Manji, 2006), ketamine provide rapid action to the patients who are resistant to two or more typical antidepressants (Trivedi et al., 2006)

## **Conclusion**

To Comprehend the biology of depression is an inspiring scientific delinquent with massive clinical and sociological consequence. The innovation of antidepressant medications and the exploration of their appliance of action has reformed our indulgent of neuronal functioning and the likely appliances underlying depression. This paper studied depression associated proteins from the appraised database to comprehend the molecular mechanisms of the disease by different bioinformatics methods (Gene Ontology, KEGG, and Protein-protein Interaction Network analysis). The paper suggested that drugs like Sertraline Carbamoyl-O-glucuronide, norethindrone, which targets the depression associated signaling receptor, can be proved to be used as antipsychotic drug for better therapeutic action. In addition to that the hub proteins TRK, BDNF, CYP2B6, POLG, PICK1 have potential and can be targeted as biomarkers for the diagnosis and treatment of psychiatric disease.

Building on these findings, studies could be designed to target and examine the protein clusters commonly associated with depression, it's associated genes, and cross-references to understand psychiatric disease i.e. depression and its transduction targets to design functional biomarkers for early diagnosis.

## References

- Aamer Mehmood, M., Sehar, U., & Ahmad, N. (2014). Use of Bioinformatics Tools in Different Spheres of Life Sciences. *Journal of Data Mining in Genomics & Proteomics*, 05(02), 1–13. <https://doi.org/10.4172/2153-0602.1000158>
- Abreu, P. R., & Santos, C. E. (2008). Behavioral Models of Depression: A Critique of the Emphasis on Positive Reinforcement. *International Journal of Behavioral Consultation and Therapy*, 4(2), 130–145. <https://doi.org/http://dx.doi.org/10.1037/h0100838>
- Adkins, D. E., Khachane, A. N., McClay, J. L., Åberg, K., Bukszár, J., Sullivan, P. F., & van den Oord, E. J. C. G. (2012). SNP-based analysis of neuroactive ligand-receptor interaction pathways implicates PGE2 as a novel mediator of antipsychotic treatment response: Data from the CATIE study. *Schizophrenia Research*. <https://doi.org/10.1016/j.schres.2011.11.002>
- Arbeitman, M. N., Furlong, E. E. M., Imam, F., Johnson, E., Null, B. H., Baker, B. S., ... White, K. P. (2002). Gene expression during the life cycle of *Drosophila melanogaster*. *Science*, 297(5590), 2270–2275. <https://doi.org/10.1126/science.1072152>
- Bathina, S., & Das, U. N. (2015). Brain-derived neurotrophic factor and its clinical Implications. *Archives of Medical Science*, 11(6), 1164–1178. <https://doi.org/10.5114/aoms.2015.56342>
- Battaini, F. (2001). PROTEIN KINASE C ISOFORMS AS THERAPEUTIC TARGETS IN NERVOUS SYSTEM DISEASE STATES. *Pharmacological Research*, 44(5). <https://doi.org/10.1006/phrs.2001.0893>
- Bean, D. M., Heimbach, J., Ficorella, L., Micklem, G., Oliver, S. G., & Favrin, G. (2014). esyN: Network building, sharing and publishing. *PLoS ONE*, 9(9), 1–5. <https://doi.org/10.1371/journal.pone.0106035>
- Berman, H. M., Westbrook, J., Feng, Z., Gilliland, G., Bhat, T. N., Weissig, H., ... Bourne, P. E. (2000). The Protein Data Bank: Nucleic Acids Research. *Oxford Journals*, 28(1), 235–242. <https://doi.org/10.1093/nar/28.1.235>
- Berman, R. M., Cappiello, A., Anand, A., Oren, D. A., Heninger, G. R., Charney, D. S., &

- Krystal, J. H. (2000). Antidepressant effects of ketamine in depressed patients. *Biological Psychiatry*, 47(4), 351–354. [https://doi.org/10.1016/S0006-3223\(99\)00230-9](https://doi.org/10.1016/S0006-3223(99)00230-9)
- Berrettini, W. H. (2001). Molecular linkage studies of bipolar disorders. *Bipolar Disorders*. <https://doi.org/10.1034/j.1399-5618.2001.30603.x>
- Bondy, B. (2002). Pathophysiology of depression and mechanisms of treatment. *Dialogues in Clinical Neuroscience*, 4(1), 7–20.
- Boone, C., Bussey, H., & Andrews, B. J. (2007). Exploring genetic interactions and networks with yeast. *Nature Reviews Genetics*. <https://doi.org/10.1038/nrg2085>
- Brown, G. W., Harris, T. O., & Hepworth, C. (1994). Life Events and Endogenous Depression: A Puzzle Reexamined. *Archives of General Psychiatry*, 51(7), 525–534. <https://doi.org/10.1001/archpsyc.1994.03950070017006>
- Chen, L., Chu, C., Lu, J., Kong, X., Huang, T., & Cai, Y. D. (2015). Gene ontology and KEGG pathway enrichment analysis of a drug target-based classification system. *PLoS ONE*, 10(5). <https://doi.org/10.1371/journal.pone.0126492>
- Cook-Snyder, D. R., Jones, A., & Reijmers, L. G. (2015). A retrograde adeno-associated virus for collecting ribosome-bound mRNA from anatomically defined projection neurons. *Frontiers in Molecular Neuroscience*, 8. <https://doi.org/10.3389/fnmol.2015.00056>
- Coppen, A. (1967). The biochemistry of affective disorders. *The British Journal of Psychiatry : The Journal of Mental Science*, 113(504), 1237–1264. Retrieved from <http://www.ncbi.nlm.nih.gov/pubmed/4169954>
- Coull, M. A., Lowther, S., Katona, C. L. E., & Horton, R. W. (2000). Altered brain protein kinase C in depression: A post-mortem study. *European Neuropsychopharmacology*, 10(4). [https://doi.org/10.1016/S0924-977X\(00\)00084-5](https://doi.org/10.1016/S0924-977X(00)00084-5)
- Craddock, N., Khodel, V., Van Eerdewegh, P., & Reich, T. (1995). Mathematical limits of multilocus models: the genetic transmission of bipolar disorder. *American Journal of Human Genetics*, 57(3), 690–702. Retrieved from <http://www.pubmedcentral.nih.gov/articlerender.fcgi?artid=1801283&tool=pmcentrez&rendertype=abstract>

- Dallakyan, S., & Olson, A. J. (2015). Small-molecule library screening by docking with PyRx. *Methods in Molecular Biology*, 1263, 243–250. [https://doi.org/10.1007/978-1-4939-2269-7\\_19](https://doi.org/10.1007/978-1-4939-2269-7_19)
- DeLano, W. L. (2002). PyMOL: An open-source molecular graphics tool. *CCP4 Newsletter On Protein Crystallography*, 40, 82–92. Retrieved from [pymol.org](http://pymol.org)
- Dibyajyoti, S., Talha Bin, E., & Swati, P. (2013). Bioinformatics: The effects on the cost of drug discovery. *Galle Medical Journal*, 18(1), 44–50. <https://doi.org/10.4038/gmj.v18i1.5511>
- Doğan, T., Macdougall, A., Saidi, R., Poggioli, D., Bateman, A., O'Donovan, C., & Martin, M. J. (2016). UniProt-DAAC: Domain architecture alignment and classification, a new method for automatic functional annotation in UniProtKB. *Bioinformatics*, 32(15), 2264–2271. <https://doi.org/10.1093/bioinformatics/btw114>
- Dowben, J. S., Grant, J. S., & Keltner, N. L. (2013). Biological perspectives: Ketamine as an alternative treatment for treatment-resistant depression. *Perspectives in Psychiatric Care*. <https://doi.org/http://dx.doi.org/10.1111/ppc.12006>
- Duman, R. S., Heninger, G. R., & Nestler, E. J. (1997). A molecular and cellular theory of depression. *Archives of General Psychiatry*. <https://doi.org/10.1001/archpsyc.1997.01830190015002>
- Duman, R. S., Li, N., Liu, R. J., Duric, V., & Aghajanian, G. (2012). Signaling pathways underlying the rapid antidepressant actions of ketamine. *Neuropharmacology*, 62(1), 35–41. <https://doi.org/10.1016/j.neuropharm.2011.08.044>
- Duman, R. S., Malberg, J., & Thome, J. (1999). Neural plasticity to stress and antidepressant treatment. *Biological Psychiatry*. [https://doi.org/10.1016/S0006-3223\(99\)00177-8](https://doi.org/10.1016/S0006-3223(99)00177-8)
- Duman, R. S., & Monteggia, L. M. (2006). A Neurotrophic Model for Stress-Related Mood Disorders. *Biological Psychiatry*. <https://doi.org/10.1016/j.biopsych.2006.02.013>
- Frank, E., Prien, R. F., Jarrett, R. B., Keller, M. B., Kupfer, D. J., Lavori, P. W., ... Weissman, M. M. (1991). Conceptualization and rationale for consensus definitions of terms in major depressive disorder: Remission, recovery, relapse, and recurrence. *Archives of General Psychiatry*, 48(9), 851–855. <https://doi.org/10.1001/archpsyc.1991.01810330075011>

- Freeman, M. (2000). Feedback control of intercellular signalling in development. *Nature*.  
<https://doi.org/10.1038/35042500>
- Guex, N., & Peitsch, M. C. (1997). SWISS-MODEL and the Swiss-PdbViewer: An environment for comparative protein modeling. *Electrophoresis*, *18*(15), 2714–2723.  
<https://doi.org/10.1002/elps.1150181505>
- Gurland, B. (1976). Aims, organization, and initial studies of the Cross-National Project. *International Journal of Aging & Human Development*, *7*(4), 283–293. Retrieved from  
<http://www.ncbi.nlm.nih.gov/pubmed/1024098>
- Hadley, D., Hoff, M., Holik, J., Reimherr, F., Wender, P., Coon, H., & Byerley, W. (1995). Manic-Depression and the Norepinephrine Transporter Gene. *Human Heredity*, *45*(3), 165–168. <https://doi.org/10.1159/000154279>
- Hajek, T., Kozeny, J., Kopecek, M., Alda, M., & Höschl, C. (2008). Reduced subgenual cingulate volumes in mood disorders: A meta-analysis. *Journal of Psychiatry and Neuroscience*.
- Hasler, G., Drevets, W. C., Manji, H. K., & Charney, D. S. (2004). Discovering endophenotypes for major depression. *Neuropsychopharmacology*. <https://doi.org/10.1038/sj.npp.1300506>
- Hijazi, Y., & Boulieu, R. (2002). Protein binding of ketamine and its active metabolites to human serum. *European Journal of Clinical Pharmacology*.  
<https://doi.org/10.1007/s00228-002-0439-4>
- Iyer, K., & Khan, Z. A. (2012). Review Paper Depression – A Review. *International Science Congress Association*, *1*(4), 79–87.
- Kabir, E. R., Siam, M. K. S., Kabir, S. M., Khan, A., & Rajib, S. A. (2017). Drug Repurposing. In *Proceedings of the 8th International Conference on Computational Systems-Biology and Bioinformatics - CSBio '17* (pp. 68–75). New York, New York, USA: ACM Press.  
<https://doi.org/10.1145/3156346.3156359>
- Kandel, E. R., & Squire, L. R. (2000). Neuroscience: Breaking Down Scientific Barriers to the Study of Brain and Mind, *290*(November).



- Kanehisa, M., Furumichi, M., Tanabe, M., Sato, Y., & Morishima, K. (2017). KEGG: New perspectives on genomes, pathways, diseases and drugs. *Nucleic Acids Research*, *45*(D1), D353–D361. <https://doi.org/10.1093/nar/gkw1092>
- Kanehisa, M., & Goto, S. (2000). Kyoto Encyclopedia of Genes and Genomes. *Nucleic Acids Research*, *28*, 27–30. <https://doi.org/10.1093/nar/28.1.27>
- Kanehisa, M., Sato, Y., Kawashima, M., Furumichi, M., & Tanabe, M. (2016). KEGG as a reference resource for gene and protein annotation. *Nucleic Acids Research*, *44*(D1), D457–D462. <https://doi.org/10.1093/nar/gkv1070>
- Katz, M. M., Secunda, S. K., Hirschfeld, R. M. A., & Koslow, S. H. (2015). Collaborative Program on the Psychobiology of Depression.
- Klimek, V., Stockmeier, C., Overholser, J., Meltzer, H. Y., Kalka, S., Dilley, G., & Ordway, G. A. (1997). Reduced levels of norepinephrine transporters in the locus coeruleus in major depression. *The Journal of Neuroscience*, *17*(21), 8451–8458. <https://doi.org/10.1523/JNEUROSCI.17-21-08451.1997>
- Konarski, J. Z., McIntyre, R. S., Kennedy, S. H., Rafi-tari, S., Soczynska, J. K., & Ketter, T. A. (2008). Volumetric neuroimaging investigations in mood disorders: Bipolar disorder versus major depressive disorder. *Bipolar Disorders*. <https://doi.org/10.1111/j.1399-5618.2008.00435.x>
- Kong, Y., Liang, X., Liu, L., Zhang, D., Wan, C., Gan, Z., ... Jiang, B. H. (2015). High throughput sequencing identifies MicroRNAs mediating  $\alpha$ -synuclein toxicity by targeting neuroactive-ligand receptor interaction pathway in early stage of *Drosophila* Parkinson's disease model. *PLoS ONE*, *10*(9). <https://doi.org/10.1371/journal.pone.0137432>
- Kostandy Shenoda, B. B. (2014). The Potential Role of the Endogenous Opioid System in the Antidepressant Effect of Ketamine. *An International Journal Kostandy Shenoda Research in Neurology An International Journal*, *2014*(2014). <https://doi.org/10.5171/2014.733320>
- Krishnan, V., & Nestler, E. J. (2008). The molecular neurobiology of depression. *Nature*, *455*(7215), 894–902. <https://doi.org/10.1038/nature07455>
- Kuhar, M. J., Roth, R. H., & Aghajanian, G. K. (1972). Synthesis of catecholamines in the locus

- coeruleus from 3H-tyrosine in vivo. *Biochemical Pharmacology*, 21(16), 2280–2282.  
[https://doi.org/10.1016/0006-2952\(72\)90047-0](https://doi.org/10.1016/0006-2952(72)90047-0)
- Leonard, B. E. (2000). Evidence for a biochemical lesion in depression. In *Journal of Clinical Psychiatry* (Vol. 61, pp. 12–17).
- Lesch, K. P., Wolozin, B. L., Murphy, D. L., & Reiderer, P. (1993). Primary structure of the human platelet serotonin uptake site: identity with the brain serotonin transporter. *Journal of Neurochemistry*, 60(6), 2319–2322.
- Lewinsohn, P. M., & Libet, J. (1972). Pleasant events, activity schedules, and depressions. *Journal of Abnormal Psychology*, 79(3), 291–295. <https://doi.org/10.1037/h0033207>
- Li, Y.-H., Zhang, N., Wang, Y.-N., Shen, Y., & Wang, Y. (2016). Multiple faces of protein interacting with C kinase 1 (PICK1): Structure, function, and diseases. *Neurochemistry International*, 98, 115–121. <https://doi.org/10.1016/j.neuint.2016.03.001>
- Matsumoto, T., Rauskolb, S., Polack, M., Klose, J., Kolbeck, R., Korte, M., & Barde, Y. A. (2008). Biosynthesis and processing of endogenous BDNF: CNS neurons store and secrete BDNF, not pro-BDNF. *Nature Neuroscience*, 11(2), 131–133.  
<https://doi.org/10.1038/nn2038>
- Matussek, N. (1972). [Biochemistry of depression]. *Journal of Neural Transmission*, 33(3), 223–234. Retrieved from <http://www.ncbi.nlm.nih.gov/pubmed/4565920>
- Morris, G. M., & Lim-Wilby, M. (2008). Molecular docking. *Methods in Molecular Biology*, 443, 365–382. [https://doi.org/10.1007/978-1-59745-177-2\\_19](https://doi.org/10.1007/978-1-59745-177-2_19)
- Musselman, D. L., Evans, D. L., & Nemeroff, C. B. (2014). The relationship of depression to cardiovascular disease. *Journal of the American Medical Association*, 55(July 1998), 580–592. <https://doi.org/10.1001/archpsyc.55.7.580>
- Nakagawara, A., Azar, C. G., Scavarda, N. J., & Brodeur, G. M. (1994). Expression and Function of TRK-B and BDNF in Human Neuroblastomas. *Molecular and Cellular Biology*, 14(1), 759–767. <https://doi.org/10.1128/MCB.14.1.759>. Updated
- O’Boyle, N. M., Banck, M., James, C. A., Morley, C., Vandermeersch, T., & Hutchison, G. R.

- (2011). Open Babel: An Open chemical toolbox. *Journal of Cheminformatics*, 3(10).  
<https://doi.org/10.1186/1758-2946-3-33>
- Oliveri, P., Tu, Q., & Davidson, E. H. (2008). Global regulatory logic for specification of an embryonic cell lineage. *Proceedings of the National Academy of Sciences*, 105(16), 5955–5962. <https://doi.org/10.1073/pnas.0711220105>
- Owens, M. J., & Nemeroff, C. B. (1994). Role of serotonin in the pathophysiology of depression: Focus on the serotonin transporter. In *Clinical Chemistry* (Vol. 40, pp. 288–295).  
<https://doi.org/10.1371/clinchem.2009.123752>
- Pang, P. T., Teng, H. K., Zaitsev, E., Woo, N. T., Sakata, K., Zhen, S., ... Lu, B. (2004). Cleavage of proBDNF by tPA/plasmin is essential for long-term hippocampal plasticity. *Science (New York, N.Y.)*, 306(5695), 487–491. <https://doi.org/10.1126/science.1100135>
- Paykel, E. S., Cooper, Z., Ramana, R., & Hayhurst, H. (1996). Life events, social support and marital relationships in the outcome of severe depression. *Psychological Medicine*, 26(1), 121–133. <https://doi.org/10.1017/S0033291700033766>
- Perry, H. (n.d.). The BRAC Manoshi Project. Retrieved from  
<https://www.coursera.org/learn/health-for-all/lecture/PIEqu/the-brac-manoshi-project>
- Popoli, M., Brunello, N., Perez, J., & Racagni, G. (2000). Second messenger-regulated protein kinases in the brain: Their functional role and the action of antidepressant drugs. *Journal of Neurochemistry*. <https://doi.org/10.1046/j.1471-4159.2000.0740021.x>
- Potter, W. Z., Scheinin, M., Golden, R. N., Rudorfer, M. V., Cowdry, R. W., Calil, H. M., ... Linnoila, M. (1985). Selective Antidepressants and Cerebrospinal Fluid: Lack of Specificity on Norepinephrine and Serotonin Metabolites. *Archives of General Psychiatry*, 42(12), 1171–1177. <https://doi.org/10.1001/archpsyc.1985.01790350045009>
- Robinson, J., Mistry, K., McWilliam, H., Lopez, R., & Marsh, S. G. E. (2009). Ipd-the immuno polymorphism database. *Nucleic Acids Research*, 38(SUPPL.1).  
<https://doi.org/10.1093/nar/gkp879>
- Rot, M. A. H., Mathew, S. J., & Charney, D. S. (2009). Neurobiological mechanisms in major depressive disorder. *Cmaj*, 180(3), 305–313. <https://doi.org/10.1503/cmaj.080697>

- Salomon, R. M., Miller, H. L., Krystal, J. H., Heninger, G. R., & Charney, D. S. (1997). Lack of behavioral effects of monoamine depletion in healthy subjects. *Biological Psychiatry*, *41*(1), 58–64. [https://doi.org/10.1016/0006-3223\(95\)00670-2](https://doi.org/10.1016/0006-3223(95)00670-2)
- Schildkraut, J. J. (1965). the Hypothesis of Supporting of Affective Disorders : Evidence. *American Journal of Psychiatry*, *122*(5), 509–522.
- Schwartz, D. D., Katzenstein, J. M., Hopkins Elisabethand Stabley, D. L., Sol-Church, K., Gripp, K. W., & Axelrad, M. E. (2013). Memory Functioning in Adolescents and Young Adults With Costello Syndrome: Evidence for Relative Preservation in Recognition Memory. *AMERICAN JOURNAL OF MEDICAL GENETICS PART A*, *161*(9), 2258–2265. <https://doi.org/10.1002/ajmg.a.36078>
- Siam, M. K. S., Hossain, M. S., Kabir, E. R., & Rajib, S. A. (2017). In Silico Structure Based Designing of Dihydrofolate Reductase Enzyme Antagonists and Potential Small Molecules That Target DHFR Protein to Inhibit the Folic Acid Biosynthetic Pathways. In *Proceedings of the 8th International Conference on Computational Systems-Biology and Bioinformatics - CSBio '17* (pp. 62–67). New York, New York, USA: ACM Press. <https://doi.org/10.1145/3156346.3156358>
- Stahl, S. M. (1998). Basic psychopharmacology of antidepressants, part 1: Antidepressants have seven distinct mechanisms of action. *The Journal of Clinical Psychiatry*, *59 Suppl 4*, 5–14. Retrieved from <http://www.ncbi.nlm.nih.gov/pubmed/9554316>
- Stathopoulos, A., & Levine, M. (2005). Genomic regulatory networks and animal development. *Developmental Cell*. <https://doi.org/10.1016/j.devcel.2005.09.005>
- Stumpf, J. D., Saneto, R. P., & Copeland, W. C. (2013). Clinical and molecular features of polg-related mitochondrial disease. *Cold Spring Harbor Perspectives in Biology*, *5*(4), 1–17. <https://doi.org/10.1101/cshperspect.a011395>
- Sullivan, S. G., Hussain, R., Threlfall, T., & Bittles, A. H. (2004). The incidence of cancer in people with intellectual disabilities. *Cancer Causes & Control : CCC*, *15*(10), 1021–1025. Retrieved from <http://www.ncbi.nlm.nih.gov/pubmed/15801486>
- Tamura, K., Stecher, G., Peterson, D., Filipinski, A. and Kumar, S. (2013). MEGA6: Molecular

- evolutionary genetics analysis version 6.0. *Molecular Biology and Evolution*, 30(12), 2725–2729. <https://doi.org/10.1093/molbev/mst197>
- Teng, H. K., Teng, K. K., Lee, R., Wright, S., Tevar, S., Almeida, R. D., ... Hempstead, B. L. (2005). ProBDNF induces neuronal apoptosis via activation of a receptor complex of p75NTR and sortilin. *The Journal of Neuroscience : The Official Journal of the Society for Neuroscience*, 25(22), 5455–5463. <https://doi.org/10.1523/JNEUROSCI.5123-04.2005>
- Trivedi, M. H., Rush, A. J., Wisniewski, S. R., Nierenberg, A. A., Warden, D., Ritz, L., ... STAR\*D Study Team. (2006). Evaluation of Outcomes With Citalopram for Depression Using Measurement-Based Care in STAR\*D: Implications for Clinical Practice. *American Journal of Psychiatry*, 163(1), 28–40. <https://doi.org/10.1176/appi.ajp.163.1.28>
- Van der Does, A. J. (2001). The effects of tryptophan depletion on mood and psychiatric symptoms. *Journal of Affective Disorders*. [https://doi.org/10.1016/S0165-0327\(00\)00209-3](https://doi.org/10.1016/S0165-0327(00)00209-3)
- Vinayagam, A., Zirin, J., Roesel, C., Hu, Y., Yilmazel, B., Samsonova, A. A., ... Perrimon, N. (2014). Integrating protein-protein interaction networks with phenotypes reveals signs of interactions. *Nature Methods*, 11(1), 94–99. <https://doi.org/10.1038/nmeth.2733>
- von Mering, C., Huynen, M., Jaeggi, D., Schmidt, S., Bork, P., & Snel, B. (2003). STRING: A database of predicted functional associations between proteins. *Nucleic Acids Research*. <https://doi.org/10.1093/nar/gkg034>
- Wang, L., Huang, C., Yang, M., & Yang, J. Y. (2010). BindN+ for accurate prediction of DNA and RNA-binding residues from protein sequence features. *BMC Systems Biology*, 4(Suppl 1), S3. <https://doi.org/10.1186/1752-0509-4-S1-S3>
- Weissman, M. M., Bland, R. C., Canino, G. J., Faravelli, C., Greenwald, S., Hwu, H. G., ... Yeh, E. K. (1996). Cross-national epidemiology of major depression and bipolar disorder. *JAMA*, 276(4), 293–299. <https://doi.org/10.1001/jama.1996.03540040037030>
- Willner, P. (2005). Chronic Mild Stress (CMS) Revisited: Consistency and Behavioural-Neurobiological Concordance in the Effects of CMS. *Neuropsychobiology*, 52(2), 90–110. <https://doi.org/10.1159/000087097>
- Woo, N. H., Teng, H. K., Siao, C.-J., Chiaruttini, C., Pang, P. T., Milner, T. A., ... Lu, B. (2005).

Activation of p75NTR by proBDNF facilitates hippocampal long-term depression. *Nature Neuroscience*, 8(8), 1069–1077. <https://doi.org/10.1038/nn1510>

Yatham, L. N., Srisurapanont, M., Zis, A. P., & Kusumakar, V. (1997). Comparative studies of the biological distinction between unipolar and bipolar depressions. *Life Sciences*. [https://doi.org/10.1016/S0024-3205\(97\)00432-3](https://doi.org/10.1016/S0024-3205(97)00432-3)

Zanger, U. M., & Klein, K. (2013). Pharmacogenetics of cytochrome P450 2B6 (CYP2B6): Advances on polymorphisms, mechanisms, and clinical relevance. *Frontiers in Genetics*, 4(MAR), 1–12. <https://doi.org/10.3389/fgene.2013.00024>

Zarate, C. A., Singh, J., & Manji, H. K. (2006). Cellular Plasticity Cascades: Targets for the Development of Novel Therapeutics for Bipolar Disorder. *Biological Psychiatry*. <https://doi.org/10.1016/j.biopsych.2005.10.021>

Zhao, W., Yang, W., Zheng, S., Hu, Q., Qiu, P., Huang, X., ... Lan, F. (2016). A new bioinformatic insight into the associated proteins in psychiatric disorders. *SpringerPlus*. <https://doi.org/10.1186/s40064-016-3655-6>