

Design of Metamaterial Loaded Microstrip Patch Antenna Array



Inspiring Excellence

A THESIS SUBMITTED IN PARTIAL FULFILLMENT OF THE REQUIREMENTS
FOR THE DEGREE OF BACHELOR OF SCIENCE IN ELECTRICAL & ELECTRONIC
ENGINEERING

Summer 2018

Submitted by
Tamanna Yeasmin Usha (14221023)
Tarannum Choudhury (14221003)
Hanan Ashrafi Anushka (14121006)

Supervised by

Dr. Md. Hasanuzzaman Sagor
Assistant Professor
Department of Electrical and Electronic Engineering,
BRAC UNIVERSITY

ACCEPTANCE

The undersigned certify that he has read and recommend for acceptance, a thesis entitled “Design of Metamaterial Loaded Microstrip Patch Antenna Array” in partial fulfillment of the requirements of the degree of Bachelor of Science Electrical and Electronic Engineering.

Supervisor:
Dr. Md. Hasanuzzaman Sagor
Assistant Professor
Department of Electrical and Electronic Engineering,
BRAC UNIVERSITY
Email: hasan.sagor@bracu.ac.bd

DECLARATION

We, the undersigned, hereby declare that this thesis contains no material which has been accepted for the award of any other degree or diploma at any university or equivalent institution except where due reference is made in the text of the thesis.

Tamanna Yeasmin Usha

Tarannum Choudhury

Hanan Ashrafi Anushka

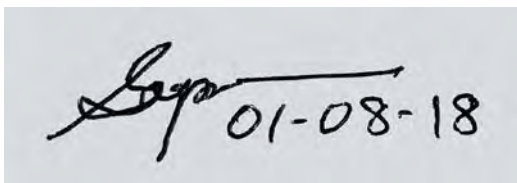
A rectangular box containing a handwritten signature in black ink. The signature is stylized and appears to be 'Sagor'. To the right of the signature, the date '01-08-18' is written in a simple, clear font.

Dr. Md. Hasanuzzaman Sagor

ABSTRACT

Rectangular patch antenna is a commonly used antenna for the microwave ranges. It is easily manufactured and has been studied thoroughly. But its size cannot be reduced as it is inversely proportional to operating frequency. A smaller antenna would operate in frequencies greater than microwaves. To reduce the size of the antenna without affecting its frequency, a microstrip rectangular patch antenna loaded with metamaterials is designed. Metamaterials have unusual electromagnetic properties, as in at certain frequencies ϵ or μ is negative. ENG is added to DPS material as a substrate for the design. This thesis designed an array of such metamaterial loaded antenna elements and compared it to the results of a conventional microstrip patch antenna array. All the designs are simulated on CST Microwave Studio software to ensure that they are viable designs.

ACKNOWLEDGEMENT

We would like to thank our advisor Dr. Md. Hasanuzzaman Sagor for his patience and support. The scope of this thesis would have been too much for us without your support.

We would also like to thank Swad Al Nahiyah for helping and guiding us.

Table of Contents

1. Introduction.....	1
2. Antenna.....	2
2.1. Types of Antenna	2
2.2. Antenna Parameters.....	8
2.3. Microstrip Patch Antenna	14
3. Array	17
3.1 Types of Array Antennas.....	17
3.2 . Feeding Techniques	18
3.3 . Impedance Matching	22
4. Metamaterial	23
5. Literature Review	26
6. Our Designs	28
6.1.Metamaterial Array.....	28
6.2.Conventional Microstrip Array.....	39
6.3.Comparison	50
6.4. Difficulties in Feeding Techniques.....	52
7. Future Work	58
8. Conclusion	59

List of Figures

Figure 1: Log periodic antenna	3
Figure 2: Bow-tie antenna	3
Figure 3: Monopole antenna	5
Figure 4: S parameter system diagram for two port network	12
Figure 5: Bandwidth calculation from S-parameter	13
Figure 6: Rectangular microstrip patch antenna	14
Figure 7: Physical and efficient length of microstrip patch antenna	15
Figure 8: Frequency vs. effective dielectric constant	16
Figure 9: Microstrip patch antenna dimensions	18
Figure 10: Coaxial feed	19
Figure 11: Aperture coupling	19
Figure 12: Equivalent circuit of antenna	20
Figure 13: Quarter-wavelength transformer	22
Figure 14: Metamaterial loaded patch antenna	28
Figure 15: Radiation pattern at 2.8GHz	29
Figure 16: S-parameter of key antenna	30
Figure 17: Diagram of 4-element array	31
Figure 18: 2-element metamaterial array	32
Figure 19: radiation pattern of 2-elements array	33
Figure 20: S-parameter of 2-elements array	33
Figure 21: 4-elements metamaterial array.....	34
Figure 22: Radiation pattern of 4-element array of metamaterial loaded	34
Figure 23: S-parameter of 4-element metamaterial array.....	35
Figure 24: 8-elements array.....	35

Figure 25: Radiation pattern of 8-elements metamaterial loaded array.....	36
Figure 26: S-parameter of 8-elementsmetamaterial loaded array	36
Figure27: S-parameter of 2, 4, 8 elements array of metamaterial loaded antenna	37
Figure 28: Cross-section of radiation pattern along yz-plane	38
Figure 29:2-elemnts array (dimension change)	41
Figure 30: Radiation of 2-element FR4 antenna array with dimension change	41
Figure 31:4-elements dimension change antenna loaded array	42
Figure 32: Radiation pattern for dimension changed antenna loaded 4-elemnets array	42
Figure 33:8-elements dimension changed antenna loaded array	43
Figure 34: Radiation pattern of 8-elements dimension changed loaded antenna array	43
Figure 35: Polar radiation pattern of 2, 4, 8-elements FR4 array with dimension change	44
Figure 36:2-elements same dimension loaded antenna array	46
Figure 37: Radiation pattern of 2-elements FR4 antenna array with same dimension	46
Figure 38:4-elements same dimension antenna loaded array	47
Figure 39: Radiation pattern of 4-elements same dimension antenna loaded array	47
Figure 40:8-elements same dimension antenna loaded array	48
Figure 41: Radiation pattern of8-elements same dimension loaded antenna array	48
Figure 42: Polar radiation of 2, 4, and 8 element arrays of same dimension antenna array	49
Figure 43: S-parameters of all substrates for 8-elements	50
Figure 44: Comparison of gain versus number of elements for all arrays	51
Figure 45: S-parameter for coaxial fed array	53
Figure 46: Front view of coaxial fed array	53
Figure 47: Back view of coaxial fed array.....	53
Figure48: Electric field view for coaxial fed array.....	54
Figure 49: Radiation pattern of coaxial fed array	54
Figure 50: Front view of aperture fed array.....	56

Figure 51: Side view of aperture fed array.....	56
Figure 52: S-parameter for aperture feeding.....	56
Figure 53: Radiation pattern of aperture fed array.....	57
Figure 54: Electric field view for aperture feeding.....	57
Figure 55: Shifting radiation pattern in the future.....	58

List of Tables

Table1: Different Antennas with Directivity.....	10
Table2: Parameters of single metamaterial loaded microstrip patch antenna	29
Table3: Impedance matching calculations for metamaterial loaded patch antenna array.....	31
Table4: Simulation results for metamaterial loaded array	38
Table5: Parameters of patch antenna with dimension change	39
Table6: Impedance matching calculations for FR4 loaded with dimension change antenna array ..	40
Table7: Simulation results for different dimensions array	44
Table8: Parameters of patch antenna with same dimension	45
Table9: Impedance matching calculations for FR4 loaded with same dimension antenna array ...	45
Table10: Simulated results of all same dimension antenna loaded arrays	49
Table11: Calculation for coaxial fed 2-element array	52
Table12: Calculation for aperture fed of 2-element array.....,,	55

1. Introduction

In the past century, the world has experienced a technological revolution. In the past few decades, the goal has been to miniaturize all technology. This is done by decreasing the size of the circuitry inside. This goal has been achieved successfully, but now that the steep curve of improvement has been passed, each incremental improvement requires an astounding amount of effort. Thus, there is a search for new techniques to accomplish what was done before faster and better. For example, there is ongoing research done looking into quantum computing, hoping to maximize the space - physical and digital – of a computer compared to the standard personal computer in everyone’s homes [1].

Antennas have to be created by the $\lambda/2$ rule, where antenna size is inversely proportional to frequency. An antenna for the gigahertz range would be much larger than one for the terahertz range. Manipulating the properties of material using metamaterial can reduce the size of the antenna without changing the value of the desired frequency. Incorporating metamaterial into antennas is still a relatively recent field and there is still much to discover. In this thesis, an 8-element array was created of a rectangular microstrip patch antenna loaded with metamaterials. Multiple arrays were designed in an attempt to understand the ways in which these antennas could be connected.

Chapter 2 covers different kinds of antennas- their names, uses, working principle. It also contains the definitions of some antenna parameters. After that, is an in-depth description of a microstrip patch antenna, which is the antenna used in this thesis. The descriptions continue in chapter 3 which deals with the various types of antenna arrays and some feeding techniques. This chapter includes an impedance matching technique employed later in the designed antenna arrays. Then, chapter 4 discusses the history of metamaterial and its classifications. Chapter 5 contains the literature review of this thesis. Chapter 6 encompasses the array simulations, results, and result analysis. Three arrays (of 2, 4, and 8 elements) were constructed of every kind – the metamaterial loaded antenna and two types of conventional microstrip patch antenna array- for comparison. Moreover, attempts at different feeding methods have also been discussed. Lastly, the ways that research into this topic can continue in the future is discussed in chapter 7.

2. Antenna

In this modern technology dependent world, antennas are vital to everyday use. They are used in wireless local area networks, mobile telephones and satellite communication. An antenna is a transducer that converts radio frequency (RF) fields into alternating current or vice versa. There are both receiving and transmission antennas for sending or receiving radio transmissions. [2] There are various shapes and sizes of antennas from small ones that can be found on one's rooftop to watch TV to really big ones that capture signals from satellites millions of miles away.

How does an antenna work? Antennas have an arrangement of metallic conductors with an electrical connection to receivers or transmitters. Current is forced through these conductors by radio transmitters to create alternating magnetic fields. These fields induce voltage at the antenna terminals, which are connected to the receiver input. In the far field, the oscillating magnetic field is coupled with a similar oscillating electric field, which defines electromagnetic waves capable of propagating the signal for long distances. Radio waves are electromagnetic waves that carry signals through air at the speed of light without any transmission loss. Antennas can be omni-directional, directional or arbitrary. [2]

2.1 Types of Antennas

i. Log-Periodic Antennas

A log-periodic antenna is also known as a log-periodic array or LPDA, a multi-element, directional antenna designed to operate over a wide band of frequencies. This type of antenna is made of a series of half-wave dipoles placed along the antenna axis at different space intervals of time followed by a logarithmic function of frequency. The dipoles are mounted close together in a line, connected in parallel to the feed-line with alternating phase. Sigma and tau are the key design elements of the LPDA design. [4]

Log-periodic antenna has a wide range of applications where variable bandwidth, along with antenna gain and directivity is required.

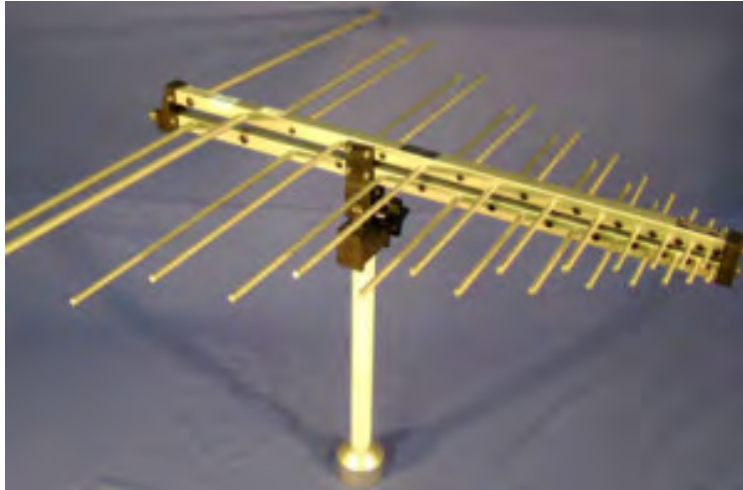

Figure 1: Log periodic antenna

ii. Bow-Tie Antennas

A bow-tie antenna is also known as biconical antenna or butterfly antenna which is also known as an omnidirectional wide-band antenna. Bearing in mind the size of this antenna, it has low- frequency response and acts as a high-pass filter. As the frequency goes to higher limits, away from the design frequency, the radiation pattern of the antenna is distorted and spreads. The bow-tie antenna is planar, and therefore, directional antenna.[5]



Figure 2: Bow-tie antenna

iii. Wire Antennas

Wire antennas are also known as linear or curved antennas. These antennas are very simple, cheap and have wide range of uses. These antennas are further explained below:

a. Dipole Antenna

The dipole antenna consists of two metallic rods through which current and frequency flow. This current and voltage flow makes an electromagnetic wave and the radio signals get radiated. The antenna consists of a radiating element that splits the rods and makes current flow through the center by using a feeder at the transmitter out that takes from the receiver. The different types of dipole antennas used as RF antennas include half wave, multiple, folded, non-resonant, and so on. [6]

b. Short-Dipole Antenna:

A short dipole is formed by two co-linear conductors with a total length L with a small gap between the conductors by a feeder considerably less than a half wavelength ($\frac{1}{2}\lambda$). Short dipoles are sometimes used in applications where a full half-wave dipole would be too large.

c. Half-wave dipole:

A half-wave dipole antenna consists of two quarter-wavelength conductors placed end to end for a total length of approximately $L = \lambda/2$. [6]

The current distribution of a half wave dipole is that of a standing wave, approximately sinusoidal along the length of the dipole, with a node at each end and an antinode (peak current) at the center (feedpoint):

$$I(z) = I_0 e^{i\omega t} \cos kz$$

Where, $k = 2\pi/\lambda$ and z runs from $-L/2$ to $L/2$.

d. Monopole Antenna

A monopole antenna is a single-element antenna usually fed at the bottom with the shield side of its unbalanced transmission line connected to ground, with an omnidirectional radiation pattern. That is it radiates equal power in all azimuthal directions perpendicular to the antenna. It mostly behaves like a dipole antenna. The ground plane is considered to be a conductive surface which works as a reflector. The radiation pattern above the grounded plane will be same as the half wave dipole antenna but the total power radiated is half that of a dipole.

The monopole antennas are used as vehicle mounted antennas as they provide the required ground plane for the antennas mounted above the earth.[7]



Figure 3: Monopole antenna

e. Loop Antenna

Loop antennas come in different shapes like circular, elliptical, rectangular, etc. The fundamental characteristics of the loop antenna are independent of its shape. They are widely used in communication links with the frequency of around 3 GHz. These antennas are used as electromagnetic field probes in the microwave bands.[8]

f. Small Loop Antenna

Small loops are “small” in comparison to their operating wavelength, typically between 5% and 30% of a wavelength in circumference, with transmitting loops tending to be closer to 30%. As with all antennas, smaller antennas are less efficient radiators than larger antennas. [8]

g. Resonant loop :

Resonant loop antennas are relatively large, and are directed by the operation of wavelength. They are also known as large loop antennas as they are used at higher frequencies, such as VHF and UHF, wherein their size is convenient. They can be viewed as folded-dipole antenna and deformed into different shapes like spherical, square, etc., and have similar characteristics such as high-radiation efficiency.

iv. Travelling Wave Antennas

Travelling-wave antenna use travelling wave on a guiding structure as the main radiating mechanism.

a. Helical Antennas:

Helical antennas have two predominate radiation modes: the normal mode and the axial mode. The axial mode is used in a wide range of applications. In the normal mode, the dimensions of the helix are small compared to its wavelength. This antenna acts as the short dipole or monopole antenna. In the axial mode, the dimensions of the helix are same compared to its wavelength. This antenna works as directional antenna.

b. Yagi-Uda Antenna

Another type of antenna that uses passive elements is the Yagi-Uda antenna. This type of antenna is inexpensive and effective. It can be constructed with one or more reflector elements and one or more director elements. Yagi antennas can be made by using an antenna with one reflector, a driven folded-dipole active element, and directors, mounted for horizontal polarization in the forward direction.

v. Microwave Antennas

The antennas operating at microwave frequencies are known as microwave antennas. These antennas are used in a wide range of applications.

a. Rectangular Micro strip Antennas

For spacecraft or aircraft applications – based on the specifications such as size, weight, cost, performance, ease of installation, etc. – low profile antennas are preferred. These antennas are known as rectangular microstrip antennas or patch antennas; they only require space for the feed line which is normally placed behind the ground plane. The major disadvantage of using these antennas is their inefficient and very narrow bandwidth. More is discussed later in this paper.

b. Planar Inverted-F Antennas

A Planar Inverted-F Antenna is a type of linear Inverted F antenna (IFA) in which the wire radiating element is replaced by a plate to increase the bandwidth. One of the advantages of this type of antenna is that they can reduce the backward radiation towards the top of the antenna by absorbing power, which enhances the efficiency since these give high gain in both horizontal and vertical states.

vi. Reflector Antennas

a. Corner Reflector Antenna:

The antenna that comprises one or more dipole elements placed in front of a corner reflector is known as corner-reflector antenna. The directivity of any antenna can be increased by using reflectors.

b. Parabolic-Reflector Antenna:

The radiating surface of a parabolic antenna has very large dimensions compared to its wavelength. One of the useful properties of this antenna is the conversion of a diverging spherical wavefront into parallel wave front that produces a narrow beam of the antenna.

2.2 Antenna Parameters

There are different measurement techniques for measuring the parameters of the typical antenna parameters which are:

- i. Radiation pattern
- ii. Antenna Gain
- iii. Directivity
- iv. S-Parameter
- v. Bandwidth
- vi. Input impedance
- vii. Antenna Efficiency

i. Radiation Pattern

The term Radiation pattern indicates the variation of field intensity of an antenna which is a mathematical function of direction from the antenna. It determines the spatial distribution of radiated energy. [2]

In the fields of fiber optics, lasers, and integrated optics, the term radiation pattern is also used as a synonym for the near-field pattern or Fresnel pattern referring to the positional dependence of the electromagnetic field in the near-field, or Fresnel region of the source.

The near-field pattern is most commonly defined over a plane placed in front of the source, or over a cylindrical or spherical surface enclosing it.

The far field radiation pattern on the other hand may be represented graphically as a plot of one of a number of related variables, including the field strength at a constant large radius an amplitude pattern, the power per unit solid angle power pattern and the directive gain.

The simplest antennas, monopole and dipole antennas, consist of one or two straight metal rods along a common axis. These axially symmetric antennas have radiation patterns with a similar symmetry, called omnidirectional patterns; they radiate equal power in all directions

perpendicular to the antenna, with the power varying only with the angle to the axis, dropping off to zero on the antenna's axis. This illustrates the general principle that if the shape of an antenna is symmetrical, its radiation pattern will have the same symmetry.

ii. Antenna Gain:

Antenna gain is the measurement of transmitted power in the direction of peak radiation from an isotropic source. The antenna transmitting the power helps find how converting the input power into radio waves towards a specific direction gives the receiving antenna the information about electrical power converted from radio waves by the receiver antenna.

Antenna gain can also be found as a product of directivity and efficiency.

$$G = \eta_{\text{rad}} \times D$$

Here,

G=Gain of the Antenna

η_{rad} = Radiation efficiency and

D=Directivity

Gain is always less than or equal to directivity. The term gain is more frequently used than directivity for any antenna's specification.

Gain is measured in decibels (a logarithmic scale) where G is the gain factor.

$$G_{\text{dBi}} = 10 \times \log_{10}(G)$$

Antenna gain produces amplification that focuses on the actual strength of a transmitted or received signal. The gain is proportional to its electrical size. At higher operating frequencies more gain for a specific antenna size is obtained. In some cases gain is measured as a function of angle. For a real antenna gain can reach up to 50 dB, although it is very rare. Theoretically gain cannot be below 0 dB but it is possible to have a very low gain as different losses are present and due to low efficiency.

iii. Directivity:

Directivity is defined as the ability of an antenna to radiate energy in a fixed direction. It is the maximum directive gain of an antenna and the ratio of the maximum radiation intensity to the average radiation intensity.

$$D = \frac{U_{max}}{U_{av}} = \frac{4\pi U_{max}}{P_r}$$

Where,

U_{max} =maximum radiation intensity

U_{av} =average radiation intensity

P_r =total power radiated

Directivity can also be expressed in terms of beam area.

$$D = \frac{4\pi}{\Omega_A}; \quad \Omega_A \text{ Beam area}$$

For small beam area, directivity will be larger. An increase in directivity refers to the fact that the antenna is more directional or more focused. For communication purpose like satellite telephones, satellite TV, satellite internet directivity is quite high.

This is a list of different antennas and their directivity:

Table 1: Different Antennas with Directivity

Antenna Type	Typical Directivity	Typical Directivity(dB)
Short Dip[ole Antenna	1.5	1.76
Half-Wave Dipole Antenna	1.64	2.15
Patch(Microstrip)Antenna	3.2-6.3	5-8
Horn Antenna	10-100	10-20
Dish Antenna	10-10,000	10-40

iv. S-Parameters:

Scattering parameters or S-parameters are terminology used in electrical engineering and communication systems to describe the electrical behavior of linear electrical networks when undergoing various steady state stimuli by small signals. [10]

S-parameters are mostly measured and specified for networks operating at RF and microwave frequencies as they represent parameters particularly useful at RF. In general, S-parameters change with the measurement frequency so this must be included for any S-parameter measurements stated.

The following information must be defined when specifying a set of S-parameters:

- The frequency
- The nominal characteristic impedance (often 50 Ω)
- The allocation of port numbers
- Conditions which may affect the network, such as temperature, control voltage, and bias current, where applicable.

S-parameter describes the input-output relationship of an N-port network to signals incident to any of the ports in an electrical system. S-Parameters are complex numbers that show reflection/transmission characteristics in frequency domain. The magnitude and the phase of the incident signal get changed by the network.

The convention followed to describe S parameter is- power transferred from port M to N is represented by S_{NM} . For example, if we have two ports, there will be 4 S-parameters (S_{11} , S_{12} , S_{21} , S_{22}). S_{22} represents the power transferred from 2 to 1 and S_{21} represents the power transferred from 1 to 2. S_{11} and S_{22} are reflection coefficient. S_{11} represents the power ratio 1 is delivering to antenna 1 and S_{22} represents the power ratio 2 is delivering to antenna 2. [9]

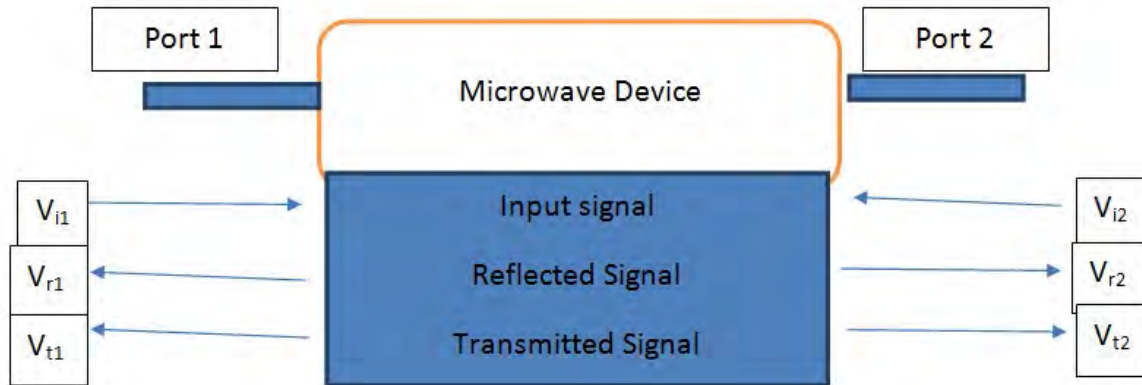

Figure 4:S parameter system diagram for two port network

S_{11} is the most commonly used parameter in case of antenna. It mainly represents how much power is reflected by the antenna. It is also known as the reflection coefficient.

Types of S-parameters:

Small Signal S-parameter: Among all the types of S-parameter this most widely used. Signals for which gain compression, non-linear effects do not take place are known as small signal.

- Large signal S-parameter: Large signal S-parameters are more complicated. For large signal the S-matrix will vary depending upon the input signal strength.
- Pulsed S-parameters: They are measured on power devices so that an accurate representation is captured before the device heats up.
- Mixed-mode S-parameters: It refers to a special case of analyzing balanced circuits.

v. Bandwidth:

Bandwidth is the difference between the high and low frequencies of a signal. In other word bandwidth is the range of frequencies over which a particular antenna can radiate and receive energy properly. For example if a signal transmits between 60 and 70 MHz then it has a bandwidth of 10 MHz.

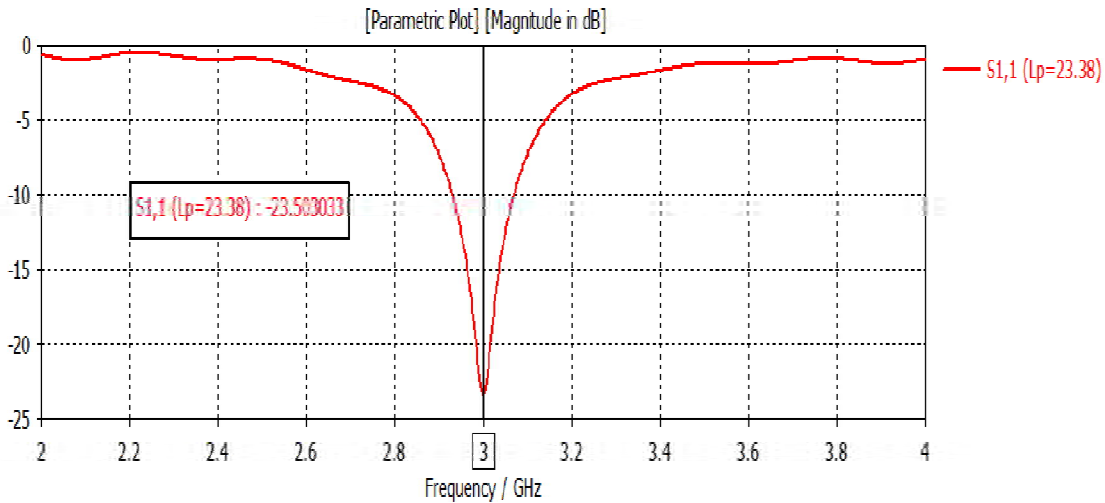

Figure 5: Bandwidth calculation from S-parameter

Bandwidth can be described through many parameters.

vi. Input Impedance:

The input impedance of an antenna refers to the ratio of voltage to current at the input terminal of the antenna. Input impedance of an antenna is normally denoted by Z_{in} . It can be expressed by the following equation,

$$Z_{in} = R_A + jX_A$$

Where,

R_A = Antenna resistance at input terminal

X_A = Antenna reactance at input terminal

vii. Antenna Efficiency:

Antenna efficiency is one of the very important parameters of antenna. It is the ratio of the power delivered to the antenna to the power radiated from the antenna. A high efficiency antenna radiates most of the power delivered as input, while a low efficiency antenna absorbs most of the power as losses. The antenna efficiency can be expressed as a ratio of radiated power to the input power

$$\epsilon_R = \frac{P_{radiated}}{P_{input}}$$

The efficiency of an antenna is always the same whether it is used as a transmitter or receiver. As the efficiency is number between 0 and 1, it is most often represented in terms of percentage. [36]

2.3 Microstrip Patch Antenna

Microstrip antenna is very popular in mobile and satellite communication. In 1950, microstrip antenna was first introduced by Robert E Munson. But it got noticeable attention after 20 years when PCB technology had been developed. Rectangular microstrip antenna is one of the very known and popular configurations for its small size, low profile, easy to design, fabrication and feed.

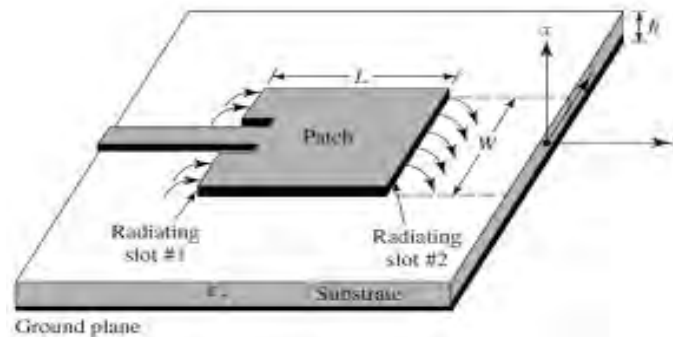

Figure 6: Rectangular microstrip patch antenna

Rectangular microstrip antenna consists of three elements: patch, ground and dielectric substrate. Dielectric substrate is used to keep separate patch and ground. The size of microstrip antenna depends on resonant frequency and dielectric constant of substrate. The length and width of the patch is calculated from resonant frequency and dimensions are also different with respect to frequency. Moreover, dielectric substrate plays a vital role in design of rectangular microstrip antenna. Normally, the range of dielectric constant which is used for microstrip antenna is $2.2 \leq \epsilon_r \leq 12$. The height of substrate and its dielectric constant has impact on efficiency and bandwidth. Microstrip antenna with thick substrate and low

dielectric constant has better efficiency and large bandwidth. However, it requires large dimensions at the same time. On the other hand if thin substrate with higher dielectric constant is used in order to keep dimension small it affects the gain and bandwidth. In addition, the equations those are used to calculate the length and width of microstrip patch antenna where resonant frequency and height of the microstrip antenna are predefined are given below:

Width [11]:

$$W = \frac{1}{2f_r \sqrt{\mu_0 \epsilon_0} \sqrt{\epsilon_r + 1}} = \frac{v_0}{2f_r \sqrt{\epsilon_r + 1}} \quad (1)$$

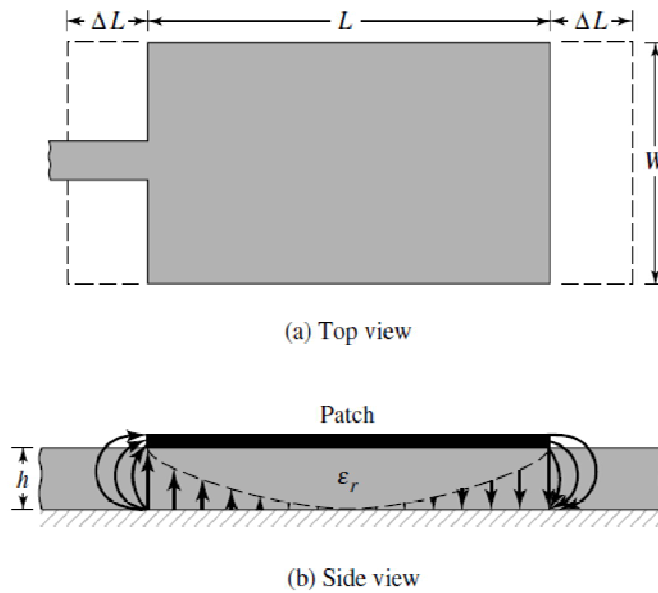

Figure 7: Physical and efficient length of microstrip patch antenna

Length [12]:

$$L = \frac{1}{2f_r \sqrt{\epsilon_{reff}} \sqrt{\mu_0 \epsilon_0}} - 2\Delta L \quad (2)$$

Here, ΔL is the extended distance. Practically the patch is electrically wider compared to its physical dimension because of fringing effect.

$$\frac{\Delta L}{h} = 0.412 \frac{(\epsilon_{reff} + 0.3) \left(\frac{W}{h} + 0.264\right)}{(\epsilon_{reff} - 0.258) \left(\frac{W}{h} + 0.8\right)} \quad (3)$$

Effective dielectric constant [13]:

$$\epsilon_{reff} = \frac{\epsilon_r + 1}{2} + \frac{\epsilon_r - 1}{2} \left[1 + 12 \frac{h}{w} \right]^{(1/2)} \quad (4)$$

For lower resonant frequency, the effective dielectric constant remains constant whether it increases for higher resonant frequency and for much higher frequency it settles down. The figure frequency vs effective dielectric constant is given below:

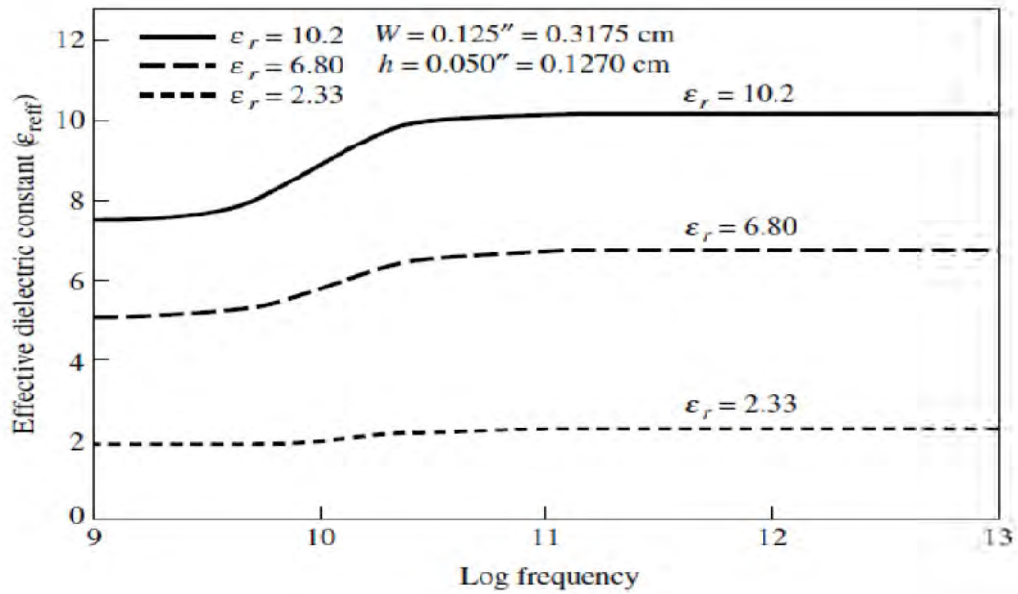

Figure 8: Frequency vs. effective dielectric constant

3. Arrays

An antenna array or array antenna is a single antenna which works when a multiple set of antennas are connected together to transmit or receive radio waves. The individual antennas, often called elements are connected to a single receiver or transmitter by feed lines that feed the power to the elements in a specific phase relationship. The radio waves radiated by each individual antenna combine and superpose, adding together to enhance the power radiated in desired directions, and cancelling to reduce the power radiated in other directions and vice versa.

An antenna array can achieve higher gain (directivity), which is a narrower beam of radio waves, than could be achieved by a single antenna. In general, the larger the number of individual antenna elements used, the higher the gain and the narrower the beam.

3.1 Types of array antenna

Most array antennas are mainly divided into two types:

Broadside array: this array is a one or two dimensional array in which the direction of radiation of the radio waves is perpendicular to the plane of the antennas. To radiate perpendicularly, the antennas must be fed in phase.

Ordinary end-fire array is a linear array in which the direction of radiation is along the line of the antennas. The antennas must be fed with a phase difference equal to the separation of adjacent antennas.

There are even more types of arrays such as:

- Microstrip antenna array which is an array of patch antennas fabricated on a printed circuit board with copper foil on the reverse side functioning as a reflector.
- Phased array is an array in which the beam can be steered electronically to point in any direction over a wide angle in front of the array, without physically moving the antenna. By changing the relative phase of the feed currents, the beam can instantly be pointed in different directions.

- Planar array which is a flat two-dimensional array of antennas. Since an array of omnidirectional antennas radiates two beams 180° apart broadside from both sides of the antenna. [14]

3.2 Feeding techniques

Microstrip line feed, coaxial probe, aperture coupling and proximity coupling are the most popular feeding techniques for microstrip patch antenna. Those feeding techniques are described below:

i. Microstrip feed line:

Among all feeding techniques, microstrip-feed line is the easiest to construct as a conducting strip can be directly connected to the edge of the patch. The width of the strip is very small compared to the patch width. Furthermore, it is easy to match impedance by a method called inset cut which is implemented into patch. In order to implement inset cut, we have to find out proper inset position.

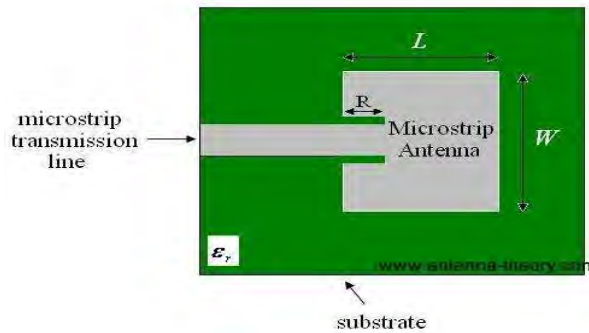

Figure 9: Microstrip patch antenna dimensions

Inset feed is used because the impedance of the transmission line can be matched closer to the impedance of the center of the patch as the transmission line is cut closer to it. This increases current distribution as well as voltage in the patch. The formula is given below for calculating input impedance, where Z_{in} is the input impedance if the patch was fed at the end:

$$Z_{in}(R) = \cos^2\left(\frac{\pi R}{L}\right) Z_{in}(0)$$

ii. Coaxial Feed:

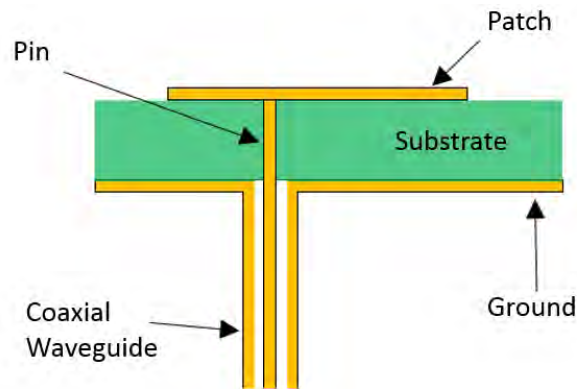

Figure 10: Coaxial feed

Another way to feed an antenna is by coaxial feed. The inner conductor of the coaxial line is connected to the patch and the outer conductor is connected to the ground of the patch antenna. The space in between the two conductors of the coaxial feed line is connected to the substrate. This is a simple method to obtain impedance matching because the coaxial line can be placed at any point in the patch. A drawback of this method is that it gives a very narrow bandwidth. Also, drilling a hole to attach coaxial feed results in an increase in input impedance.

iii. Aperture Coupling:

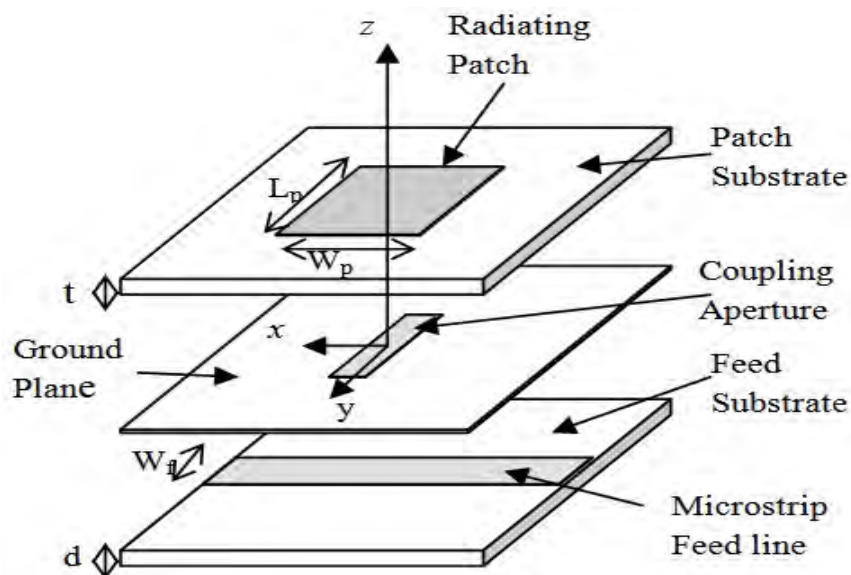

Figure 11: Aperture coupling

There are two substrates and a ground plane in between them. The microstrip line is etched to the feed substrate and the patch is etched onto the antenna substrate. The bottom substrate is made of a high dielectric material and the bottom is made of a low dielectric material. The multiple layers make this type of antenna feeding more complicated.

Transmission line model:

Designing an array involves connecting single antenna elements together and so requires calculation to ensure that the impedances match. Fig[12] shows an equivalent circuit of single antenna. Here, B means susceptance and G means conductance of the antenna. A patch antenna has two radiating slots. B_1 and G_1 correspond to the values of the first radiating slot and so on. The first set of equations give an accurate value for B_1 and G_1 but the second equation for G_1 is simpler and gives an approximate value. Then R_{in} is calculated and so the width of the microstrip feed line can be calculated. [9]

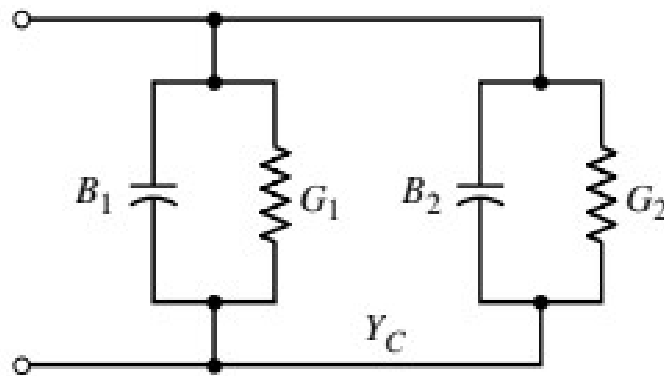

Figure 12: Equivalent circuit of antenna

$$\begin{aligned}
G_1 &= \frac{W}{120\lambda_0} \left[1 - \frac{1}{24} (k_0 h)^2 \right] & \frac{h}{\lambda_0} < \frac{1}{10} \\
B_1 &= \frac{W}{120\lambda_0} [1 - 0.636 \ln(k_0 h)] & \frac{h}{\lambda_0} < \frac{1}{10}
\end{aligned} \tag{5}$$

$$G_1 = \begin{cases} \frac{1}{90} \left(\frac{W}{\lambda_0} \right)^2 & W \ll \lambda_0 \\ \frac{1}{120} \left(\frac{W}{\lambda_0} \right) & W \gg \lambda_0 \end{cases} \tag{6}$$

Equations for Width calculation for microstrip line [9]:

$$Z_0 = \frac{60}{\sqrt{\epsilon_{eff}}} \ln \left[\frac{8h}{W_0} + \frac{W_0}{4h} \right] \quad \text{when } \frac{W_0}{h} \leq 1 \tag{7}$$

$$Z_0 = \frac{120\pi}{\sqrt{\epsilon_{eff}} \left[\frac{W_0}{h} + 1.393 + 0.667 \ln \left(\frac{W_0}{h} + 1.444 \right) \right]} \quad \text{when } \frac{W_0}{h} > 1 \tag{8}$$

Equation for R_{in} calculation [10]:

$$R_{in=5} \times \frac{1+S_{11}}{1-S_{11}} \tag{9}$$

3.3 Impedance matching

Quarter-wavelength transformer:

Quarter-wavelength transformer is a method to match the impedance of the antenna to the feeding line. It is also used at every junction of the transmission feed line where the impedance differs.

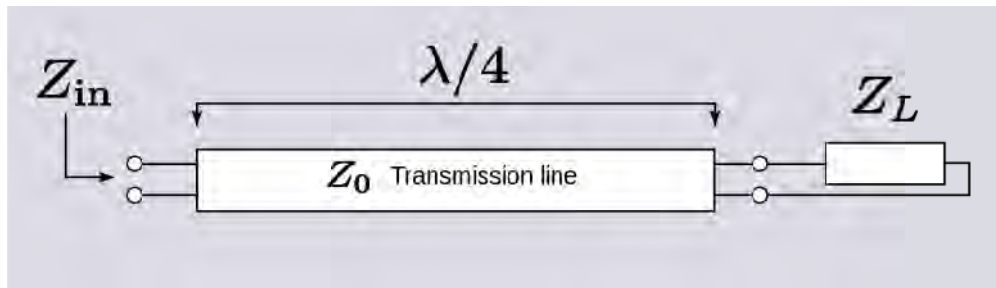

Figure 13: Quarter-wavelength transformer

The formula for calculation z_0 is given below:

$$Z_0 = \sqrt{Z_{in} Z_L}. \quad (10)$$

Here, Z_0 is impedance of quarter wave transmission.

In this research, quarter wave transmission method has been used to match impedance.

4. Metamaterials

A metamaterial, taken from the Greek word μετά meta which means "beyond", is a new artificial materials with unusual electromagnetic properties that have a property that is not found in nature. All materials found in nature such as glass, diamond and such have positive electrical permittivity, magnetic permeability and a refractive index. In these new artificially fabricated materials - termed as negative index materials or double negative media or left handed materials or backward wave media - all these material parameters are negative. With these unusual material parameters, new kinds of miniaturized antennas and microwave components can be created for the wireless communications and defense industries. The electrical permittivity and the magnetic permeability are the main determinants of a material's response to electromagnetic waves. In metamaterials, both these material parameters are negative. Therefore, the refractive index of the metamaterials is also negative. [16]

History of metamaterials:

Experimentations to make artificial materials by manipulating electromagnetic waves began at the end of the 19th century. Some of the earliest structures that may be considered metamaterials were studied by Jagadish Chandra Bose, who in 1898 researched substances with chiral properties. In the early twentieth century Karl Ferdinand Lindman studied wave interaction with metallic helices as artificial chiral media.

Winston E. Kock, developed materials that were similar in characteristics to metamaterials, during the late 1940s. In the 1950s and 1960s, artificial dielectrics were studied for lightweight microwave antennas. Microwave radar absorbers were researched in the 1980s and 1990s as applications for artificial chiral media. [16]

Negative-index materials were first explained theoretically by Victor Veselago in 1967. He proved that such materials could transmit light. He showed that the phase velocity could be made anti-parallel to the direction of Poynting vector. [17][18]

John Pendry was the first to identify a practical way to make a left-handed metamaterial, a material in which does not follow the right-hand rule. [17] Such a material allows an electromagnetic wave to convey energy against its phase velocity.

Around the early 2000's, the functioning of electromagnetic metamaterials by horizontally stacking, periodically, split-ring resonators and thin wire structures to realize negative-index metamaterials using artificial lumped-element loaded transmission lines in microstrip technology was demonstrated. Complex negative refractive index and imaging by flat lens using left handed metamaterials were demonstrated [19]. At microwave frequencies, the first, imperfect invisibility cloak was made in 2006. [20]

Effective Media of Metamaterials:

Metamaterial substrates have specific aptitudes to control and manipulate electromagnetic fields. These are known as effective media when the unit cells and the periods are smaller than the wavelength. One of the major properties of effective media is that the incident radiation sees the structure as a homogeneous medium with viable properties.

The propagation of electromagnetic waves can be characterized depending on the magnitudes of μ and ϵ . Based on if the μ and ϵ are positive or negative different materials can be clarified into different types.

Double Positive (DPS) Material :

Materials having both permittivity and permeability more prominent than zero ($\epsilon > 0$, $\mu > 0$) is called double positive (DPS) medium. Media such as dielectrics fall under this category.

Epsilon Negative (ENG) Material:

The material which has permittivity less than zero and permeability greater than zero ($\epsilon < 0$, $\mu > 0$) is called as epsilon negative (ENG or SNG) material. Many plasma exhibits this type of phenomena in particular frequency region.

Mu Negative (MNG) Material :

The material having more than zero permittivity and less than zero permeability ($\epsilon > 0$, $\mu < 0$) is called as Mu negative (MNG or SNG) material. Some of the gyro tropic materials exhibit this kind of phenomena in particular frequency regions.

Double Negative (DNG) Material:

The material which has permittivity and permeability less than zero ($\epsilon < 0, \mu < 0$) is called as Double negative (DNG) material, which is made artificially.

All of these materials along with their properties can be found from the study of the equation describing the propagation of electromagnetic waves in media as follows:

$$\text{Refraction index } \eta = \mu\epsilon$$

$$\text{And propagation constant, } k = (\omega/c)^2 \times \eta^2$$

From these two equations it can be found that propagation of wave is possible if both μ and ϵ are positive or if both are negative. SNG materials are very useful in designing artificial materials and sometimes even more efficient than DNG or DPS.

5. Literature Review

Microstrip patch antennas are a popular choice for antenna applications due to their numerous advantages such as easy fabrication, low cost, light weight [21]. Despite these benefits there is still research to improve several aspects such as the size, low gain, low impedance bandwidth, etc. Size reduction alone comprises of several methods. Introducing slots in the patch leads to a wider bandwidth but the polarization is poor and the fabrication can be complex. Shorting pins cost effective higher size reduction. The first paper to create a design for a metamaterial-DPS juxtaposed layer loaded rectangular patch antenna was [22]. It proposed a smaller antenna which would have a higher mode operation. An algorithm was also designed to calculate the parameters necessary for such an antenna, which has been used in this paper. Santillán-Haro et al. [23] proposed to create single layer metamaterial lens antenna which one will worked at 10GHz frequency. In this proposed design. Metamaterial was used to get better directivity at 10GHz operating frequency. F.Zhu et al. [24] used metamaterial as a cover of patch antenna. In this design, use of metamaterial cover increased the antenna's directivity, return loss at 2.57GHz compared to the conventional single patch antenna.

Methodology

In this thesis, all the antenna arrays were based on a particular design of microstrip patch antenna. The algorithm to figure out the parameters of the metamaterial used in the antenna was proposed by [25]. It takes input μ_2 and gives an output ϵ_2 and filling ratio η at resonant frequency. Thus the antenna can be designed using these dimensions. This algorithm was then used by [26] to create a microstrip patch antenna loaded with metamaterial at the resonant frequency of 2.3GHz. The substrate employed in this design was a DPS-ENG juxtaposed layer. Although the paper works on improving the gain and radiation efficiency of the higher order modes, this thesis focuses only on operation of TM₀₁₀ mode. Most importantly, this design proposed by [26] and the subsequent arrays based on it experience a significant reduction in size in comparison to conventional microstrip patch antennas. The width of the single element antenna is reduced by 45.27%

This paper [26] suggested not only size reduction but also a shift in radiation pattern. In operating in a higher resonance mode, the side lobe levels are decreased. The single antenna has been recreated from the values and techniques used here to create the array of this thesis.

In [27] the microstrip patch antenna was operated at 5.5GHz and used metamaterials to enhance cross polarization. This operated at TM_{020} mode. However, this thesis dealt with TM_{010} mode. There is a dearth of papers that research the lower TM modes involved in metamaterial loaded rectangular patch antenna.

There are numerous journals and conferences that explored many ways to incorporate metamaterial but there are few papers that are specifically relevant to the lower TM modes.[28] Most of them are about operating in the higher modes. Others are about antennas other than rectangular microstrip patch antenna. [29]

Application

Microstrip antenna is popular as the design and fabrication are easy compared to others. This antenna array is used in mobile, satellite communication, global positioning system, radio frequency identification (RFI), WiMax [30]. As metamaterial loaded antenna array has consumed less space than other conventional patch antenna array, by increasing the numbers of antennas using same space can increase the efficiency (gain, directivity, power efficiency) of these applications.

6. Our Designs

All antennas were simulated on CST Microwave Studio software.

6.1 Metamaterial Array

Key Microstrip Antenna:

In Nahiyan et al. [26] designed rectangular microstrip patch antenna loaded with ENG metamaterial of dimension $25\text{mm} \times 18\text{mm}$. The ratio of ENG and DPS of substrate is calculated by an algorithm and for this design it is 0.911. This antenna has partially end fire radiation pattern with 45 degree deviation of main lobe. Here, the radiating slot is respect with width (W). All parameters and figure of key metamaterial loaded microstrip patch antenna are given below:

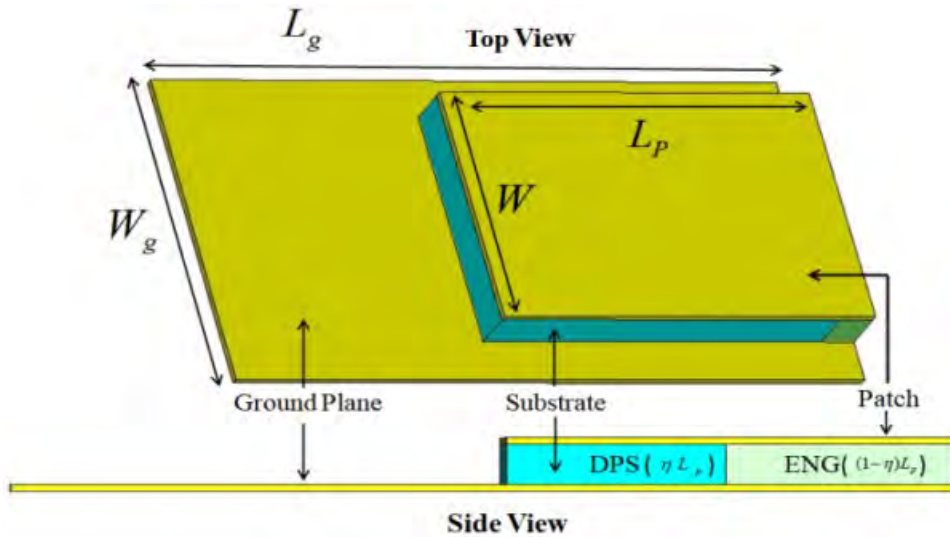

Figure 14: Metamaterial loaded patch antenna

Table 2: Parameters of single metamaterial loaded microstrip patch antenna

Parameter	Values
Length	25mm
Width	18mm
Height (substrate)	4mm
ϵ of DPS	6.4
μ of DPS	1
ϵ of ENG	-0.09
μ of ENG	1
H	0.911
Resonance frequency	2.8GHz

Radiation pattern for key antenna:

From **fig.15**, it is found that the gain at 2.8 GHz is 4.65dB which is very good compared to others and has good directivity.

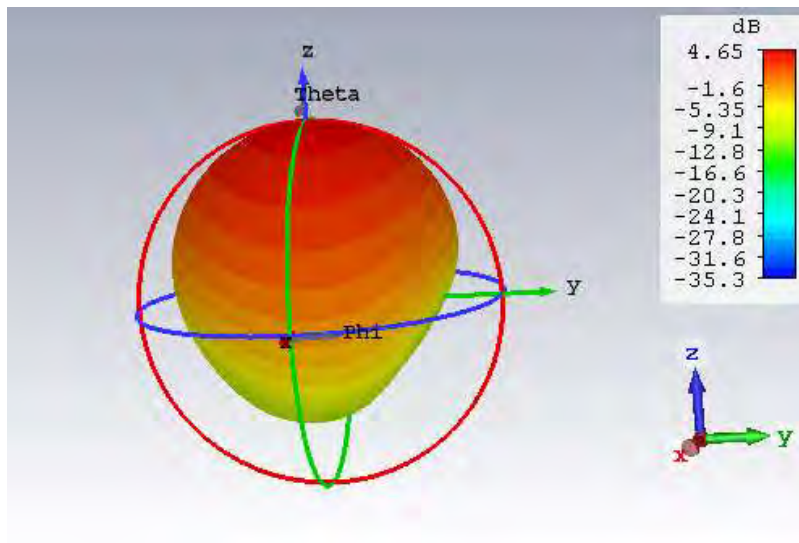

Figure 15: Radiation pattern at 2.8GHz

S-parameter:

As shown of **fig.16**, it is found that return loss at 2.82GHz is -28.85dB which is really good as this value is more than -10dB. In antenna theory, return loss less than -10 dB means more than 50% percent power is wasted (reflected).

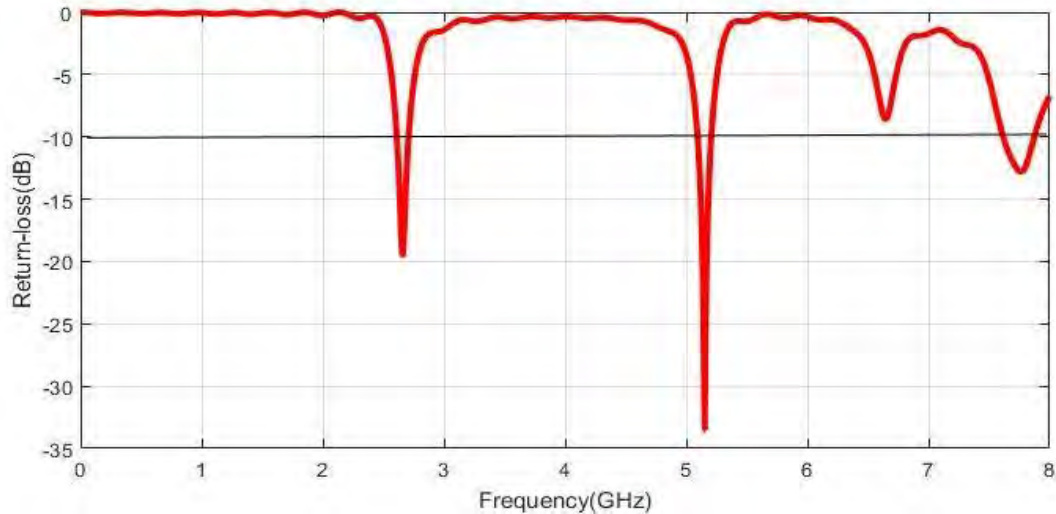

Figure 16: S-parameter of key antenna

Diagram of 4-elements array:

In this research, different types of feeding techniques were tested to get good results. Among all techniques, comparatively good results were got by using microstrip feed technique.

Quarter wave transformer method was used to match the impedance of the antenna to the 50,100-ohm feeding line.

In 4-elements array design (**fig.17**), each metamaterial loaded patch antenna has element resistance R_{in} ($R_{in} = 1/2G_1$). This linear array will be fed with 50-ohm microstrip transmission line into 100-ohm microstrip transmission line. Quarter wave transformers Z_1 and Z_2 will be used to match impedance between R_{in} , 100-ohm and 50-ohm, 100-ohm respectively. To keep separation between antennas, $\lambda/4$ mm distance is maintained.

For 8-elements array, this diagram will be used where another 4-elements array will be connected and further impedance matching will be done by the same way as made for Z_1 and Z_2 .

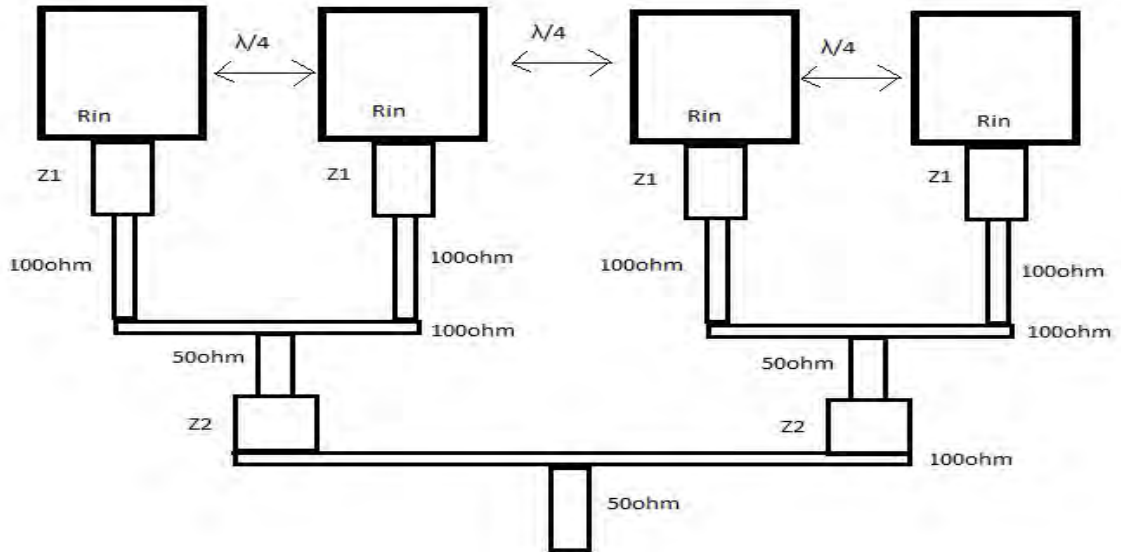

Figure 17: Diagram of 4-element array

Using the previously given equations (7),(8), (9) and (10),the impedances of quarter wavelength transformer and the widths of microstrip lines were calculated and are given in table[3].

Table 3:Impedance matching calculations for metamaterial loaded patch antenna array

Parameters	Values
R_{in}	55.16ohm
Z_1	74.269ohm
Z_2	70.71ohm
$Width_{Z_1}$	2.49mm
$Width_{Z_2}$	2.1mm
$Width_{100ohm}$	1.07mm
$Width_{50ohm}$	5.6mm

2, 4, 8- elements arrays of metamaterial loaded antenna

2-elements array:

From **fig.18** it is seen that two single key antennas have been fed by 50-ohm transmission line. Usually the same substrate is used for both transmission line and antenna. But in this design, FR4 has been used as substrate of transmission line which is different from the key antenna's substrate. Because to keep the ratio of DPS-ENG substrate of key antenna as constant. If DPS has been used as substrate for transmission line, then the ratio of DPS-ENG would not be kept constant anymore which broke main aim of this research. As a result, FR4 has been used from end bottom of key antennas to end of array where the transmission lines were. In addition no substrate has been used in between two key antennas and kept empty.

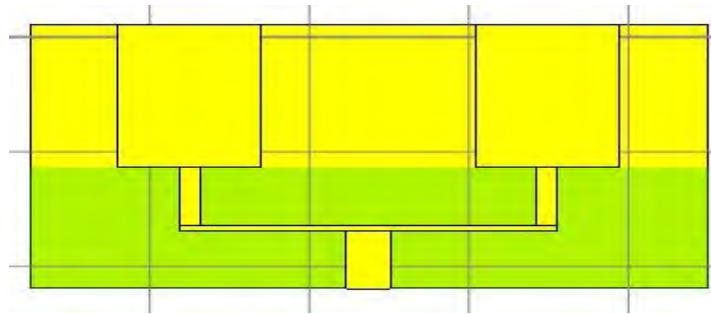

Figure 18: 2-element metamaterial array

The radiation pattern for 2-elements array is shown by **fig.19** where it is found that the gain of the array is 0.709dB which is less than key antenna gain. The angular width is 89.3 degree which means radiation with less directivity. Moreover, it is broadside and omnidirectional.

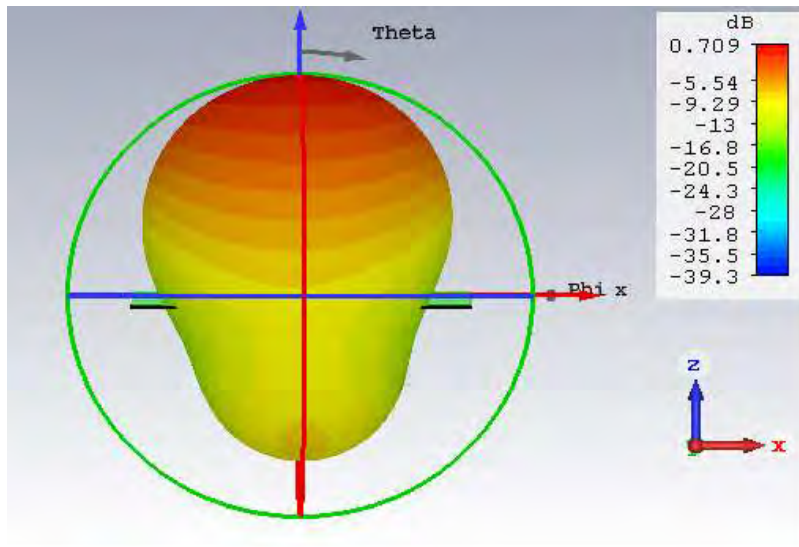

Figure 19: Radiation pattern of 2-elements array

As shown of fig.20, it is observed that the return loss at 2.41GHz is -9.35dB which is less than -10dB. As a result, most of the radiated power is wasted. Furthermore, the resonance frequency has shifted left from the expected resonance frequency, which is undesired.

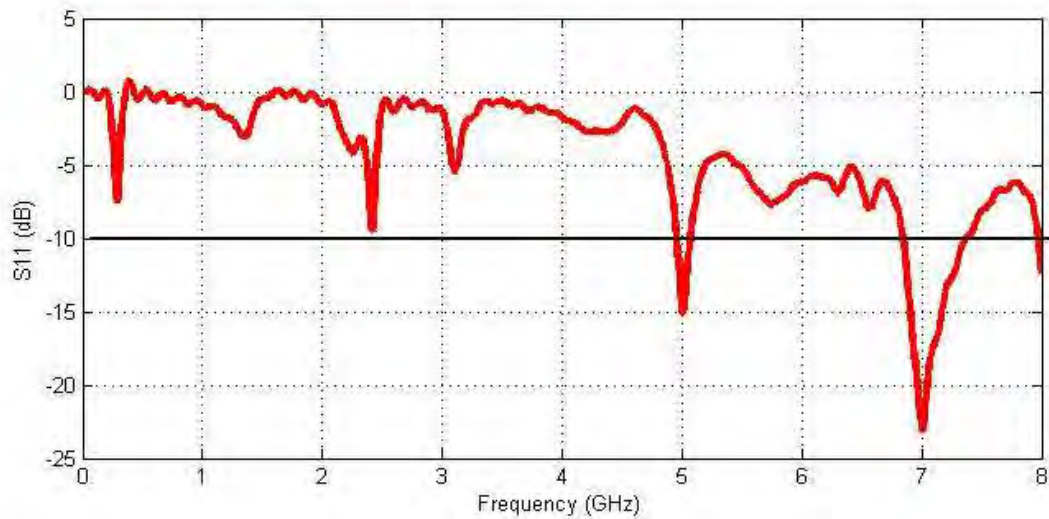

Figure 20: S-parameter of 2-elements array

4-elements array:

4-elements array is same as 2-elements array, here only difference is another two more key antennas have been added (shown in **fig.21**). Basically, two 2-elements array have been connected by a 100 ohm transmission line. And also quarter-wave transmission technique has been used to match impedance between 50ohm transmission lines come out from 2-elements array and 100-ohm transmission line. Finally, one 50-ohm transmission line is fed into 100-ohm transmission line.



Figure 21: 4-elements metamaterial array

From radiation of 4-elements array (**fig.22**), it is noticed that gain is 6.98dB at 3.07GHz. Furthermore, it is more directive as the number of key elements has increased. The radiation pattern is broadside with 5 degree deviation of main lobe.

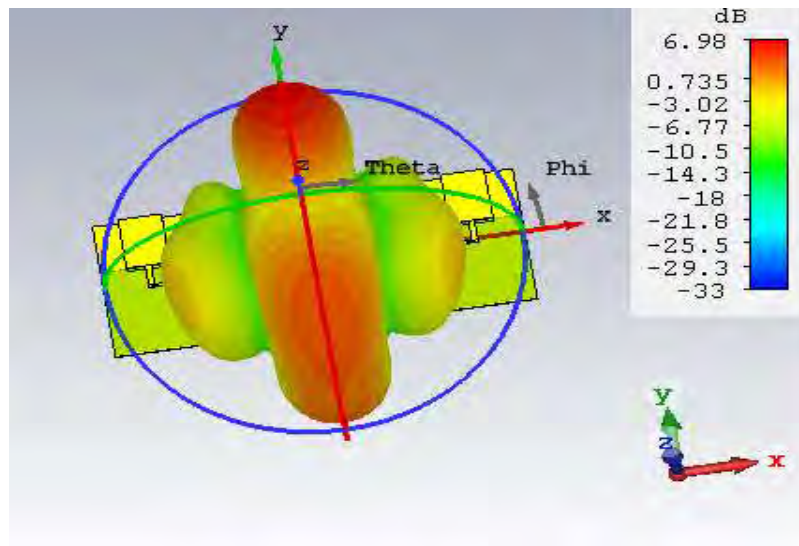

Figure 22: Radiation pattern of 4-element array of metamaterial loaded

Fig.23 of S-parameter for 4-elements array has shown that though resonance frequency has shifted right from desired resonance frequency (2.82GHz), a very good return loss -21dB is got at 3.05GHz.

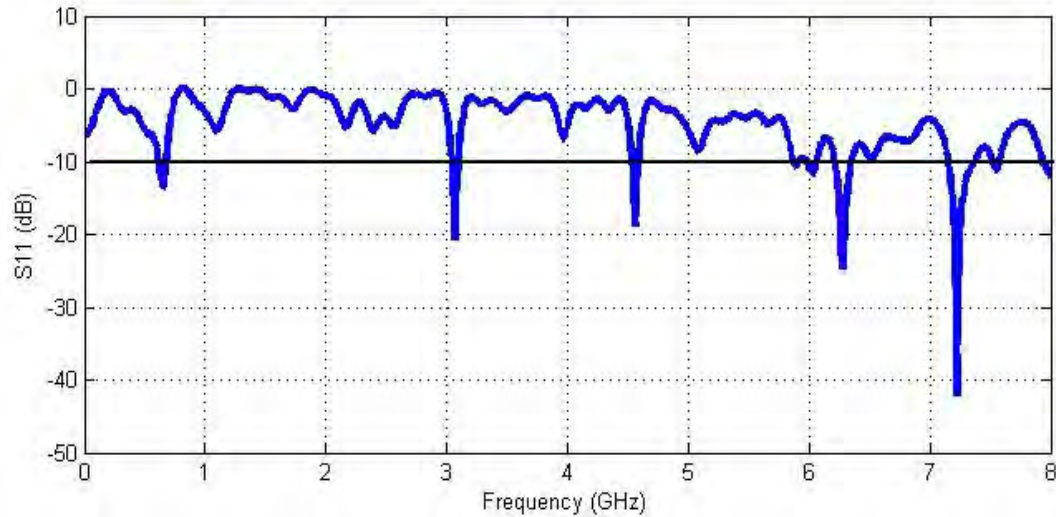

Figure 23: S-parameter of 4-element metamaterial array

8-elements array:

Basically, 8-elements array is combined of two 4-elements array. In this design (**fig.24**), mainly a 100-ohm transmission line has been used to connect two 4-elements arrays and quarter-wave transmission technique is used to match impedance between 100-ohm transmission line and 50-ohm transmission line appear from two 4-elements array. Finally, one 50-ohm transmission line has been used to feed the whole array. And also FR4 has been used as substrate of transmission line and kept free the space between antennas; no substrate has been used.

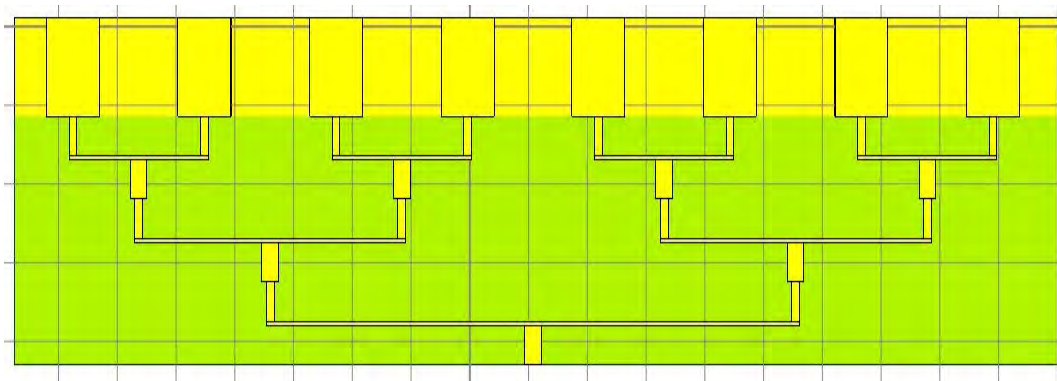

Figure 24: 8-elements array

From **fig.25**, it is found that a desired gain 9.67dB is got at resonance frequency of 3.07GHz. This radiation pattern has more directivity with angular width of 74.9 degree and broadside radiation with 8 degree deviation of main lobe.

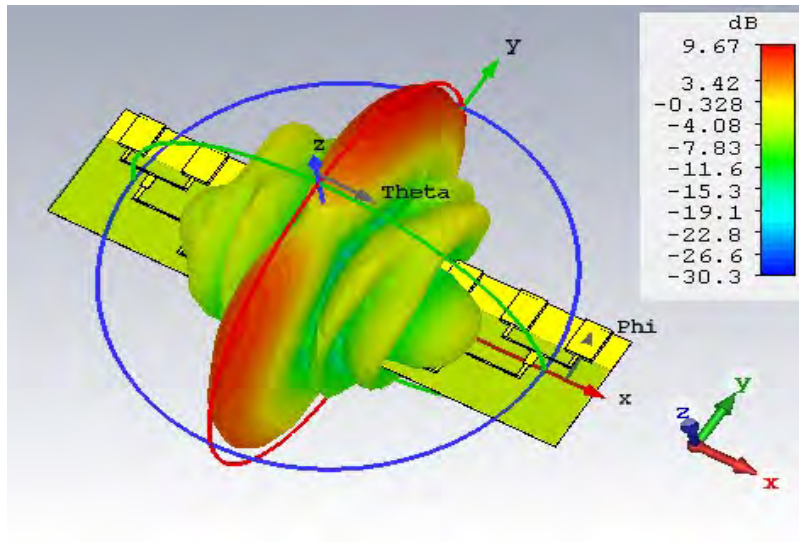

Figure 25: Radiation pattern of 8-elements metamaterial loaded array

From **fig.26**, it is observed that several return-losses have been found before desired resonance frequency of 2.82GHz. And a good return-loss -12 dB is found at 3.05GHz near to desired resonance frequency. Unexpected resonance frequencies will be removed by using filter.

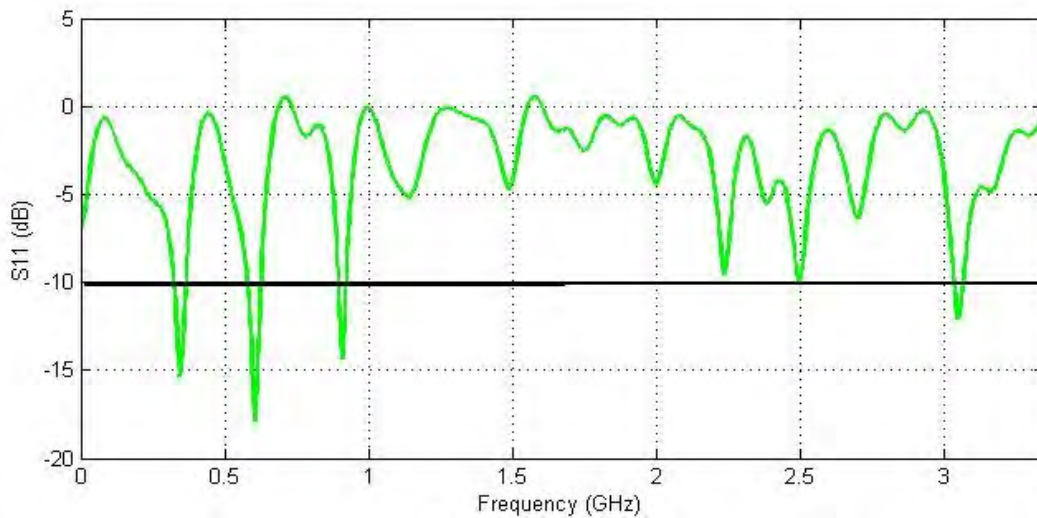

Figure 26: S-parameter of 8-elements metamaterial loaded array

Analysing the results of metamaterial loaded arrays:

These metamaterial loaded microstrip patch antennas were arranged in arrays of 2, 4, and 8 elements. From **fig.27** it can be observed that the return loss increases beyond -10 dB when the number of elements increases but there are several resonances that occur before the desired resonance frequency of 2.8GHz. From table[4], the resonance frequency increases slightly with more elements but is still within the acceptable operating frequency range. The gain increases significantly, with an 8-element array having a gain of 9.67dB. Also, the angular width within 3dB of the radiation pattern decreases, and so, directivity increases in an 8-element array. Observing S-parameter it is found that when the number of key antennas has been increased several, some several unwanted resonance occurred before desired resonance frequency of 2.82GHz. To remove this unwanted resonance, high pass filter will be used.

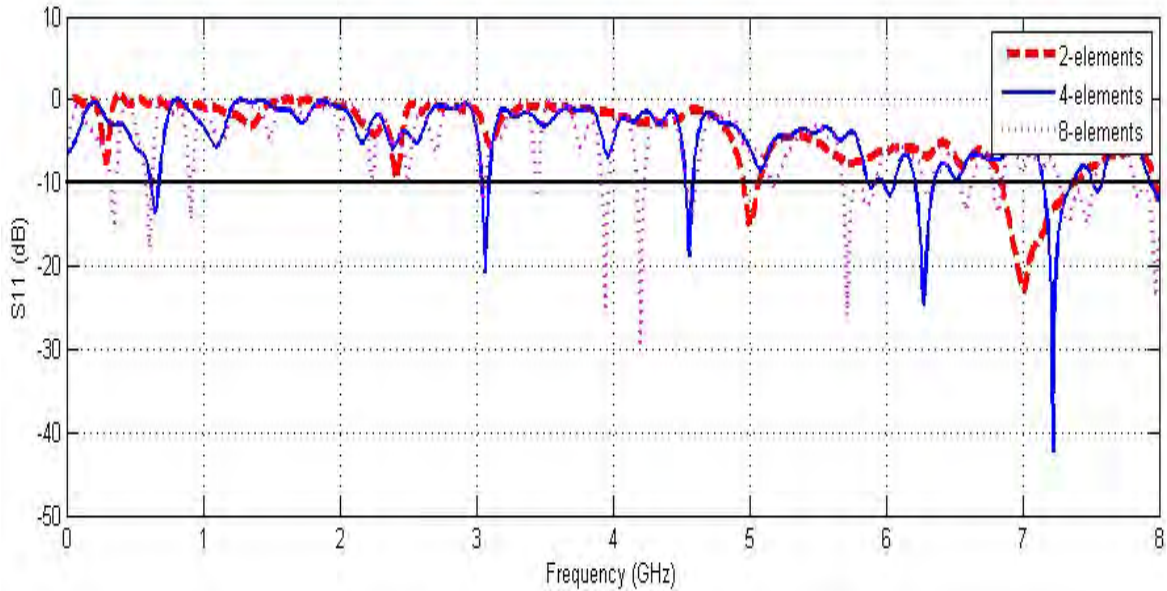

Figure 27: S-parameter of 2, 4, 8 elements array of metamaterial loaded antenna

The angular width has been decreased with increasing of key antennas. For 2-elements array the angular width is 89.3 degree, where this value for 4-elements and 8-elements are 82.9 and 74.9 respectively. Though the directivity has been increased with the increasing of key antennas, the side lobe is also increased. However, radiation has been occurred in yz-plane(**fig.28**) for 8-elements array where it has been occurred in xy-plane for 2-elements and 4-elements array.

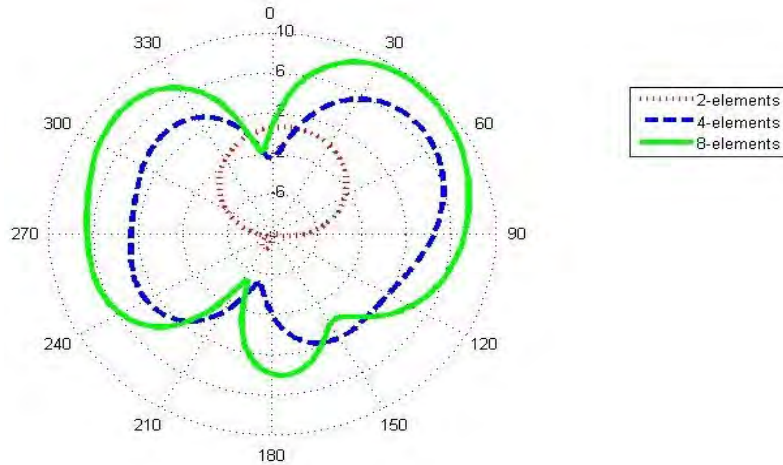

Figure 28: Cross-section of radiation pattern along yz-plane

All simulated results of metamaterial loaded arrays have been given table (4) below:

Table 4:Simulation results for metamaterial loaded array

Number of elements	Resonance Frequency(GHz)	Gain(dB)	Main direction(deg)	Angular width(deg)
2	2.41	0.71	8	89.3
4	3.07	6.98	5	82.9
8	3.05	9.67	8	74.9

6.2 Conventional Microstrip Array

To compare the results of the metamaterial loaded microstrip patch antenna array with a conventional patch antenna, more designs were simulated with FR-4 as the substrate: one group with the same resonance frequency and another with the same dimensions as the metamaterial loaded microstrip antenna.

i. Dimension change:

For this regular 2,4,8-elements array design, the dimension of key antenna is calculated by using desired resonance frequency of 2.82GHz. To calculate the dimension of regular microstrip antenna, previously provided equations (1), (2) have been used and given in the table[5]. FR4 has been used as substrate for both antenna and microstrip transmission line. Here the key antenna's height is used as 1.6mm where it was 3 mm for metamaterial loaded key antenna. Because in the real world, 0.8mm and 1.6mm heights are being used for FR4 as substrate. The width of dimension changed regular antenna is almost double compare to metamaterial loaded key antenna.

Table 5: Parameters of patch antenna with dimension change

Parameter	Values
Length	25.42mm
Width	32.89mm
Height (substrate)	1.6mm
ϵ of FR4	4.3
μ of FR4	1
Resonance frequency	2.8GHz

Using the equations provided in earlier (7), (8), (9) and (10), the impedances of quarter wavelength transformer and the widths of microstrip lines were calculated and are given in table[6].

Table 6: Impedance matching calculations for FR4 loaded with dimension change antenna array

Parameters	Values
R_{in}	65.15ohm
Z_1	80.71ohm
Z_2	70.71ohm
$Width_{Z_1}$	1.25mm
$Width_{Z_2}$	1.64mm
$Width_{100ohm}$	0.723mm
$Width_{50ohm}$	3.14mm

2,4,8-elements arrays of dimension changed loaded antenna

2-elements array:

In 2-elements array, two dimension changed key antennas have been arranged(**fig.29**). Here, 100-ohm transmission line has been used to connect two regular microstrip antennas. Finally, a 50-ohm transmission line is used to feed the array. FR4 is used as Substrate of both antennas and transmission lines. The array has consumed more space almost double compared to 2-elements array with metamaterial antennas.

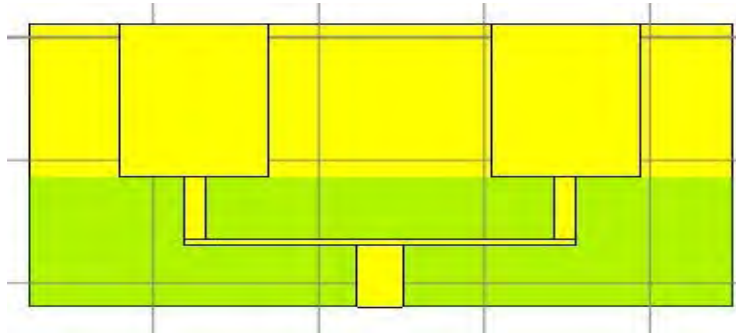

Figure 29: 2-elements array (dimension change)

From **fig.30** it is found that gain of this array is 6.03dB at 2.55GHz .Resonance frequency has been sifted at left compared to desired resonance frequency at 2.82GHz. In addition, radiation pattern is broadside with 9 degree deviation of main lobe. And also it has large angular width of 91.7 degree.

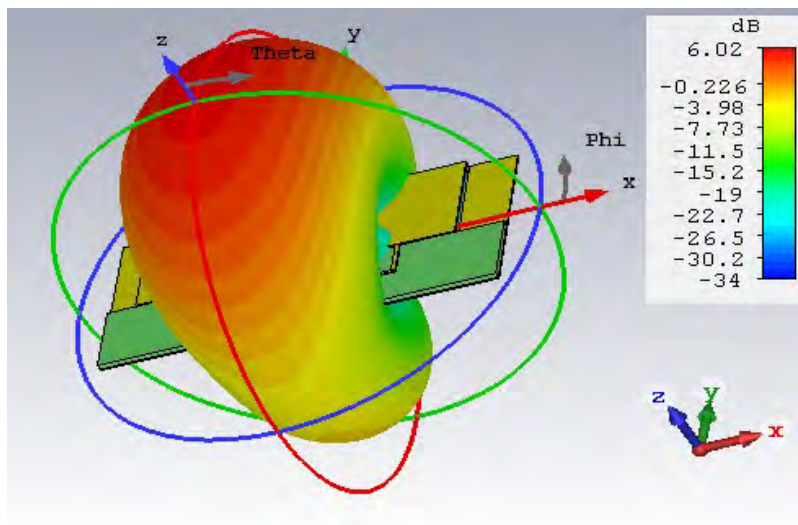

Figure 30:Radiation of 2-element FR4 antenna array with dimension change

4-elements array:

In design of 4-elements array (**fig.31**), a 100-ohm transmission line is used to couple two 2-elements arrays. This design also consumed more space compared to 4-elements array of metamaterial loaded antenna.

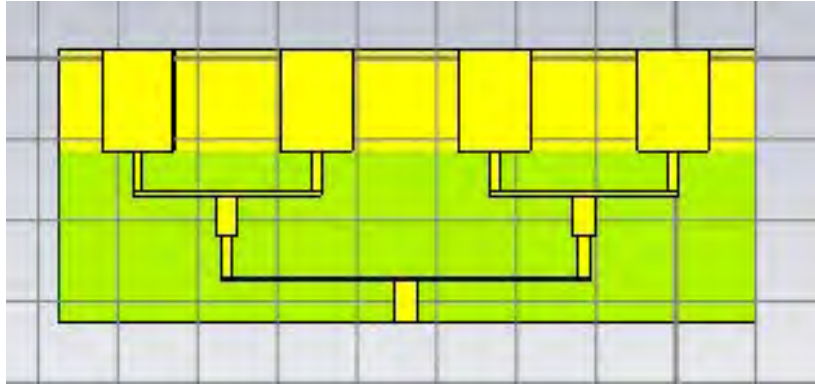

Figure 31:4-elements dimension change antenna loaded array

Fig.32 has shown that gain has been increased (**9.33dB**) and more than 2-elements dimension change loaded antenna array. Furthermore, the resonance frequency for this design has been got at 2.46GHz which is left shifted compared to resonance frequency of 2.82GHz. More importantly, radiation pattern is fully broadside in the xz-plane with no deviation of main lobe. Moreover, side lobe has been increased significantly and the angular width 80.7 degree of this design indicates more directivity of radiation pattern.

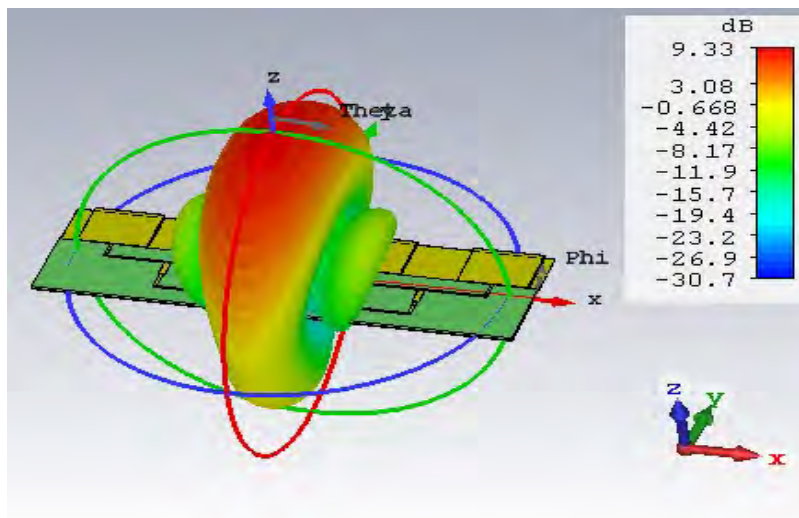

Figure 32: Radiation pattern for dimension changed antenna loaded 4-elements array

8-elements array:

The design shown in **fig.33** is same as 4-elements array where another 4-elements array has been added by 100-ohm transmission line.

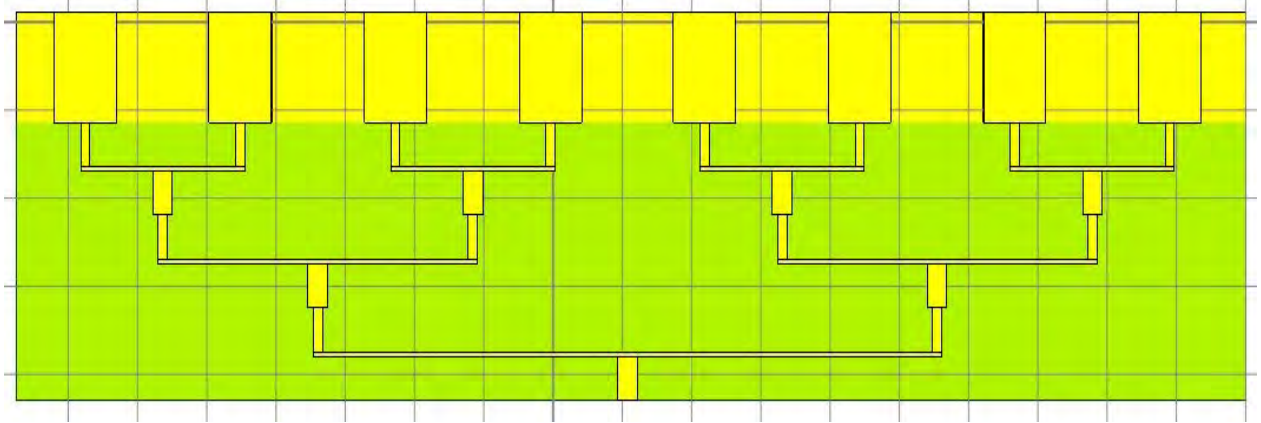

Figure 33: 8-elements dimension changed antenna loaded array

Fig.34 has indicated that gain of 8-elements array of dimension changed loaded antenna at resonance frequency of 2.69GHz is 12.7dB with 11.7 degree angular width. This value of angular width has indicated the extremely directivity of radiation pattern. Though directivity is high compared to others, it has high side lobes also than other designs. Moreover, there is 0 degree deviation of main lobe where radiation pattern is pure broadside.

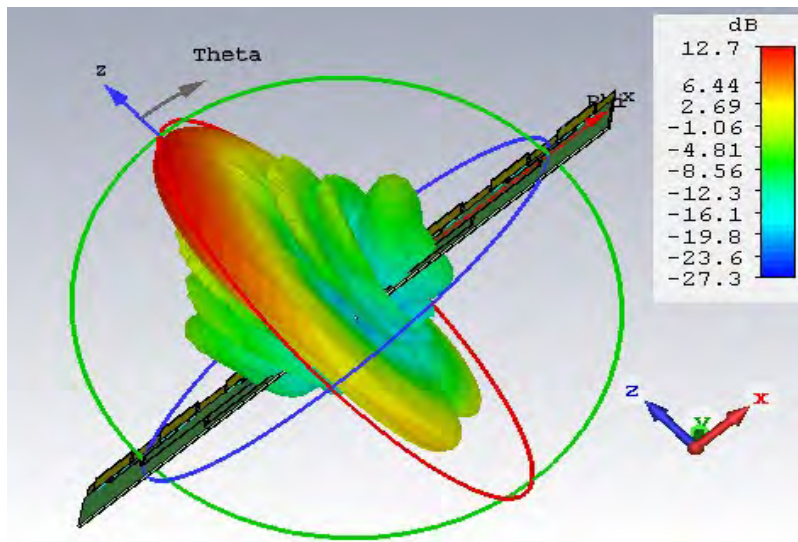

Figure 34: Radiation pattern of 8-elements dimension changed loaded antenna array

Analyzing 2,4,8-elements array using regular microstrip antenna (Dimension Change):

Calculation of the dimensions using resonance frequency at 2.8GHz results in a larger patch antenna. The dimensions and parameters are given in table[5]. The antenna size is nearly doubled so these arrays require more space than the metamaterial arrays. The gain also increases with 8 elements though the side lobes also increase significantly. The radiation pattern given in **fig.35** is in the xz-plane. The deviation of main lobes of 4-elements and 8-elements arrays has been turned in to 0 degree. As a result the radiation pattern of these designs has worked fully in broadside where 2-elements array's radiation pattern has worked in broadside with 9 degree deviation of main lobe. Furthermore, the directivity of the arrays also increases with the increasing number of key antennas (dimension change).

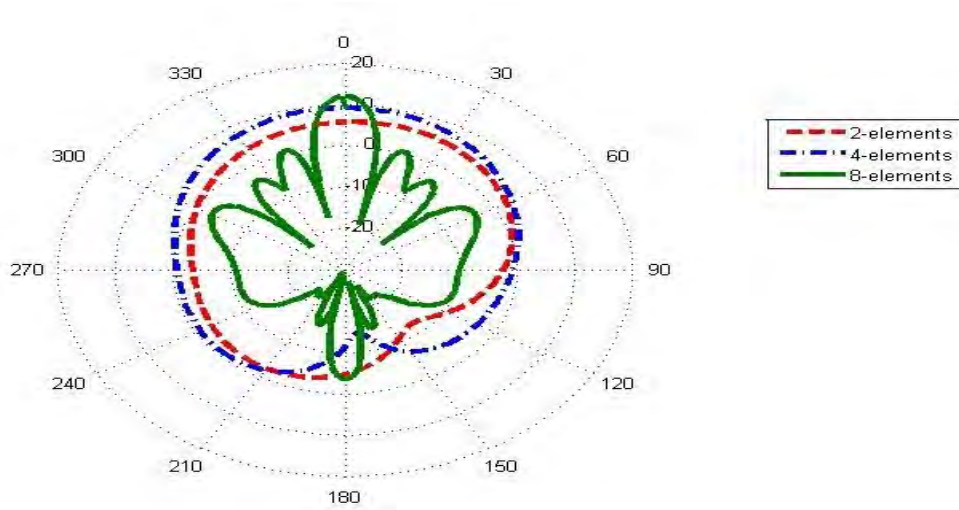

Figure35: Polar radiation pattern of 2, 4, 8-elements FR4 array with dimension change

All resultant values of dimension changed loaded antenna arrays have been given in table [7]:

Table 7: Simulation results for different dimensions array

Number of elements	Resonance frequency(GHz)	Gain(dB)	Main direction(deg)	Angular width(deg)
2	2.55	6.03	9	91.7
4	2.46	9.33	0	80.7
8	2.69	12.1	0	11.7

ii. Same dimensions:

In this design, the dimension of key antenna is same as metamaterial loaded antenna. For both antenna and transmission lines, FR4 is used as substrate. Parameters of single antenna with same dimension are given in table [8] below:

Table 8: Parameters of patch antenna with same dimension

Parameter	Values
Length	25mm
Width	18mm
Height (substrate)	1.6mm
ϵ of FR4	4.3
μ of FR4	1
Resonance frequency(desired)	2.8GHz

After simulation of the same dimension single antenna, the resonance frequency has been got at 2.39GHz. For dimension same antenna of resonance frequency at 2.39GHz, the needed values of impedance matching parameter are calculated by equations (5),(6), (7), (8) and (9) have been given in table [9] below:

Table 9: Impedance matching calculations for FR4 loaded with same dimension antenna array

Parameters	Values
R_{in}	53.813ohm
Z_1	73.36ohm
Z_2	70.71ohm
$Width_{Z_1}$	1.53mm
$Width_{Z_2}$	1.64mm
$Width_{100ohm}$	0.723mm
$Width_{50ohm}$	3.14mm

2,4,8-elements arrays of same dimension loaded antenna

2-elements array:

The arrangement of two antennas in this design is same as other 2-elements arrays design (metamaterial loaded and dimension change). In **fig.36**, the design has been shown.

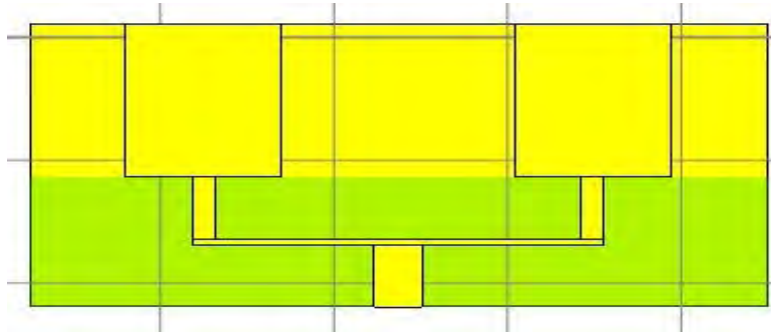

Figure 36:2-elements same dimension loaded antenna array

From **fig.37** of radiation pattern, it could be observed that the resonance frequency at 2.88GHz is 5.2dB. Though the resonance frequency is closed to desired resonance frequency of 2.82GHz, the side lobes are significantly worst. The radiation pattern is broadside with angular width of 89.3 degree. Adding together, main lobe has a little bit deviation of 9 degree.

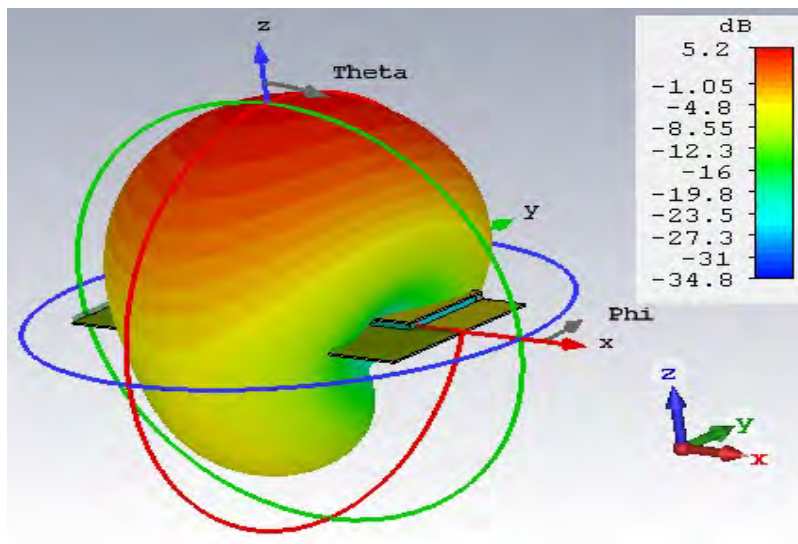

Figure 37:Radiation pattern of 2-elements FR4 antenna array with same dimension

4-elements array:

Though physical arrangement of this design(**fig.38**) is as same as 4-elements metamaterial loaded 4-elements array, the values of width of transmission lines and quarter wave transmissions have been used from table [9].

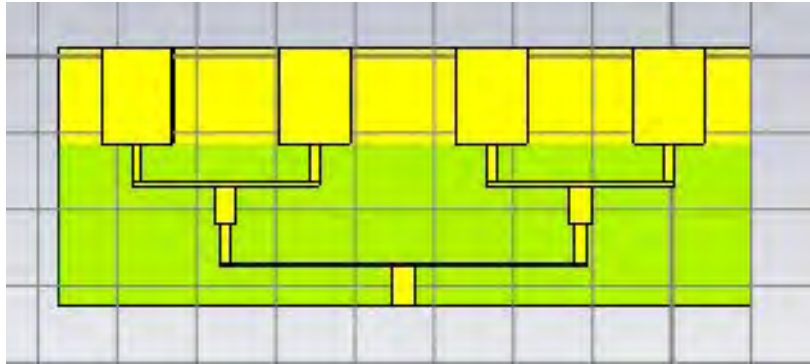

Figure 38: 4-elements same dimension antenna loaded array

The radiation pattern(**fig.39**) has revealed that the gain is 0.95dB at resonance frequency of 2.39GHz. Normally, the gain of array is increased with the increasing the numbers of key antenna. But in this design, the gain of the array has been decreased significantly. Moreover, the resonance frequency also has been sifted in left of desired resonance frequency (2.82GHz).

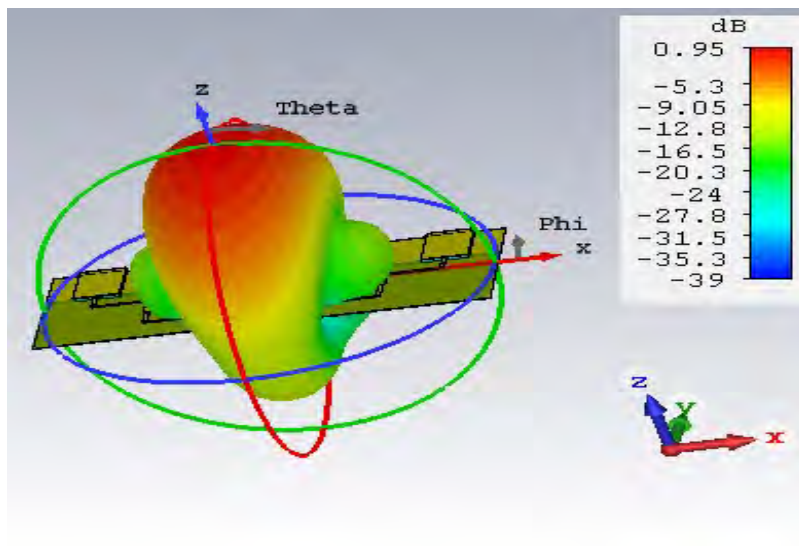

Figure 39: Radiation pattern of 4-elements same dimension antenna loaded array

8-elements array:

Fig.40 has displayed the arrangement of 8 same dimension antennas to make 8-elements array. Two 4- elements same dimension antenna loaded arrays have been combined by a transmission line of 100-ohm which width is 0.723mm. And a 50-ohm transmission line with 3.14mm width has been used to feed the whole array.

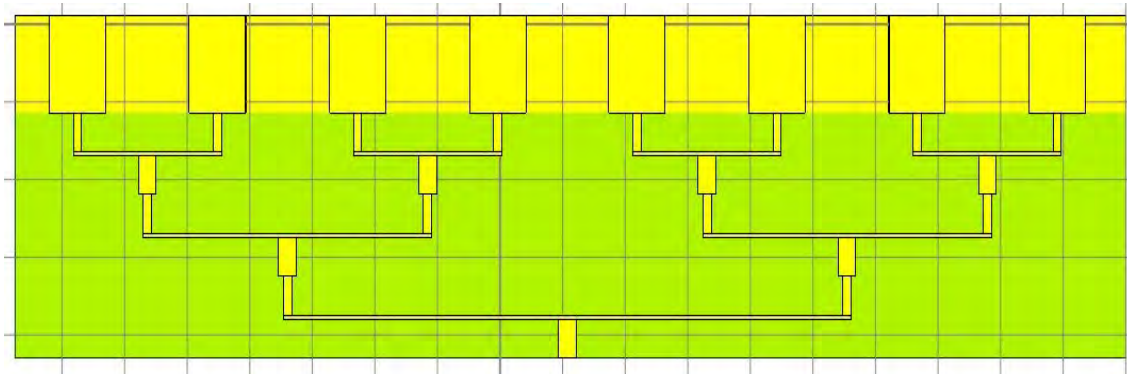

Figure 40: 8-elements same dimension antenna loaded array

Fig.41 has exposed that resonance frequency at 2.39GHz the gain of the array is 2.62dB. According to array theory, gain must be increased with growing the numbers of elements. However, in this design, the gain of the array has been extensively decreased which is unexpected. Besides, resonance frequency of this design has been sifted to left of expected resonance frequency. Over all, the radiation pattern of the 8-elements same dimension antenna loaded array is worst.

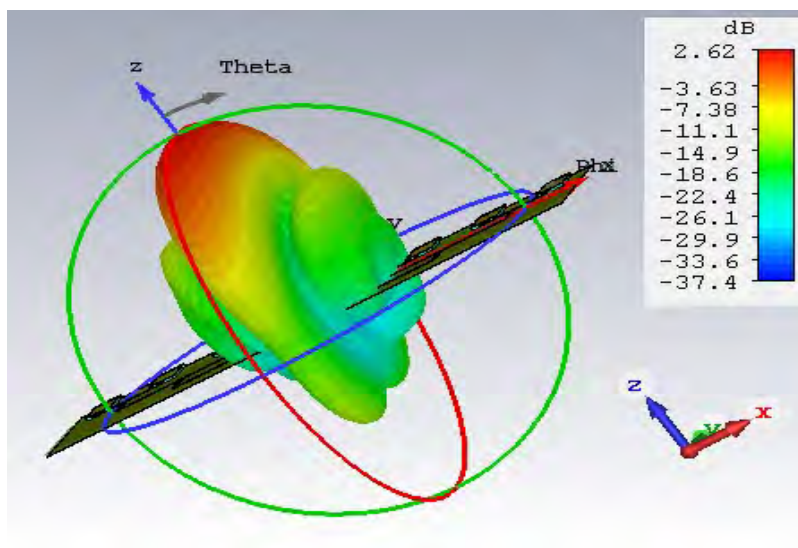

Figure 41: Radiation pattern of 8-elements same dimension loaded antenna array

Analyzing of 2, 4, 8-elements same dimension loaded antenna arrays:

For a patch antenna with the same dimensions, the resonance frequency falls to 2.39 GHz. This design has poor radiation pattern, and gain decreases with an increase of elements. For 2-elements array, the gain is comparatively good than other two designs (4, 8- elements array). From **fig.42**, it has been observed that radiation pattern of 4, 8-elements have been omnidirectional. Though the directivity of the arrays has been increased with the rising of elements, all radiation patterns has been considered to be worst compared to others (metamaterials loaded and dimension change loaded).

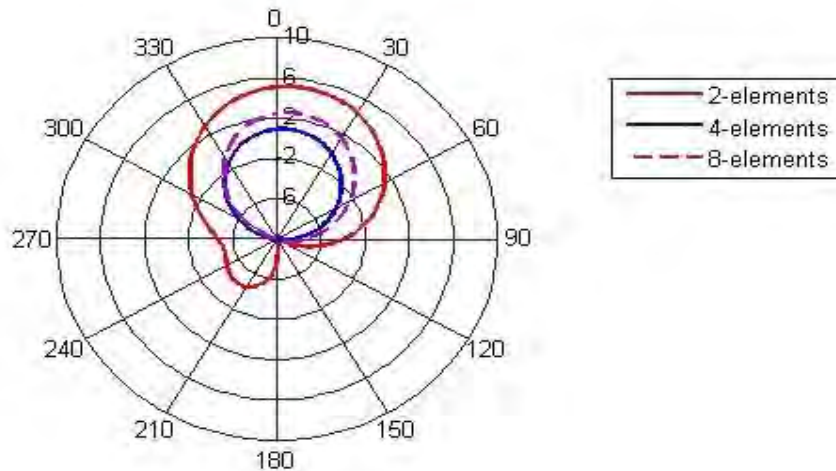

Figure42: Polar radiation pattern of 2, 4, and 8 element arrays for same dimension antenna array

All results of same dimension antenna loaded arrays have been given in table[10] below:

Table 10: Simulated results of all same dimension antenna loaded arrays

Number of elements	Resonance Frequency(GHz)	Gain(dB)	Main direction(deg)	Angular width(deg)
2	2.88	5.12	8	89.3
4	2.39	0.95	5	82.9
8	2.39	2.63	8	74.9

6.3 Comparison

Fig.43 compares the S-parameter of all the 8-element arrays and shows that the metamaterial loaded microstrip patch antenna array has the best S-parameter. The metamaterial array has a good S-parameter value within the desired frequency range. The return loss of the 8-elements metamaterial loaded array is -12dB where return loss of 8-elements same dimension antenna loaded array and 8-elements dimension changed antenna loaded array are -7.35dB and -2.44db respectively. It is known from antenna theory that to get good radiation pattern with good power efficiency, the return loss must be equal or greater than -10dB. Because, if the return loss is less than -10dB, almost 50% power will not transmitted. Maximum power will be wasted. From this point of view, metamaterial loaded arrays will be considered the best compared to others. Besides, the S-parameter for dimension change array shifted beyond the desired resonance frequency of 2.82GHz.

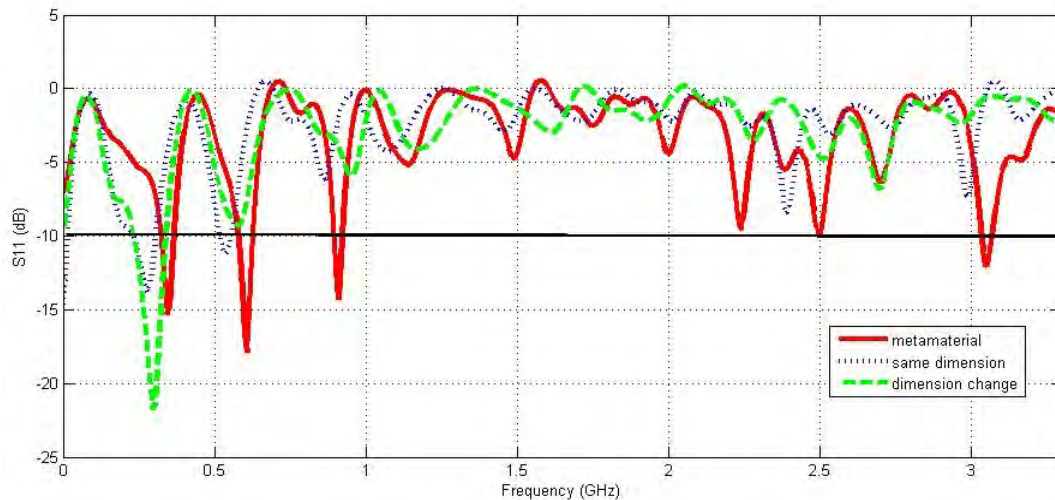

Figure 43: S-parameters of all substrates for 8-elements

From **fig.44**, it is observed that the FR-4 array designed for the same dimensions as the metamaterial loaded microstrip patch antenna performs worse than the other designs when the number of elements increases. Though the gain is better for dimension change array, the metamaterial array is nearly half its size. As a result, using the same area used for dimension change array to design a metamaterial loaded array, it can be possible to use double numbers

of metamaterial loaded single key antennas. In this way, this design will increase the gain of the metamaterial loaded array compared to the gain of dimension change loaded array.

Furthermore, the radiation planes are different- metamaterial radiates in the yz-plane and the others radiate in the xz-plane. Though the radiation pattern of dimension change is yz-plane, it wastes maximum power where the metamaterial loaded array radiates power with desired value.

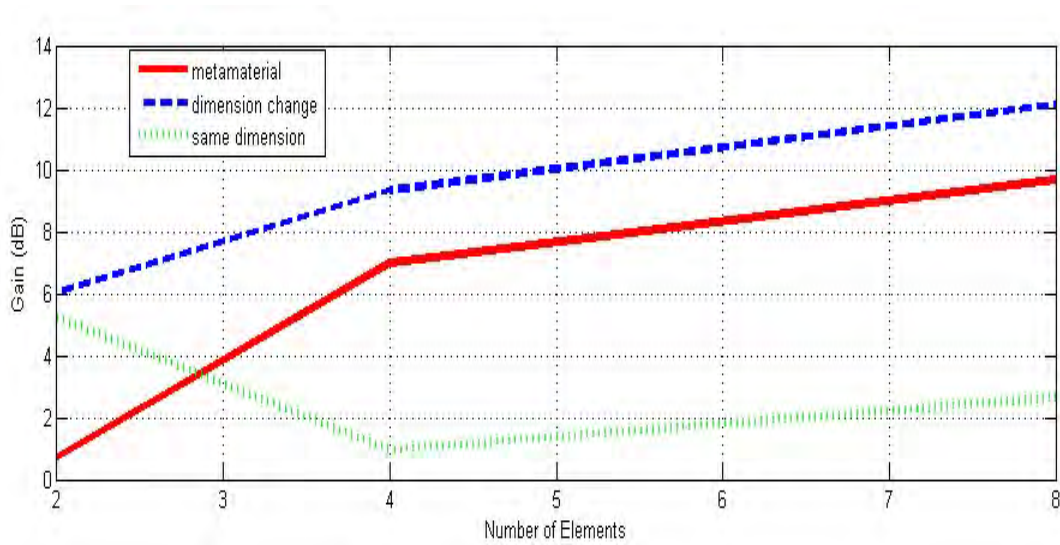

Figure 44: Comparison of gain versus number of elements for all arrays

6.4 Difficulties in Feeding Techniques

In this research, different types of feeding techniques have been applied. At the beginning the coaxial feed method was applied. But using this feeding technique, desired results did not get. Then another popular feeding technique aperture feed technique has been tested. And also by this feed technique, expected results could not be achieved. The problems regarding these feed techniques have been explained below:

i. Coaxial feed:

To apply coaxial feed technique, necessary parameters were calculated by using equations (5), (6),(7) and (10) given in table [11] below:

Table 11: Calculation for coaxial fed 2-element array

Parameter	Value
Antenna length	25mm
Antenna width	18mm
R_{in}	357.488ohm
Z_1	189.07ohm
Width of Z_1	0.063mm
Width of 100ohm	1.07mm
Width of 50ohm	5.6mm

Initially, a 2-element array was designed using a coaxial feeding line. Though the S-parameter for it is good(**fig.45**), it could not be accepted as the feeding line width is much smaller than 0.25mm.

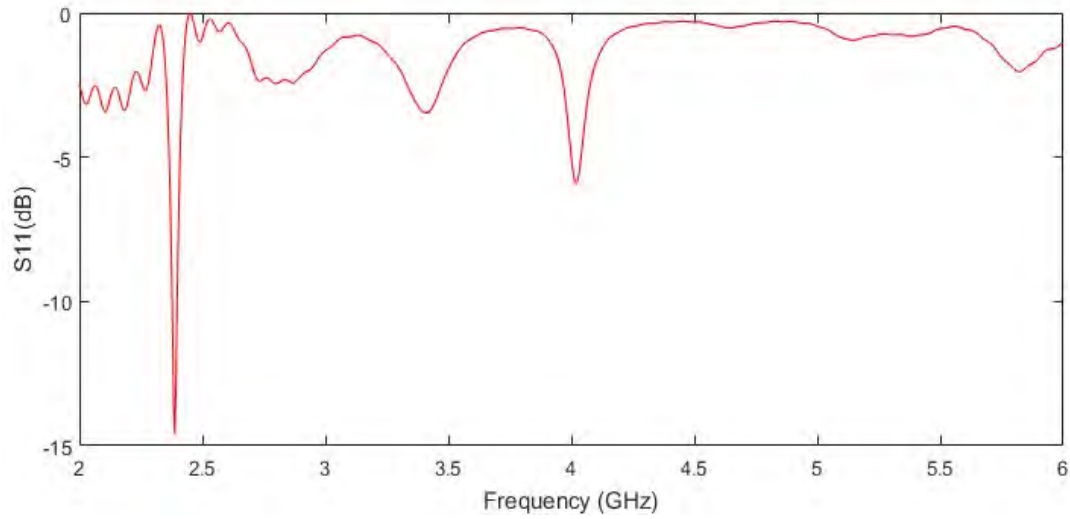

Figure 45: S-parameter for coaxial fed array

As the microstrip is too narrow(**fig.46, 47**), the patch does not get the amount of current needed to radiate. Moreover, the shape of the coaxial line and the rectangular microstrip are different and this restricts current flow even further. The coaxial line was drilled into the substrate, which has a negative effect on radiation pattern and decreases bandwidth. Due to these complications, no more designs were done by following this feeding.

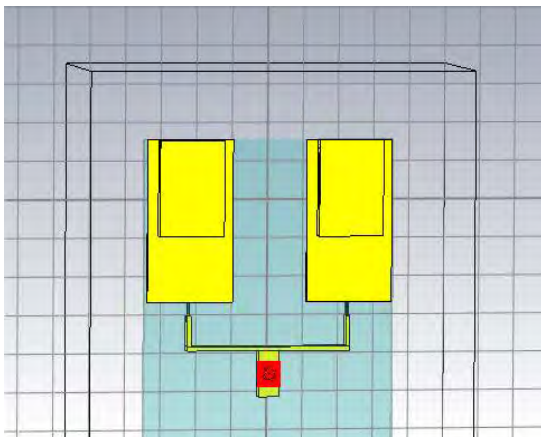

Figure 46: Front view of coaxial fed array

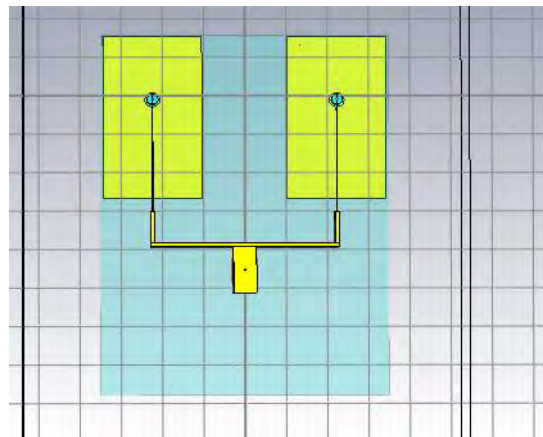

Figure 47: Back view of coaxial fed array

Fig.48 has revealed that a strong electric field has been created at transmission lines where electric field of key antennas was very much weak. Due to insufficient current flow, no effective electric field has been created. Thus power could not be radiated by antenna.

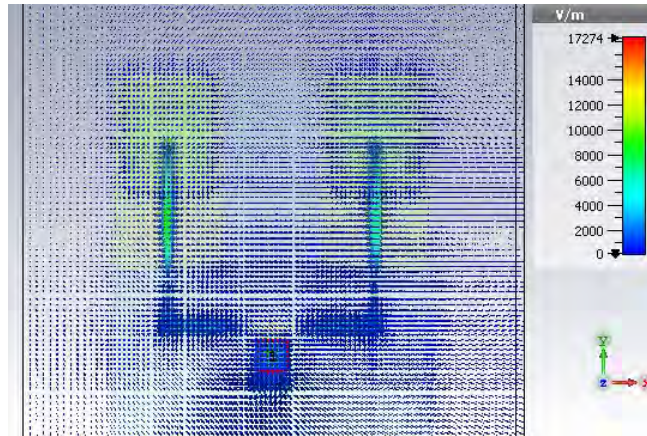

Figure48: Electric field view for coaxial fed array

From **fig.49**, it is found that the radiation pattern is worst as antennas did not get enough current to create electric field. As a result antennas could not radiate power which is wasted.

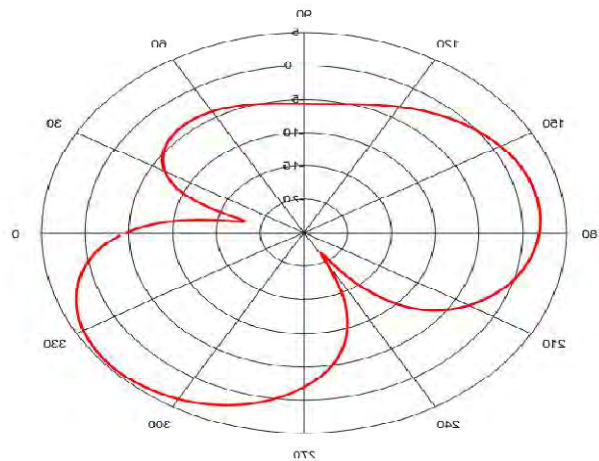

Figure 49: Radiation pattern of coaxial fed array

ii. Aperture feeding:

Another feeding technique was attempted called aperture feeding. Basically it is consisted of two different substrates which are separated by a ground. This technique is popular as easy to match impedance. The thick substrate with low dielectric places on top and thin substrate with high dielectric places at bottom. Energy of feed line is coupled through a slot on the ground plane.

The measurements for calculation of width of feed line were done by equations (5),(6),(7)and(8) given table [12] below:

Table 12: Calculation for aperture fed of 2-element array

Parameter	Value
Antenna length	25mm
Antenna width	18mm
R_{in}	357.488ohm
Z_1	189.07ohm
Width of Z_1	0.5mm
Width of 100ohm	1.07mm
Width of 50ohm	5.6mm
h_1	5mm
h_2	14.5mm

Fig.50 has shown that the feed lines are in the substrate. A coaxial line out from key antenna is connected to feed lines.

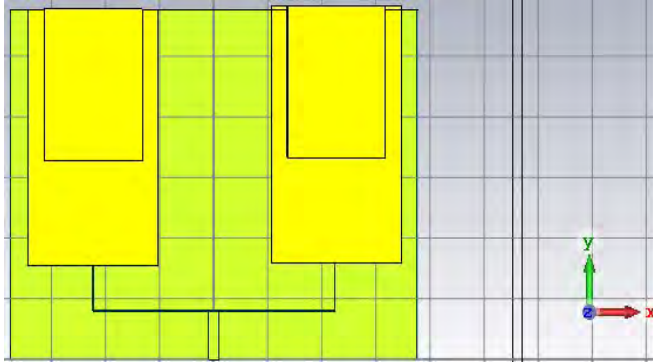
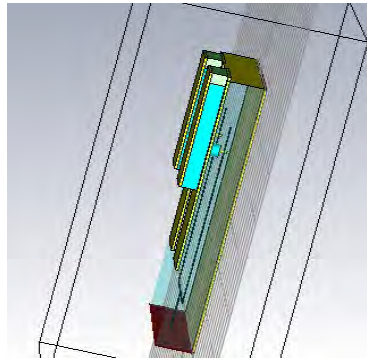

Figure 50: Front view of aperture fed array

Figure 51: Side view of aperture fed array

From **fig.52**, it can be seen that return loss at resonance frequency of 2.7GHz is -27.86dB which is very good as it is greater than -10dB. There is another return loss greater than -10dB is found at 2.55GHz.

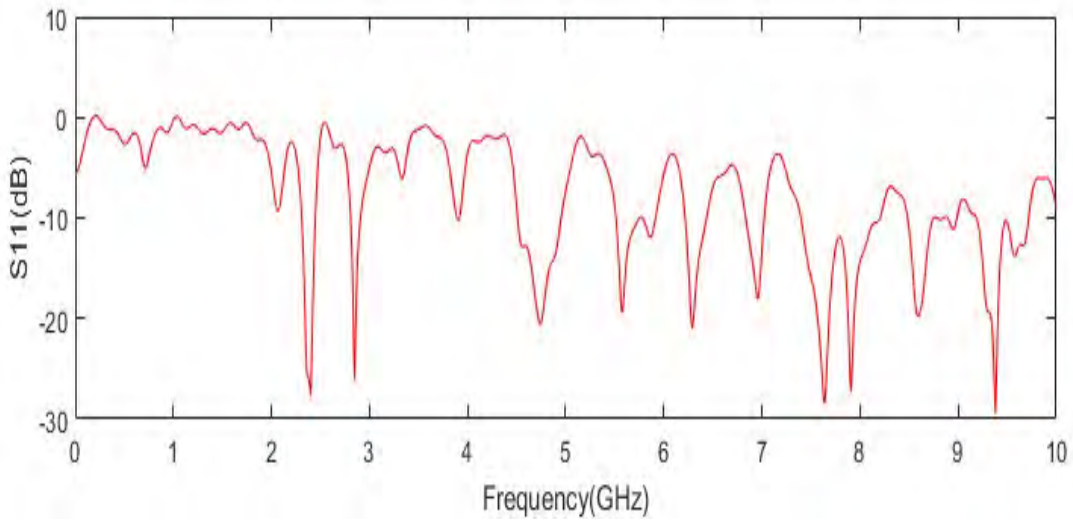

Figure 52: S-parameter for aperture feeding

Fig.53 has shown that the gain of the array is 7.2dB. Though the gain is good, this gain is appeared for the radiation pattern of transmission lines. Here the transmission lines have been considered as primary radiator and the antennas have considered as secondary.

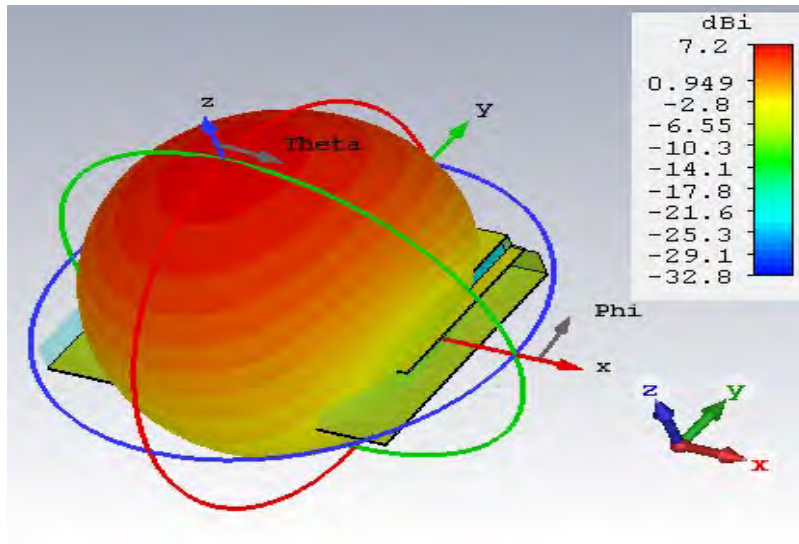

Figure 53: Radiation pattern of aperture fed array

From fig.54, it can be seen that there was no current passed to the antenna. This was due to the mismatch between the coaxial line and the microstrip feed line. The difference in shape led to no current flowing through the array. It resulted in only the feeding line having a radiation pattern instead of the patch. This feeding technique was also dismissed due to these complications.

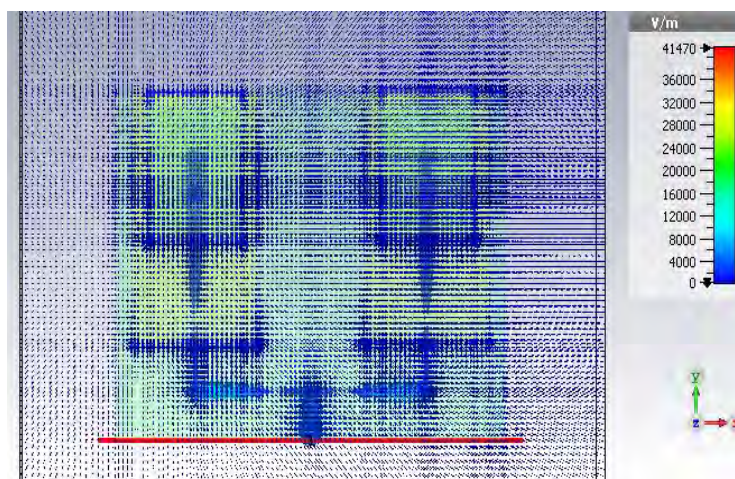

Figure54: Electric field view for aperture feeding

7. Future work

The designed metamaterial loaded patch antenna has a significantly smaller size than the conventional rectangular patch antenna without much loss in gain. Further research can lead to even smaller antennas by experimenting with different permittivity values, feeding methods, impedance matching techniques, etc.

All the antenna arrays in this thesis were created using a DPS-ENG combined substrate. In the future, a DPS-MNG substrate can also be used to compare the results and observe the way it differs from a DPS-ENG substrate antenna array.

Another way to continue this work could be to shift the radiation pattern of the metamaterial loaded microstrip rectangular patch antenna from broadside to endfire radiation. Then the antennas in an array could be placed perpendicularly and maximize the space utilized. Additional antennas could be added in the space saved to also maximize gain.

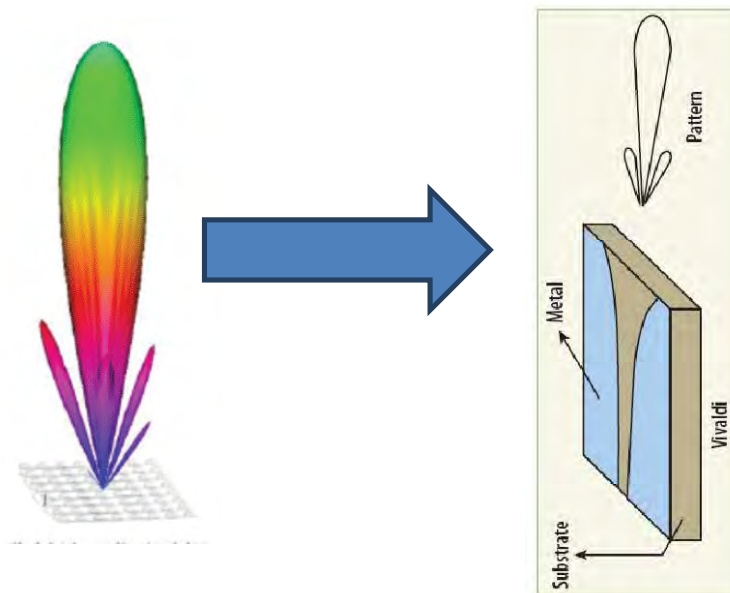

Figure 55: Shifting radiation pattern in the future

8. Conclusion

In this thesis, a metamaterial loaded microstrip patch antenna array was designed, consisting of a DPS-ENG substrate. A microstrip was used to connect the antenna elements together and to the feed line. Quarter-wavelength transformer was used for impedance matching. The metamaterial substrate causes miniaturization of the antenna while still receiving the same frequency and it is a good compromise between size and gain compared to a normal antenna. A rectangular patch antenna array made of a FR4 substrate, designed to have the same resonance frequency as the metamaterial loaded one, experiences better gain but has too many side lobes to be considered efficient. It is also nearly twice the size of the metamaterial loaded one. Considering the increase in wearable technology, and thus the need to make everything smaller, this antenna array is a useful contribution to the field.

As research in metamaterial field is relatively recent, most of the documentation is physics related. Metamaterial as it applies to engineering- more specifically, antennas- is very new and there is ongoing research. There are many different ways of incorporating it in antennas, different types of antennas, feeding techniques etc. that are being investigated by engineers all over the world. Moreover, there is still not much uniformity in calculating parameters for antennas loaded with metamaterial. In the coming years, there will be more innovation as a result of research into this promising field.

References

1. Rao, K. B. (2017). Computer systems architecture vs quantum computer. 2017 International Conference on Intelligent Computing and Control Systems (ICICCS). doi:10.1109/iccons.2017.8250619
2. What is Antenna? - Definition from Techopedia. (n.d.). Retrieved from <https://www.techopedia.com/definition/5041/antenna>
3. Salsburg, J. (n.d.). The Log-Periodic Dipole Array. Retrieved from <http://www.salsburg.com/Log-Periodic.pdf>
4. W2AEE Antenna History. Arthur M. Kay, scanned by Alan Crosswell. <http://www.w2aee.columbia.edu/history/antenna-history.html>
5. Different types of antennas with properties and their working. (n.d.). Retrieved from <https://www.elprocus.com/different-types-of-antennas-with-properties-and-thier-working/>
6. "Dipole Antennal". Resources. Radio-Electronics.com. Adrio Communications, Ltd. 2011. Retrieved July 3, 2018.
7. Weiner, Melvin M. Weiner (2003). Monopole antennas. USA: CRC Press.
8. Magnetic receiving loops". w8ji.com.Revised June 13 2006
9. C. A. Balanis, "Antenna theory: analysis and design. Hoboken", NJ: Wiley Interscience, 2005.
10. Balanis, Constantine. "Antenna Theory: A Review", Proceedings of the IEEE, vol. 80, January 1992.
11. I. J. Bahl and P. Bhatia, "Microstrip Antennas". Artech House, Dedham, MA, 1980. [12] IE3D User Manual, Zealand Software
12. E. O. Hammerstad, "Equation for Microstrip Circuit Design", Proc. Fifth European Microwave conference, pp. 268-272, September 1975.
13. C. A. Balanis, "Advanced Engineering Electromagnetics", John Wiley and Sons, New York, 1989.
14. Bevelacqua, Peter (2016). "Array Antennas". Antenna-theory.com. Retrieved July 2, 2018.
15. Kshetrimayum, R. S. (2004). "A Brief Intro to Metamaterials". IEEE Potentials. 23 (5): 44–46.
16. Zouhdi, Saïd; Ari Sihvola; Alexey P. Vinogradov (December 2008). Metamaterials and Plasmonics: Fundamentals, Modelling, Applications. New York: Springer-Verlag. pp. 3–10, Chap. 3, 106.
17. Slyusar V.I. Metamaterials on antenna solutions. 7th International Conference on Antenna Theory and Techniques ICATT'09, Lviv, Ukraine, October 6–9 2009. pp. 19–24
18. Veselago, V. G. (1968) [Russian text 1967]. "The electrodynamics of substances with simultaneously negative values of ϵ and μ ". Sov. Phys. Usp. 10 (4): 509–14.

19. AIP News, Number 628 #1, March 13 Physics Today, May 2003, Press conference at APS March Meeting, Austin, Texas, March 4, 2003, New Scientist, v. 177, p. 24.
20. Engheta, N. and Ziolkowski, R. (2006). "Metamaterials" Piscataway: IEEE Press.
21. Peixeiro, C., Microstrip patch antennas: An historical perspective of the development, Microwave & Optoelectronics Conference (IMOC), 2011 SBMO/IEEE MTT-S International , pp.684-688, Oct. 29 2011-Nov. 1 (2011).
22. M. R. C. Mahdy, M. R. A. Zuboraj, A. A. N. Ovi, and M. A. Matin "An Idea of Additional Modified Modes in Rectangular Patch Antennas Loaded With Metamaterial", I Antennas and Wireless Propagation Letters, vol. 10, pp. 869872, 2011.
23. Santillán-Haro, D., Antonino-Daviu, E., Sánchez-Escuderos, D. and Ferrando-Bataller, M. (2018). Analysis and Design of a Metamaterial Lens Antenna Using the Theory of Characteristic Modes. *International Journal of Antennas and Propagation*, 2018, pp.1-8.
24. F. Zhu, Q. Lin, J. A. Hu, "A directive patch antenna with a metamaterial cover", *IEEE APMC Proc.*, 2005.
25. M. R. C. Mahdy, M. R. A. Zuboraj, A. A. N. Ovi, and M. A. Matin, "A Novel Design Algorithm' and Practical Realization of Rectangular Patch Antenna Loaded with SngMetamaterial," *Progress In Electromagnetics Research M*, Vol. 17, 13-27, 2011. doi:10.2528/PIERM10112006
26. Nahiyan, S., Maruf, A., Mahdy, M.R., Sagor, M.H., "Modification of Higher Order Natural Mode in Metamaterial Loaded Patch Antenna", *Proceedings of IET Microwaves, Antennas & Propagation (Submitted)*
27. Ahmed, S. K., Chandra, M., &Kadhim, H. A. (2016). Cross Polarization Discrimination Enhancement of a Dual Linear Polarization Antenna Using Metamaterials. 2016 UKSim-AMSS 18th International Conference on Computer Modelling and Simulation (UKSim). doi:10.1109/uksim.2016.14
28. Akcelik, H., Yucedag, O. M., Torun, E., &Kocer, H. (2015). A metamaterial based broadband microstrip antenna. 2015 9th International Conference on Electrical and Electronics Engineering (ELECO). doi:10.1109/eleco.2015.7394530
29. Zani, M., Jusoh, M. H., Sulaiman, A. A., Baba, N. H., Awang, R. A., &Ain, M. F. (2010). Circular patch antenna on metamaterial. 2010 International Conference on Electronic Devices, Systems and Applications. doi:10.1109/icedsa.2010.5503053
30. James, J. R., Hall, P. S., and Wood, C., —Microstrip Antenna: Theory and Design,|| *IEEE electromagnetic Waves*, Series 12 5. (London: Peter Peregrinus), 1986.
31. Balanis, Constantine A. (1982). *Antenna Theory*. John Wiley & Sons. p. 164
32. Parimi, P. V.; Lu, W. T.; Vodo, P; Sridhar, S (2003). "Photonic crystals: Imaging by flat lens using negative refraction
33. Caloz, C.; Chang, C.-C.; Itoh, T. (2001). "Full-wave verification of the fundamental properties of left-handed materials in waveguide configurations

34. Eleftheriades, G.V.; Iyer A.K. & Kremer, P.C. (2002). "Planar Negative Refractive Index Media Using Periodically L-C Loaded Transmission Lines". IEEE Transactions on Microwave Theory and Techniques
35. Wiltshire, M., Hajnal, J., Pendry, J., Edwards, D. and Stevens, C. (200). "Metamaterial endoscope for magnetic field transfer: near field imaging with magnetic wires." Optics Express, 11(7), p.709.
36. R. W. Ziolkowski and A. Kipple, "Causality and double-negative metamaterials, "Phy.7. Rev. E, vol. 68, 026615. Aug. 2003.
37. Nader Engheta and R.W. Ziolkowski "Metamaterials Physics and Engineering Explorations", IEEE Press Wiley Interscience, 200.
38. J.A. Kong, "Electromagnetic Wave Theory", John Wiley Sons, New York, 198.
39. R. Marques, F. Medina, and R. Rafii-El-Idrissi, "Role of anisotropy in negative permeability and left-handed metamaterials", Phys. Rev. B, vol. 5, pp. 1–6, 2002
40. A. Alu and N. Engheta, "Distributed-circuit-element description of guided-wave Shifted Radiation Pattern of Microstrip Antenna with Metamaterial Structures and cavities involving double-negative or single-negative media", in Proceedings of the SPIE Annual Meeting 2003 , Complex Mediums IV: Beyond Linear Isotropic Dielectrics , vol. 5218, San Diego, CA, August 3–8, 2003, pp. 145–155.
41. K. R. Carver and J. W. Mink, "Microstrip antenna technology", IEEE Trans. Antennas Propag. , vol. AP-29, no. 1, pp. 2–24, Jan. 1981
42. W. F. Richards, Y. T. Lo, and D. D. Harrison, "An improved theory of microstrip antennas with applications", IEEE Trans. Antennas Propag. , vol. AP-29, no. 1, pp. 34–46, Jan. 1981
43. Sailing He, Jiang Xiong, Hui Li and Yi Jin, "Patch Antennas Based on a Pair of DPS and SNG Metamaterial"
44. A. Alu and N. Engheta, "Pairing an epsilon-negative slab with a mu-negative slab: Resonance, tunneling and transparency", IEEE Transactions on Antennas and Propagation, vol. 51, no. 10, pp. 2558-2571, 2003.
45. Alu, A., Engheta, N. (2004). "Guided Modes in a Waveguide Filled With a Pair of Single-Negative (SNG), Double-Negative (DNG), and/or Double-Positive (DPS) Layers.", IEEE Transactions on Microwave Theory and Techniques, 52(1), 199-210
46. Xu, W., Li, L., Yao, Y., Wu, Q. (2005). "Left-handed Material Effects on Waves Modes and Resonant Frequencies: Filled Waveguide Structures and Substrate-Loaded Patch Antennas.", Journal of Electromagnetic Waves and Applications, 19(15), 20
47. Mahdy, M. R., Zuboraj, M. R., Ovi, A. A., Matin, M. A. (2011). "A Novel Design Algorithm And Practical Realization Of Rectangular Patch Antenna Loaded With SNG Metamaterial.", Progress In Electromagnetics Research M, 17, 1 -27.
48. Mahdy, M. R., Zubora, M. R., Ovi, A. A., Matin, M. A. (2011). "Novel Design Of Triple Band Rectangular Patch Antenna Loaded With Metamaterial." Progress In Electromagnetics Research Letters, 21, 99-107.

49. F. Bilotti, A. Toscano, L. Vegni, K. Aydin, K. Boratay, and. Ozbay, “ Equivalent Circuit Models for the Design of Metamaterials Based on Artificial Magnetic Inclusions”, IEEE Transactions on Microwave Theory and Techniques , Vol. 55, no. 12, Dec. 2007
50. Bevelacqua, P. (n.d.). Welcome to Antenna-Theory.com! Retrieved July 15, 2018, from <http://www.antenna-theory.com/>
51. The Basics of Patch Antennas, Orban Microwave. [Online]. Available: <http://orbanmicrowave.com/the-basics-of-patch-antennas/>. Accessed: 15July, 2018.
52. J. R. allas, “Basic antennas: understanding practical antennas and design includes details of easy-to-build antennas” Newington, CT: ARRL, 2008.
53. J. L. Volakis, “Antenna engineering handbook.”, New York: McGraw-Hill, 2007.
54. R. G. Zope and P. A. Nawale, “Design and Improvement of Microstrip Patch Antenna Parameters Using Defected Ground Structure”, Int. Journal of Engineering Research and Applications, vol. 4, no. 6, pp. 123129, Jun. 2014
55. R. Garg, P. Bhartia, I. Bahl, and A. Ittipiboon , “Microstrip Antenna Design Handbook .” Boston, MA: Artech House, 2001
56. Solymar, L., Shamonina.. (2014). “Waves in metamaterials.”, Oxford: Oxford University Press.
57. Caloz, C., Itoh, T. (2010). “ Electromagnetic metamaterials: transmission line theory and microwave applications: the engineering approach.”, Hoboken, NJ: John Wiley and Sons.
58. Pal, D., Patnaik, A. (2010). “An analytical formulation of metamaterial-based compact patch antennas.”, International Journal of electronics Letters, 1-8.
59. Varma, R., Sharma, S., and Singh, B. (2014). “Improvement in Rectangular Microstrip Patch Antenna Parameters Using Metamaterial with Active Devices.”, 2014 International Conference on Devices, Circuits and Communications (ICDCCCom).
60. Jain, S. K., Shrivastava, A., and Shrivastava, G. (2015). “Miniaturization of microstrip patch antenna using metamaterial loaded with SRR.” 2015 International Conference on
61. D. M. Pozar and D. H. Schaubert , “Microstrip Antennas: The Analysis and Design of Microstrip Antennas and Arrays”, New York: IEEE Press, 1995.
62. J. R. James and P. S. Hall, “ Handbook of Microstrip Antennas .”, London, U.K.: Peter Peregrinus, 1989
63. K. S. Zheng, W. Y. Tam and D. B. Ge, “Broadside subwavelength Microstrip Antennas Partially Loaded with Metamaterials”, proc. Metamaterials, 2008 International Workshop, pp. 39-42, Nov. 2008
64. K. S. Zheng, W. Y. Tam and D. B. Ge, “Impedance Matching of Rectangular Microstrip Antennas partially loaded with DNG metamaterials”, Microwave Conference , 2008, pp. 678-681, EuMC 2008. 38th European, Oct. 2008.
65. W. Xu, L. –W. Li, H.-Y. Yao and T.-S. “Yeo,Left-handed Material Effects on Waves Modes and Resonant Frequencies: Filled Waveguide Structures and Substrate-Loaded

- Patch Antennas”, *J. of Electromagnetic Waves and Appl.*, Vol. 19, no. 15, pp. 2033-2047, 2005
66. “Handbook of Artificial Materials: Applications of Metamaterials” , F. Capolino, ed., Taylor and Francis - CRC Press , Vol. 2, pp. 18.1-18.14, Oct. 2009.
 67. D. Guha, M. Biswas, and Y. M. M. Antar, “Microstrip patch antenna with defected ground structure for cross polarization suppression”, *IEEE Antennas Wireless Propag. Lett.* , vol. 4, pp. 455–458, 2005.
 68. W. Xu, L. –W. Li, H.-Y. Yao and T.-S. Yeo, “Left-handed Material Effects on Waves Modes and Resonant Frequencies: Filled Waveguide Structures and Substrate-Loaded Patch Antennas”, *J. of Electromagn. Waves and Appl.*, Vol-19, no-15, 2033-2047, 2005.
 69. W. Pan, D.F. Wang, and F.Y. Meng, “Design, Verification and Applications in Antenna and Resonator Cavity Miniaturization of Compact Left- handed Metamaterial”, *I.J. Wireless and Microwave Technologies* , 2009, Vol. 1, pp. 10–18.
 70. K. Sarabandi, “A Substrate for Small Patch Antennas Providing Tunable Miniaturization Factors”, *IEEE Transactions on Microwave Theory and Techniques* , Vol.54, no.1, Jan. 2006
 71. sin Chang, Stuart A. Long, William F. Richards, “An Experimental Investigation of electrically Thick Rectangular Microstrip Antennas”, *IEEE Transactions on Antennas and Propagation* . Vol. AP-34, No. 6, Jun. 1986.
 72. Pozar, D. M. (2012). “ Microwave engineering .” Hoboken, NJ: Wiley.
 73. Sadiku, M. N. (2015). “ Elements of electromagnetic” . New York: Oxford University