

**ANALYTICAL PERFORMANCE EVALUATION OF A  
WIRELESS MOBILE COMMUNICATION SYSTEM WITH  
SPACE DIVERSITY**

Mohammed Jabir Mowla

Student ID: 053100

Mohammad Shabab Zaman

Student ID: 05310054

**Department of Computer Science and Engineering**

September 2007

## **Declaration**

We hereby declare that this thesis is my own unaided work, and hereby certify that unless otherwise stated, all work contained within this paper is ours to the best of our knowledge.

This thesis is being submitted for the degree of Bachelor of Science in Engineering at BRAC University.

---

Mohammed Jabir Mowla

---

Mohammad Shabab Zaman

## **Acknowledgements**

We would like to thank our supervisor, Professor Dr. Satya Prasad Majumder for his patience, guidance and expertise throughout this thesis.

We are grateful to the following people for their helpful advices and assistance:

- Dr. Sayeed Salam – Chairperson Dept. of Computer Science and Engineering BRAC University
- Dr. Mumit Khan - Associate Professor Dept. of Computer Science and Engineering BRAC University
- Dr. Tarik Ahmed Chowdhury - Assistant Professor Dept. of Computer Science and Engineering BRAC University

## **Abstract**

A theoretical analysis is presented to evaluate the bit error rate (BER) performance of a wireless communication system with space diversity to combat the effect of fading. Multiple receiving antennas with single transmitting antenna are considered with slow and fast fading. Performance results are evaluated for a number of receive antennas and the improvement in receiver performance is evaluated at a specific error probability ( $10^{-8}$  and  $10^{-9}$ ). It is found that diversity offers a significant improvement in the receiver sensitivity for both the cases of fast and slow fading.

## List of Figures and Tables

<b>Fig.1</b>	Block diagram of a Generic Communication System
<b>Fig.2</b>	Multipath Transmission
<b>Fig.3</b>	Space Diversity Receiving
<b>Fig 4</b>	Bit error rate curves for various modulation schemes
<b>Fig.5</b>	Doppler Power Spectrum
<b>Fig.6</b>	DPSK with MRC Reception
<b>Fig.7</b>	Improvement in Receiver's Sensitivity with MRC
<b>Fig.8</b>	DPSK with MRC using MGF
<b>Fig.9</b>	Improvement in Receiver's Sensitivity using MGF.
<b>Fig.10</b>	DPSK Fast Fading
<b>Fig.11</b>	DPSK Fast Fading with MRC
<b>Fig.12</b>	DPSK Power Penalty
<b>Table-1</b>	Irreducible Error Floor for multiple antennas

## List of Abbreviations and Acronyms

<b>AWGN</b>	Additive White Gaussian Noise
<b>BER</b>	Bit Error Rate
<b>BPSK</b>	Binary Phase Shift Keying
<b>CDMA</b>	Code Division Multiple Access
<b>dB</b>	Decibels
<b>D/A</b>	Digital to Analog
<b>DO-QPSK</b>	Differential offset-Quadrature Phase Shift Keying
<b>DPSK</b>	Differential Phase Shift Keying
<b>DQPSK</b>	Differential Quadrature Phase Shift Keying
<b>DC</b>	Direct Current
<b><math>E_b N_o</math></b>	Bit energy to noise density
<b><math>f_D</math></b>	Doppler Spread
<b>FDD</b>	Frequency division duplexing
<b>GMSK</b>	Gaussian Minimum Phase Shift Keying
<b>ISI</b>	Inter Symbol Interference
<b>NLOS</b>	Non- Line of Sight
<b><math>P(e)</math></b>	Probability of Error as $P_e$ or BER
<b><math>P_d</math></b>	Probability Density Function
<b>SIMO</b>	Single Input Multiple Output
<b>TDD</b>	Time division duplexing

<b>CHAPTER 1 .....</b>	<b>1</b>
<b>INTRODUCTION .....</b>	<b>1</b>
1.1 INTRODUCTION TO COMMUNICATION SYSTEMS.....	1
1.2 MULTIPLE ACCESS TECHNIQUES .....	3
1.3 LIMITATION OF WIRELESS COMMUNICATION SYSTEMS.....	4
1.4 OBJECTIVES OF THE PROJECT WORK .....	7
<b>CHAPTER 2 .....</b>	<b>8</b>
<b>WIRELESS COMMUNICATION SYSTEM .....</b>	<b>8</b>
2.1 SYSTEM BLOCK DIAGRAM.....	8
2.2 MODULATION SCHEMES .....	9
2.3 FAST AND SLOW FADING .....	13
2.3.1 Slow fading.....	13
2.3.2 Fast fading.....	15
2.3.3 Doppler Spread.....	16
2.4 DIVERSITY SCHEMES .....	17
<b>CHAPTER 3 .....</b>	<b>20</b>
<b>ANALYSIS OF BIT ERROR RATE IN A WIRELESS COMMUNICATION CHANNEL .....</b>	<b>20</b>
3.1 PROBABILITY OF ERROR FOR SLOW FADING WITHOUT DIVERSITY.....	20
3.2 PROBABILITY OF ERROR FOR FAST FADING WITHOUT DIVERSITY.....	22
3.3 DIVERSITY WITH SLOW FADING.....	23
3.4 DIVERSITY WITH FAST FADING.....	26
3.4.1 Diversity with Moment Generating Function .....	27
<b>CHAPTER 4 .....</b>	<b>30</b>
<b>RESULTS AND DISCUSSION .....</b>	<b>30</b>
4.1 RESULTS WITH SLOW FADING .....	30
4.2 RESULTS WITH FAST FADING.....	33
<b>CHAPTER 5 .....</b>	<b>38</b>
5.1 CONCLUSION.....	38
5.2 FUTURE WORK.....	38
<b>CHAPTER 6 .....</b>	<b>40</b>
<b>REFERENCES .....</b>	<b>40</b>

# Chapter 1

## INTRODUCTION

### 1.1 Introduction to Communication Systems

Wireless communications is, by any measure, the fastest growing segment of the communications industry. As such, it has captured the attention of the media and the imagination of the public. Cellular systems have experienced exponential growth over the last decade and there are currently around two billion users worldwide. Indeed, cellular phones, or mobile phones, as they are commonly known, have become a critical business tool and a part of everyday life in most developed and developing countries such as Bangladesh.

Early radio systems transmitted analog signals. Today most radio systems transmit digital signals composed of binary bits, where the bits are obtained directly from a data signal or by digitizing an analog signal. A digital radio can transmit a continuous bit stream or it can group the bits into packets. The latter type of radio is called a *packet radio* and is often characterized by bursty transmissions: the radio is idle except when it transmits a packet, although it may transmit packets continuously.

The term mobile has historically been used to classify any radio terminal that could be moved during operation. Most people are familiar with a number of mobile radio communications systems used in everyday life. Television remote controllers, cordless telephones, hand-held walkie-talkies, pagers and cellular telephones are all example of mobile radio communications systems. However the cost, complexity, performance, and types of services offered by each of these mobile systems are vastly different. More recently, the term mobile is used to describe a radio terminal that is attached to a high speed mobile platform e.g. a



cellular telephone in a fast moving vehicle, whereas the term portable describes the radio terminal that can be hand-held and used by someone at a walking speed (e.g. a walkie-talkie or a cordless telephone inside a home). The term subscriber is often used to describe a mobile or portable user, and each user's communication device is called a subscriber unit. In general, the collective group of users in a wireless system is called users or mobiles.

Wireless communication has advanced ever so much in the past thirty years that after satellite communication, optical communication is the thing of for the future. Optical communication is any form of telecommunication that uses light as the transmission medium. An optical communication system consists of a transmitter, which encodes a message into an optical signal, a channel, which carries the signal to its destination, and a receiver, which reproduces the message from the received optical signal.

A block diagram of a generic communications system is given by figure 1 where a signal is first modulated then sent through the transmitted through the channel which is received by the receiver and demodulated to find the transmitted signal at the receiver.

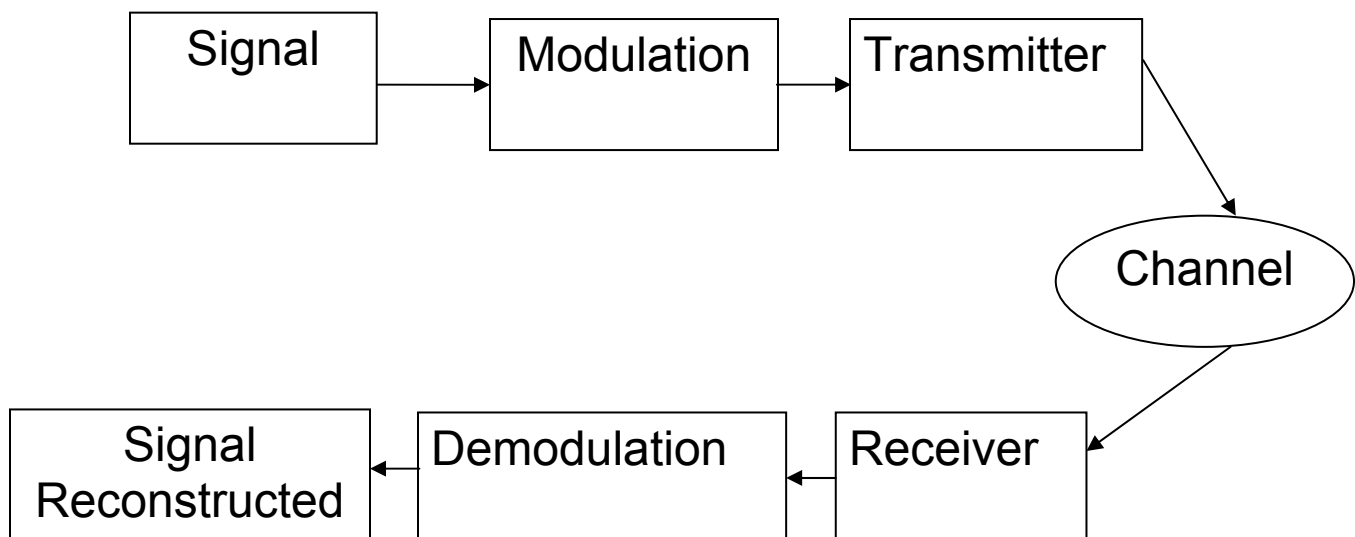

**Figure 1 Block diagram of a Generic Communication System**

## 1.2 Multiple Access Techniques

Mobile radio transmission systems may be classified as simplex, half-duplex or full duplex. In simplex systems communications is possible in only one direction, for example in paging systems where messages are received but not acknowledged for. Half-duplex radio systems allow two-way communication, but use the same radio channel for both transmission and reception. This means that at any given time only one user can transmit or receive information. But full-duplex systems allow simultaneous radio transmission and reception between a subscriber and a base station by providing two simultaneous but separate channels (frequency division duplex), or adjacent slots on a single radio channel (time division duplex).

Since wireless communications use this full-duplex technique to send and receive information simultaneously from the base station. This duplexing can be done using frequency or time domain techniques. Frequency division duplexing (FDD) provides two distinct bands of frequencies for every user. The forward band provides traffic from the base station to the mobile, and the reverse band provides traffic from the mobile to the base station. To facilitate FDD, it is necessary to separate the forward and reverse channels by a certain amount which is constant throughout the system regardless of the particular channel being used.

Time division duplexing (TDD) uses time instead of frequency to provide both a forward and reverse link. In TDD, multiple users share a single radio channel by taking turns in the time domain. Individual users are allowed to access the channel in assigned time slots, and each duplex channel has both forward and reverse time slots to facilitate bidirectional communication.

Multiple access schemes are used to allow many mobile users to share simultaneously a finite amount of radio spectrum. The sharing of spectrum is required to achieve high capacity by simultaneously allocating the available bandwidth or the available number of channels to multiple users. For high quality communications, this must be done without severe degradation in the performance of the system.

Frequency division multiple access (FDMA), time division multiple access (TDMA), and code division multiple access (CDMA) are three major types of access techniques used to share the available bandwidth in a wireless communications system.

FDMA assigns individual channels to individual users. Each user is allocated a unique frequency band or channel, these channels are assigned on demand to users who request service. During the period of the call no other user can share the same channel. In FDD systems, the users are assigned a channel as a pair of frequencies, one frequency is used for the forward channel while the other one is the reverse channel.

TDMA systems divide the radio spectrum into time slots, and in each slot only one user is allowed to either transmit or receive. Each user occupies a cyclically repeating time slot, so a channel may be thought of as a particular time slot that reoccurs every frame.

### **1.3 Limitation of Wireless Communication Systems**

The main problem of mobile systems undergoes severe degradation because they suffer from fading in a mobile environment [1-4]. Because the

channel is a randomly behaving entity, it will change the transmitted signal randomly and if we do not coherently detect and demodulate the signal, reconstruction is impossible. Fading due to various factors like speed of the transmitter, speed of the receiver, speed of the surrounding objects, channel parameters, like delay and Doppler spread, gives rise to bit error rates (BER), which generally means that the transmitted signal gets corrupted by the channel and the average probability of bit error is what we will be considering here.

Fading is used to describe the rapid fluctuations of the amplitudes, phases, or multipath delays of a radio signal over a short period of time or travel distance. Fading is caused by interference between two or more versions of the transmitted signal which arrive at the receiver at slightly different times. This sort of fading is known as multipath fading shown by fig 1.3-1

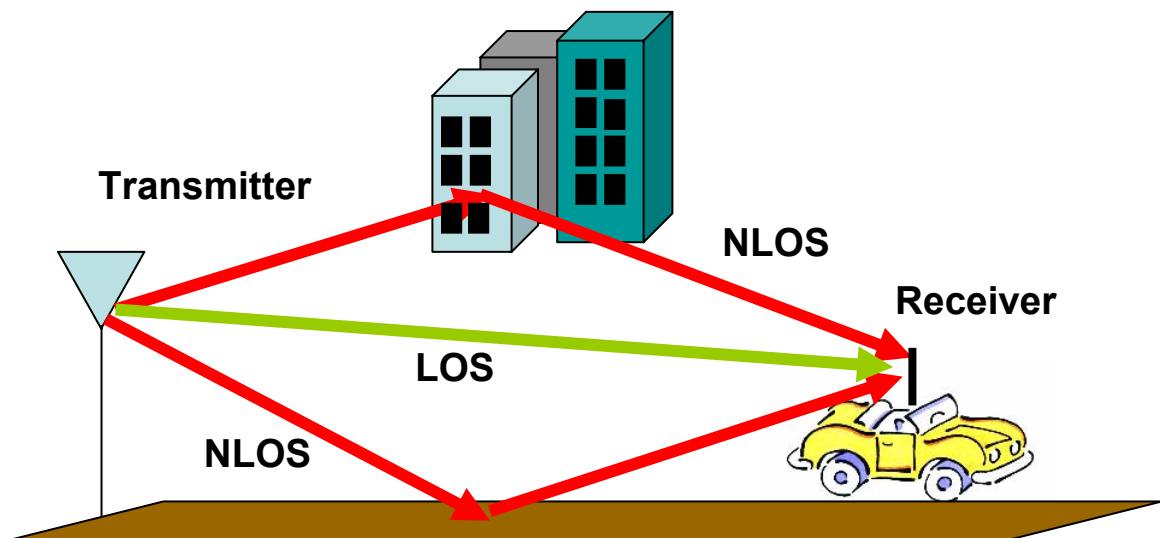

**Figure 2 Multipath Transmission**

In urban areas, fading occurs because the height of the mobile antennas are well below the height of the surrounding structures, so there is no single line-of-sight (LOS) path to the base station. Even when LOS exists, multipath still

occurs due to reflections from the ground and surrounding structures. The incoming radio waves arrive from different directions with different propagation delays. The signal received by the mobile at any point in space may consist of a large number of plane waves having randomly distributed amplitudes and phases. Even when a mobile receiver is stationary, the signal may fade due to movement of the surrounding objects in the radio channel.

The effects of multipath include constructive and destructive interference, and phase shifting of the signal. This causes Rayleigh fading, which would be elaborated on in the chapters that follow. The standard statistical model of this gives a distribution known as the Rayleigh distribution. Rayleigh fading with a strong line of sight content is said to have a Rician distribution, or to be Rician fading.

Another problem that a wireless channel faces is noise. Noise is a random signal (or process) with a flat power spectral density. In other words, the signal's power spectral density has equal power in any band, at any centre frequency, having a given bandwidth. White noise is considered analogous to white light which contains all frequencies. An infinite-bandwidth white noise signal is purely a theoretical construction. By having power at all frequencies, the total power of such a signal is infinite. In practice, a signal can be "white" with a flat spectrum over a defined frequency band.

The term white noise is also commonly applied to a noise signal in the spatial domain which has an autocorrelation which can be represented by a delta function over the relevant space dimensions. The signal is then "white" in the spatial frequency domain (this is equally true for signals in the angular frequency domain, e.g. the distribution of a signal across all angles in the night sky). The image to the right displays a finite length, discrete time realization of a white noise process generated from a computer.

Gaussian white noise is a good approximation of many real-world situations and generates mathematically tractable models. These models are used so frequently that the term additive white Gaussian noise has a standard abbreviation: AWGN. Gaussian white noise has the useful statistical property that its values are independent. AWGN does not account for fading but is used as a model in satellite and deep space communication links. It is not a good model for most terrestrial links because of multipath, terrain blocking, interference, etc. However for terrestrial path modeling, AWGN is commonly used to simulate background noise of the channel under study, in addition to multipath, terrain blocking, interference, ground clutter and self interference that modern radio systems encounter in terrestrial operation.

In an AWGN channel the modulated signal has noise added to it prior to reception. The noise is a white Gaussian random process with mean zero and the received signal is thus the summation of the signal itself and the noise.

#### **1.4 Objectives of the Project Work**

Previous works has been done with diversity for non-selective Rayleigh fading channels and for fast fading channels with single transmitting and single receiving antennas [2-5]. In this paper error probability is evaluated analytically for Rayleigh fading, first with slow fading and then in a fast fading environment and comparison is made for different number of antennas using Differential Phase Shift Keying (DPSK) modulation technique. To calculate error probability with diversity in fast fading, various values of Doppler spread was considered where we get an irreducible error floor. Error floor is significantly reduced for higher diversity order. Optimum diversity orders are commented for both slow and fast fading in with reference to their respective evaluating parameters. Diversity is considered because it mitigates the effects of fading. [11][12][13]

## Chapter 2

### Wireless Communication System

#### 2.1 System Block Diagram

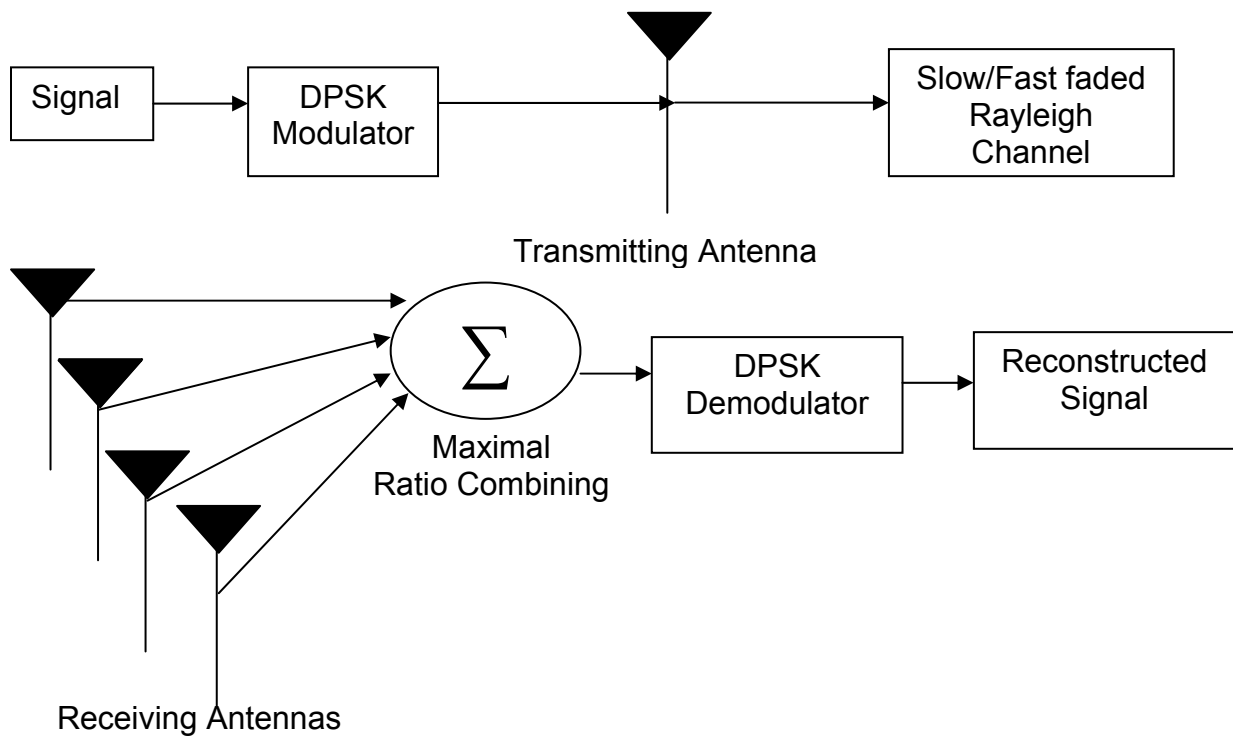

**Figure 3 Space Diversity Receiving**

The system block diagram is shown by figure 3, showing both the receiving and transmitting ends. If this is compared with the generic communications system diagram shown in fig. 1 we would see vast amounts of similarity, in case of the transmitting section the diagram is the same except that the modulation scheme is specified and the type of channel has been specified. Since we would be using Single input and Multiple output (SIMO) our receiving sector would contain more than one antenna where all the antennas would receive the transmitted signal after the signal undergoes slow or fast fading in a Rayleigh channel.

The received signal is combined using maximal ratio combining which the space diversity is combining technique used for this thesis paper. After undergoing combining the signal needs to be demodulated to get the original signal which was transmitted, despite the bit error rates and all the fading. The following sections will discuss the necessary required key terms and ideas to comprehend fully the system block diagram.

## **2.2 Modulation Schemes**

As we can see from the figure of the of the generic communication system figure 1, that signals need to be modulated before being transmitted and they need to be demodulated after reception. Modulation is the process of encoding information from a message source in a manner suitable for transmission. It generally involves translating a baseband signal to a bandpass signal at frequencies that are very high when compared to the baseband frequency. The bandpass signal is called the modulated signal and the baseband signal is called the modulating signal. Demodulation is just the reverse process of modulation which is a process of extracting the baseband message from the carrier so that it may be processed and interpreted by the intended receiver.

Modern mobile communication systems use digital modulation techniques. Digital modulation is much more robust to channel impairments, has greater noise immunity and greater security than analog modulation techniques. New multipurpose digital programmable signal processors have made it possible for modulators to be implemented strictly by software rather than having particular modem design frozen as hardware.



There are various modulation schemes used in digital wireless communication, such as Differential Quadrature Phase Shift Keying (DQPSK), Gaussian Minimum Phase Shift Keying (GMSK) and Differential offset-Quadrature Phase Shift Keying (DO-QPSK). The modulation technique used in this thesis paper is Differential Phase Shift Keying (DPSK). But to understand DPSK we need to understand Binary Phase Shift Keying which is the basis of DPSK.

Discrete phase modulation known as M-ary Phase Shift Keying, is among the most frequently used digital modulation techniques. Biphase or binary phase shift keying (BPSK) systems are considered the simplest form of phase shift keying (M=2). The modulated signal has two states,  $m_1(t)$  and  $m_2(t)$  given by

$$m_1(t) = +C \cos \omega_c t \quad (2.2-1)$$

$$m_2(t) = -C \cos \omega_c t \quad (2.2-2)$$

Normally the two phases are separated by by 180°. If the sinusoidal carrier has an amplitude  $A_c$ , and energy per bit  $E_b = \frac{1}{2} A_c^2 T_b$ , then the transmitted BPSK signal is either

$$s_{BPSK}(t) = \sqrt{2 \frac{E_b}{T_b}} \cos(2\pi f_c t + \theta_c) \quad 0 \leq t \leq T_b \text{ (binary 1)} \quad (2.2-3)$$

$$s_{BPSK}(t) = -\sqrt{2 \frac{E_b}{T_b}} \cos(2\pi f_c t + \theta_c) \quad 0 \leq t \leq T_b \text{ (binary 0)} \quad (2.2-4)$$

It is often convenient to generalize  $m_1$  and  $m_2$  as a binary data signal  $m(t)$ , which take on one of the two possible pulse shapes. Then the transmitted signal maybe represented as

$$s_{BPSK}(t) = m(t) \sqrt{2 \frac{E_b}{T_b}} \cos(2\pi f_c t + \theta_c) \quad 0 \leq t \leq T_b \quad (2.2-5)$$

The BPSK signal is equivalent to a double sideband suppressed carrier amplitude modulated waveform, where  $\cos(2\pi f_c t)$  is applied as the carrier and the data signal  $m(t)$  is applied as the modulating waveform. Hence BPSK signal can be generated using balanced modulator.

Differential Phase Shift Keying is a non coherent form of phase shift keying which avoids the need for a coherent reference signal at the receiver. Non coherent receivers are easy and cheap to build, and hence are widely used in wireless communication. In DPSK systems, the input binary sequence is first differentially encoded and then modulated using a BPSK modulator. The differentially encoded sequence  $\{d_k\}$  is generated from the input binary sequence  $\{m_k\}$  by complementing the modulo-2 sum of  $m_k$  and  $d_{k-1}$ . The effect is to leave the symbol  $d_k$  unchanged from the previous symbol if the incoming binary symbol  $m_k$  is 1, and toggle  $d_k$  if  $m_k$  is 0. The generation of DPSK signal for a sample sequence  $m_k$  which follows the relationship  $d_k = m_k \oplus d_{k-1}$

As mentioned for BPSK and QPSK there is an ambiguity of phase if the constellation is rotated by some effect in the communications channel the signal passes through. This problem can be overcome by using the data to change rather than set the phase.

For example, in differentially-encoded BPSK a binary '1' may be transmitted by adding  $180^\circ$  to the current phase and a binary '0' by adding  $0^\circ$  to the current phase. The modulated signal is shown below for both DBPSK and DQPSK as described above. It is assumed that the signal starts with zero phase, and so there is a phase shift in both signals at  $t = 0$ .

Analysis shows that differential encoding approximately doubles the error rate compared to ordinary M-PSK but this may be overcome by only a small increase in  $E_b / N_o$ . Furthermore, these analyses (and the graphical results shown in the results section) are based on a system in which the only corruption is additive white Gaussian noise. However, there will also be a physical channel between the transmitter and receiver in the communication system. This channel will, in general, introduce an unknown phase-shift to the PSK signal; in these cases the differential schemes can yield a better error-rate than the ordinary schemes which rely on precise phase information.

Differential schemes for other PSK modulations may be devised along similar lines. The waveforms for DPSK are the same as for differentially-encoded PSK given below since the only change between the two schemes is at the receiver.

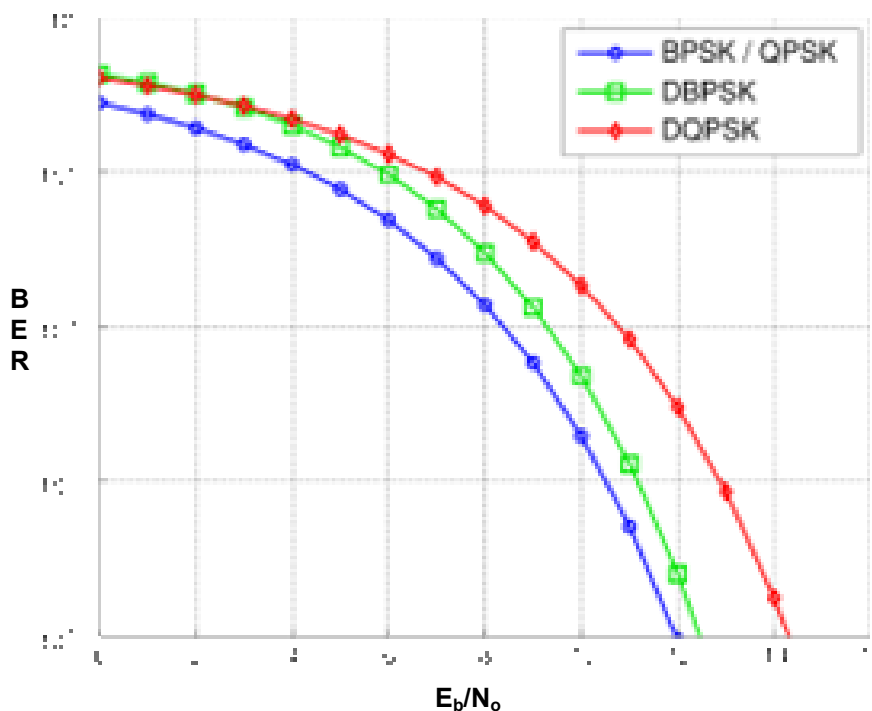

**Figure 4 Bit error rate curves for various modulation schemes**

## **2.3 Fast and Slow Fading**

As stated previously, fading is used to describe the rapid fluctuations of the amplitudes, phases, or multipath delays of a radio signal over a short period of time or travel distance. Researches have shown that or multipath propagation leads to both slow and fast fading.

The terms slow and fast fading refer to the rate at which the magnitude and phase change imposed by the channel on the signal changes. The coherence time is a measure of the minimum time required for the magnitude change of the channel to become de-correlated from its previous value.

Slow fading arises when the coherence time of the channel is large relative to the delay constraint of the channel. In this regime, the amplitude and phase change imposed by the channel can be considered roughly constant over the period of use. Slow fading can be caused by events such as shadowing, where a large obstruction such as a hill or large building obscures the main signal path between the transmitter and the receiver.

Fast Fading occurs when the coherence time of the channel is small relative to the delay constraint of the channel. In this regime, the amplitude and phase change imposed by the channel varies considerably over the period of use.

### **2.3.1 Slow fading**

The basic model of Rayleigh fading assumes a received multipath signal to consist of a (theoretically infinitely) large number of reflected waves with independent and identically distributed inphase and quadrature amplitudes. This model has played a major role in our understanding of mobile propagation.

Rayleigh fading is a statistical model for the effect of a propagation environment on a radio signal, such as that used by wireless devices. It assumes that the magnitude of a signal that has passed through the channel will vary randomly, or fade, according to a Rayleigh distribution — the radial component of the sum of two uncorrelated Gaussian random variables. It is a reasonable model for tropospheric and ionospheric signal propagation as well as the effect of heavily built-up urban environments on radio signals. Rayleigh fading is most applicable when there is no line of sight between the transmitter and receiver. If there is a line of sight, Rician fading is more applicable.

For Rayleigh faded channels the fading parameter  $\alpha$  has a Rayleigh distribution, which is denoted by  $p(\alpha)$ .

$$p(\alpha) = \begin{cases} \frac{\alpha}{\sigma^2} \exp\left(-\frac{\alpha^2}{2\sigma^2}\right) & \alpha \geq 0 \\ 0 & \alpha < 0 \end{cases} \quad (2.3-1)$$

where the fading power ( $\alpha^2$ ) has chi-square distribution with two degrees of freedom [7].

The model behind Rician fading is similar to that for Rayleigh fading, except that in Rician fading a strong dominant component is present. This dominant component can for instance be the line-of-sight wave. The distribution is given by

$$p(\alpha) = \begin{cases} \frac{\alpha}{\sigma^2} \exp\left(-\frac{(\alpha^2 + A^2)}{2\sigma^2}\right) I_0\left(\frac{A\alpha}{\sigma^2}\right) & (A \geq 0, \alpha \geq 0) \\ 0 & (\alpha < 0) \end{cases} \quad (2.3-2)$$

Where  $I_0$  is the modified Bessel function of the first kind and zero order and  $A$  is the peak amplitude of the LOS signal

As depicted here Ricean fading has a LOS component in its distribution but Rayleigh fading does not, and if we notice, we would see Rayleigh fading is Rician fading without the LOS component; hence Rayleigh fading is the worst case of fading that a mobile channel can undergo.

### **2.3.2 Fast fading**

Fast fading is the case when any or both of the transmitting or receiving end is moving with some relative speed to the other. As the signal is transmitted through multipath characteristic, the movement in the surrounding objects of the transmitter/receiver also causes fast fading. As the coherence time becomes smaller than the symbol/bit period the signal undergoes frequency selective fading.

In slow fading conditions where the channel coherence time is greater than the symbol/bit period the signal essentially undergoes constant attenuation, the multipath delay spread also stays within the symbol time. But the effect of motion causes all the multipath signals to arrive later than usual time. This essentially causes the delay spread to exceed the symbol time. As the delay spread increases and exceeds the symbol time the inter symbol interference (ISI) increases drastically. The inter symbol interference is independent of the signal to noise ratio, because as the power of the signal is increased the ISI also gets increased.

The effect of inter symbol interference causes irreducible error floors in the bit error rate of any modulation. These error floors start to become dominant at

some level of signal to noise ratio. So if the symbol time can be increased so that prolonged multipath delay spreads can also be accommodated within the symbol time then successful omission of ISI can be achieved. ISI can be tackled successfully using OFDM (Orthogonal Frequency Division Multiplexing) technologies

### 2.3.3 Doppler Spread

There is another cause of error floors in bit error rates which is tougher to handle. This effect is known as Spectral broadening of the carrier frequency. As receivers or transmitters are moving with some speed, the other ends received signal undergoes Doppler shift. This is a normal shift in the baseband signal. This shifts in frequency causes a spectral broadening in the carrier frequency that is known as Doppler Spread. The received signal thus undergoes almost random frequency modulation due to the Doppler shifts and become the effective cause of the irreducible error floors.

For our purpose we assumed that the Doppler spread was initiated by uniform scattering and that the Doppler power spectrum is given by Clarke's Model

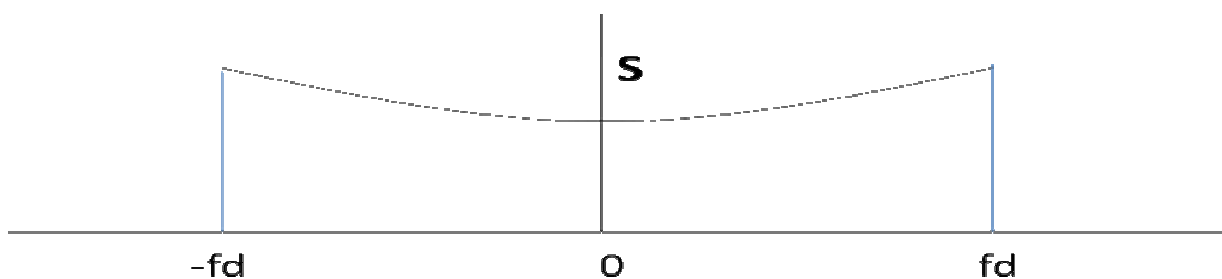

Figure 5 Doppler Power Spectrum

$$\mathbf{s} = \frac{1}{\pi \sqrt{f_d^2 - f^2}} \quad |f| \leq f_d \quad (3.1-1)$$

Figure 5 shows the Doppler power spectrum for uniform scattering given by (3.1-1) [6], where  $f_d$  is the maximum Doppler frequency and  $S$  is the Doppler power spectrum for the baseband carrier frequency which has not been shown in the figure 5. The signal fading variance is taken to be one for simplification.

The Doppler power spectrum is the frequency domain representation of the Doppler spread for a carrier frequency but it does have less significance in calculations related to the bit error rates. Thus we require a time domain equivalent of (3.1-1).

Taking inverse Fourier Transform of the Doppler power spectrum we get the channel correlation coefficient given by (3.1-2).

$$\Phi = J_0(2\pi f_d \Delta t) \quad (3.1-2)$$

Here  $\Phi$  is the channel correlation coefficient and  $\Delta t$  is the symbol/bit time and  $J_0$  is the zero order Bessel function of the first kind. It can be clearly seen that the channel correlation coefficient is a function of the product of  $f_d$  and  $\Delta t$ .

## 2.4 Diversity Schemes

Improving the performance of any communication system means to be able to tackle high bit error rate for minimum signal power. To improve this condition and performance simple techniques of diversity can be applied. Diversity essentially refers to three types firstly space diversity, secondly time diversity and finally frequency diversity.

Time diversity is the condition where the same signal is transmitted over different time slots in bursts data or in some other way. This technique can be



adopted to attain higher performance but the multipath delay spreads and random attenuation might not lead to a significant improvement in performance.

Frequency diversity has been studied for the past two decades and researchers are trying hard to come up with efficient schemes like OFDM. In the future frequency diversity will be effectively combined with space diversity to tackle higher attenuation and high improvement in bit error rate.

Space diversity which is the most popular and widely used of all the three requires that the same signal is transmitted over multiple antennas. The different schemes are as follows.

- Single Input Multiple Output (SIMO)
- Multiple Input Multiple Output (MIMO)

SIMO is mostly used and it has significant improvement in receiver's sensitivity. Systems involving Multiple input and single output can also be used but it is less effective than SIMO, because the total transmitting signal's power is divided among all the individual transmitting antennas. Whereas in SIMO system all the received signals of individual antennas are combined according to some criterion to achieve high signal to noise ration to get low bit error rates. In receiver's diversity three basic processes are followed. These processes have their own usage and complexity. The processes are as follows.

- Maximal Ratio Combining (MRC)
- Selection Combining (SC)
- Equal Gain Combining (EGC)

Selection combining is most useful in wireless communication channels. Here all the individual antennas' signal is constantly checked to ensure that the signal power over a certain threshold value is taken in. Selection Combining mostly works on the basis of some threshold value which can be fixed according to certain desired tolerance value of bit error rate. The single most inefficient thing is that, in this procedure even the highest powered signal might not be considered due to the fact that the checking for one signal stops at that instant when a value greater than certain threshold is found.

Maximal ratio combining is the process where the outputs signal to noise ratio is simply the weighted sum of all the individual antennas' signal. MRC particularly gives much better performance than any other diversity technique. But in this technique the received signals need to be co – phased in order to sum them up and this is the most crucial factor in the MRC technique. MRC is the most popular and widely used space diversity technique for any wireless system.

## CHAPTER 3

### ANALYSIS OF BIT ERROR RATE IN A WIRELESS COMMUNICATION CHANNEL

#### 3.1 Probability of Error for Slow Fading Without Diversity

The probability of error of any modulation scheme is a function of its signal to noise ratio ( $SNR = \gamma$ ), where  $\gamma = \alpha^2 \frac{E_b}{N_o}$ ,  $E_b$  is the average energy per bit and  $N_o$  is the power density in a non fading additive white Gaussian noise (AWGN) channel and  $\alpha^2$  is the instantaneous power of the fading parameter. To evaluate the probability of error of DPSK in a slow faded channel we must average the probability of error in AWGN channel over the possible range of signal strength due to fading. The error probability in an AWGN channel is a conditional error probability where the condition is that  $P_e$  is fixed. Thus the error probability ( $P_e$ ) in AWGN is given by (3.1-1).

$$P_e = \frac{1}{2} \exp(-\gamma) \quad (3.1-1)$$

Using Rayleigh fading distribution function and considering that the fading power and SNR has a chi square distribution with two degrees of freedom hence

$$p(\gamma) = \frac{1}{\Gamma} \exp\left(-\frac{\gamma}{\Gamma}\right) \quad \gamma > 0 \quad (3.1-2)$$

Where,  $\Gamma = \frac{E_b}{N_o} \overline{\alpha^2}$ . It is convenient to assume  $\overline{\alpha^2} = 1$  for unity gain fading channel and thus  $\Gamma$  is the average SNR per bit. Therefore the expression for average probability of error is

$$P_e = \int_0^{\infty} P(\gamma) p(\gamma) d\gamma \quad (3.1-3)$$

Where  $p(\gamma)$  is the conditioned error probability in AWGN and  $P(\gamma)$  is given by (2.3-2).

To evaluate the closed form equation we will use the moment generating function (MGF) approach, the generalized form of MGF is given by (3.1-4).

$$M_\gamma(\mathbf{s}) = \int_0^{\infty} p(\gamma) \exp(-\mathbf{s}\gamma) d\gamma \quad (3.1-4)$$

for Rayleigh distribution the MGF is given by (3.1-5).

$$M_\gamma(\mathbf{s}) = (1 - \mathbf{s}\gamma)^{-1} \quad (3.1-5)$$

The MGF is a very useful tool in performance analysis of modulation in fading both with and without diversity

For MGF it is required to express the AWGN  $P_e$  of DPSK as a finite range integral for constants  $c_1$  and  $c_2$  as an exponential function of  $\gamma$  as shown in (3.1-6).

$$P_e = \int_0^{\infty} c_1 \times \exp(c_2 \times \gamma) p(\gamma) d\gamma \quad (3.1-6)$$

By putting (3.1-1) in (3.1-3) it can be seen that (3.1-3) exactly has the form of (3.1-6) with  $c_1 = 1/2$  and  $c_2 = -1$ . Thus leading to (3.1-7).

$$c_1 \times M_\gamma(-c_2) \quad (3.1-7)$$

Using (3.1-7) we evaluate the average probability of error in Rayleigh faded channels as (3.1-8).

$$P_e = [2(1 + \Gamma)]^{-1} \quad (3.1-8)$$

(3.1-8) can be further simplified to (2.3-9) which is a smaller form for high  $\Gamma$ .

$$P_e \approx \frac{1}{2(\Gamma)} \quad (3.1-9)$$

Thus (3.1-8) or (3.1-9) gives us the average error probability of slow faded channels.

### 3.2 Probability of Error for Fast Fading Without Diversity

Fast Fading Equations are not in closed form for most modulations. But for DPSK a closed form expression in fast fading where the channel de-correlates over a bit time can be derived for fast Ricean channels using the *MGF* technique, with the *MGF* obtained based on the general quadratic form of Gaussian random variables [6], [8]. The resulting  $P_e$  for DPSK is:

$$P_e = \frac{1}{2} \left[ \frac{1 + K + \gamma(1 - \Phi)}{1 + K + \gamma} \right] \exp\left( \frac{K\gamma}{1 + K + \gamma} \right) \quad (3.2-1)$$

Here  $K$  is the fading parameter of Ricean distribution and  $\Phi$  is the channel correlation coefficient. For Rayleigh fading  $K = 0$ , [9] which makes the  $P_e$ .

$$P_e = \frac{1}{2} \left[ \frac{1 + \gamma(1 - \Phi)}{1 + \gamma} \right] \quad (3.2-2)$$

We have engaged the MRC procedure in our space diversity analysis, simply due to the fact that it offers higher performance than the others. Since we are dealing with frequency non-selective and frequency selective fading it was imperative for us to choose the diversity that would maximize our performance. We have been able to partially derive and combine closed form equations for space diversity in both frequency selective and non – selective channels. There were two techniques used in order to derive the necessary equations.

### 3.3 Diversity with Slow Fading

The first procedure involved the use of a decision variable  $U$  which is Gaussian and has a mean of

$$E(U) = 2\varepsilon \sum_{k=1}^L \alpha_k^2 \quad (3.3-1)$$

and variance:

$$\sigma_U^2 = 2\varepsilon N_o \sum_{k=1}^L \alpha_k^2 \quad (3.3-2)$$

For these values of the mean and variance, the conditional probability that  $U$  is less than zero is

$$P_2(\gamma_b) = Q\left(\sqrt{2\gamma_b}\right) \quad (3.3-3)$$

Here  $P_2$  is the conditional probability and  $Q$  is the generalized q function and  $\gamma_b$ , the SNR per bit is given by

$$\gamma_b = \frac{\varepsilon}{N_o} \sum_{k=1}^L \alpha_k^2 \quad (3.3-4)$$

$$\gamma_b = \sum_{k=1}^L \gamma_k \quad (3.3-5)$$

Where,  $\gamma_k = \frac{\varepsilon}{N_o} \alpha_k^2$  is the instantaneous SNR on the  $k$ th channel. Now it would be required to determine the probability density function  $P(\gamma_B)$ . This can be determined by its characteristic function. For  $L = 1$  and  $\gamma_1 = \gamma_b$  has a chi square probability function [6]. The characteristic function is given by.

$$\Psi(j\nu) = \mathbf{E} \times \exp(j\nu\gamma_1) \quad (3.3-6)$$

$$\psi(j\nu) = \frac{1}{1 - j\nu\gamma_c} \quad (3.3-7)$$

Where  $\gamma_c$  is the average SNR per channel, which can be assumed identical for all channels. Since for  $L$  channel the fading is independent in each individual branch the characteristic function is simply raised to the power of  $L$ . Which gives,

$$\Psi_{\gamma_b}(j\nu) = \frac{1}{(1 - j\nu\gamma_c)^L} \quad (3.3-8)$$

But this is essentially the characteristic function of a chi – square distributed random variable with  $2L$  degrees of freedom. Thus our resulting probability density function [6]  $p(\gamma_b)$  is,

$$p(\gamma_b) = \frac{1}{(L-1)! \gamma_c^L} \gamma_b^{L-1} \exp\left(-\frac{\gamma_b}{\gamma_c}\right) \quad (3.3-8)$$

The last step in the derivation procedure is to average the conditional probability of  $P_2(\gamma_b)$  over the fading channels statistics. Thus we get.

$$P_2 = \int_0^{\infty} P_2(\gamma_b) p(\gamma_b) d\gamma_b \quad (3.3-9)$$

The closed form equation of  $P_2$  can be expressed in the form shown in (3.3-10).

$$P_2 = \left[ \frac{1}{2(1-\mu)} \right]^L \sum_{k=0}^{L-1} \binom{L-1+k}{k} \left[ \frac{1}{2(1-\mu)} \right]^L \quad (3.3-10)$$

Where for DPSK,  $\mu = \frac{\gamma_c}{1 + \gamma_c}$

Where,  $\gamma_c$  is the average SNR per channel and is assumed to be same for all channels. Thus the relationship of the total combined SNR is  $\gamma_b = L\gamma_c$ . All



the results are plotted according to this relationship. The terms can be simplified for higher SNR to a simpler equation which is given by (3.3 -11).

$$P_2 \approx \left( \frac{1}{2\gamma_c} \right)^L \left( \frac{2L-1}{L} \right) \quad (3.3-11)$$

It is imperative to notice that the first term of (3.1-11) is simply the approximated value of a single Rayleigh channel for high SNR. For our purpose we will rewrite (3.3 -11) and get (3.3 -12).

$$P_2 \approx \left( \frac{1}{2(\gamma_c + 1)} \right)^L \left( \frac{2L-1}{L} \right) \quad (3.3-12)$$

This rewritten form will be very useful in deriving our fast fading equation with space diversity. [6]

### 3.4 Diversity with Fast Fading

So far diversity was used into consideration for a slowly fading Rayleigh channel but the scenario totally changes when a fast fading Rayleigh channel is used. For maximum ratio combining each branch is taken as an individual channel, thus the effect of and all properties of fast fading would still exist prominently and independently for each antenna just like a single SISO (Single Input Single Output) system.

To get the equation of fast fading channel in Diversity we would use (3.3-12) and replace  $\left( \frac{1}{2(1 + \Gamma_c)} \right)$  with  $\frac{1}{2} \left[ 1 + \Gamma_c \frac{1 - \Phi}{1 + \Gamma_c} \right]$ . As (3.2 -2) represents

our fast fading error probability for a SISO system, assuming each branch is independent our fast fading diversity equation simply leads to (3.4-1)

$$P_e \approx \frac{1}{2} \left[ \frac{1 + \Gamma_c(1 - \phi)}{1 + \Gamma_c} \right]^L \begin{bmatrix} 2L - 1 \\ L \end{bmatrix} \quad (3.4-1)$$

Thus (3.4 -1) gives us the average error probability of fast faded channels with diversity.

### 3.4.1 Diversity with Moment Generating Function

The simplicity of using MGFs in the analysis of MRC stems from the fact that, the combiner SNR is the sum of the individual branch SNRs.

$$\gamma_{\Sigma} = \sum_{i=1}^M \gamma_i \quad (3.4-1)$$

As in the analysis of average probability of error without diversity, let us assume that the probability of error in AWGN for the modulation of interest (DPSK) can be expressed as an exponential function of the finite integral function given by (3.1 -6).

We assume that the branch SNRs are independent, so that their joint probability distribution function becomes a product of the individual probability distribution functions  $p_{\gamma_1, \dots, \gamma_M}(\gamma_1, \dots, \gamma_M) = p_{\gamma_1}(\gamma_1) \dots p_{\gamma_M}(\gamma_M)$   
Using the factorization and substituting  $\gamma = \gamma_1 + \dots + \gamma_M$  in (2.3-6) yields

$$\overline{P_e} = c_1 \int_0^{\infty} \int_0^{\infty} \int_0^{\infty} \dots \int_0^{\infty} \exp \left[ -c_2 (\gamma_1 + \dots + \gamma_M) \right] p_{\gamma_1}(\gamma_1) \dots p_{\gamma_M}(\gamma_M) d_{\gamma_1} \dots d_{\gamma_M} \quad (3.4-2)$$

Now using the product forms  $\exp[-\beta(\gamma_1 + \dots + \gamma_M)] = \prod_{i=1}^M \exp[\beta\gamma_i]$  and

$p_{\gamma_1}(\gamma_1) \dots p_{\gamma_M}(\gamma_M) = \prod_{i=1}^M p_{\gamma_i}(\gamma_i)$  in (4.3-1) yields

$$\overline{P_e} = c_1 \int_0^\infty \int_0^\infty \int_0^\infty \dots \int_0^\infty \prod_{i=1}^M \exp[-c_2 \gamma_i p_{\gamma_i}(\gamma_i) d_{\gamma_i}] \quad (3.4-3)$$

Finally switching the order of intergration and multiplication in (4.3-3) yields our desired form

$$\overline{P_e} = c_1 \prod_{i=1}^M \int_0^\infty \exp[-c_2 \gamma_i] p_{\gamma_i}(\gamma_i) d_{\gamma_i} = c_1 \prod_{i=1}^M M_{\gamma_i}(-c_2) \quad (3.4-4)$$

Thus the average probability of symbol error is just the product of MGFs associated with the SNR on each branch. Similarly when  $P_e$  is in the form of

$$P_e = \int_A^B c_1 \exp[-c_2(x)\gamma] dx \quad (3.4-5)$$

We get

$$\overline{P_e} = \int_0^\infty \int_A^B c_1 \exp[-c_2(x)\gamma] dx p_\gamma(\gamma) d_\gamma = \int_0^\infty \int_0^\infty \dots \int_0^\infty \int_A^B c_1 \prod_{i=1}^M \exp[-c_2(x)\gamma_i] dx p_{\gamma_i}(\gamma_i) d_{\gamma_i} \quad (3.4-6)$$

Thus the average probability of error is just a single finite-range integral of the product of MGFs associated with the SNR on each branch. The equations (5.3-4) and (5.3-6) apply for any number of diversity branches and any type of fading distribution on each branch, as long as the branch SNRs are independent.

We now apply these general results to specific modulation and fading distributions, in our case the modulation technique is DPSK where the probability of error is  $P_e = \frac{1}{2} \exp(-\gamma)$  in AWGN. Thus from (4.3-4) the average probability of error in DPSK under M-fold Diversity is

$$\overline{P_b} = \frac{1}{2} \prod_{i=1}^M M_{\gamma_i}(-1) \quad (3.4-7)$$

Where  $M_{\gamma}(\mathbf{s}) = (1 - \mathbf{s}\gamma)^{-1}$  and

$$\overline{P_b} = \frac{1}{2} \prod_{i=1}^M (1 + \mathbf{s}\gamma_i)^{-1} \quad (3.4-8)$$

$$\overline{P_b} = \frac{1}{2} \prod_{i=1}^M \left( \frac{1}{1 + \gamma_i} \right) \quad (3.4-9)$$

## Chapter 4

### RESULTS AND DISCUSSION

The various equations derived and found are plotted in graphs to prove our result and corresponding comments and discussions are included in the following sections.

#### 4.1 Results with Slow Fading

The error probability or bit error rate (BER) is shown for different number of receiving antenna in Figure 6.

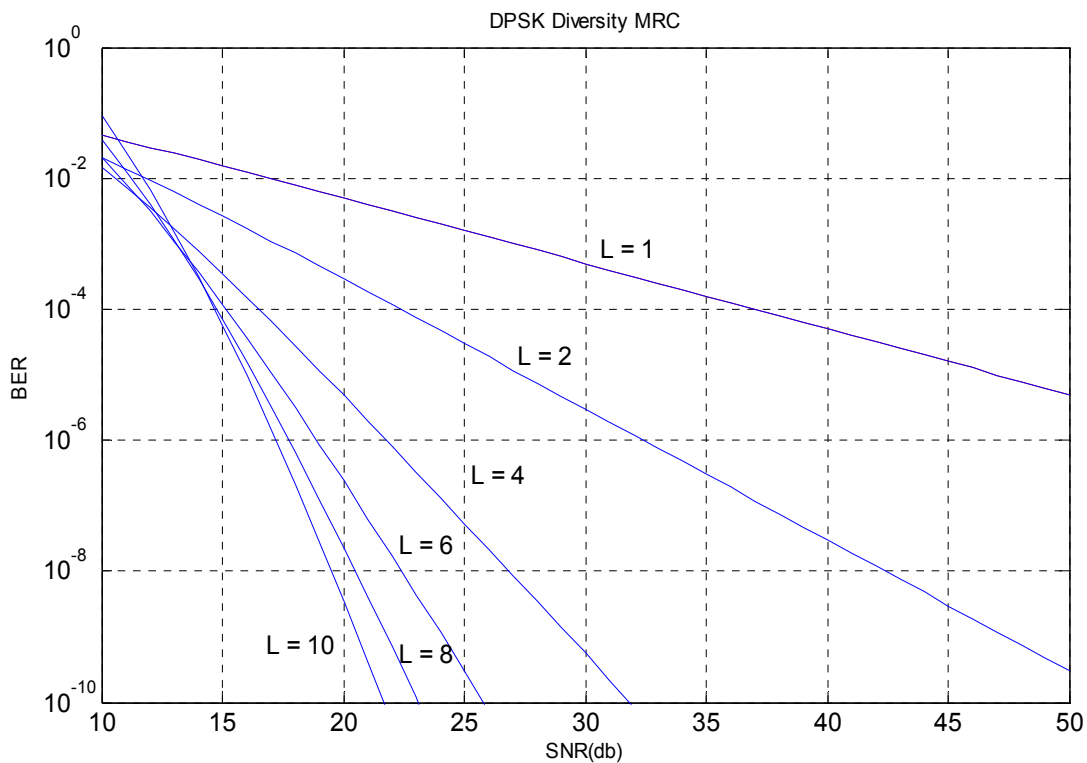
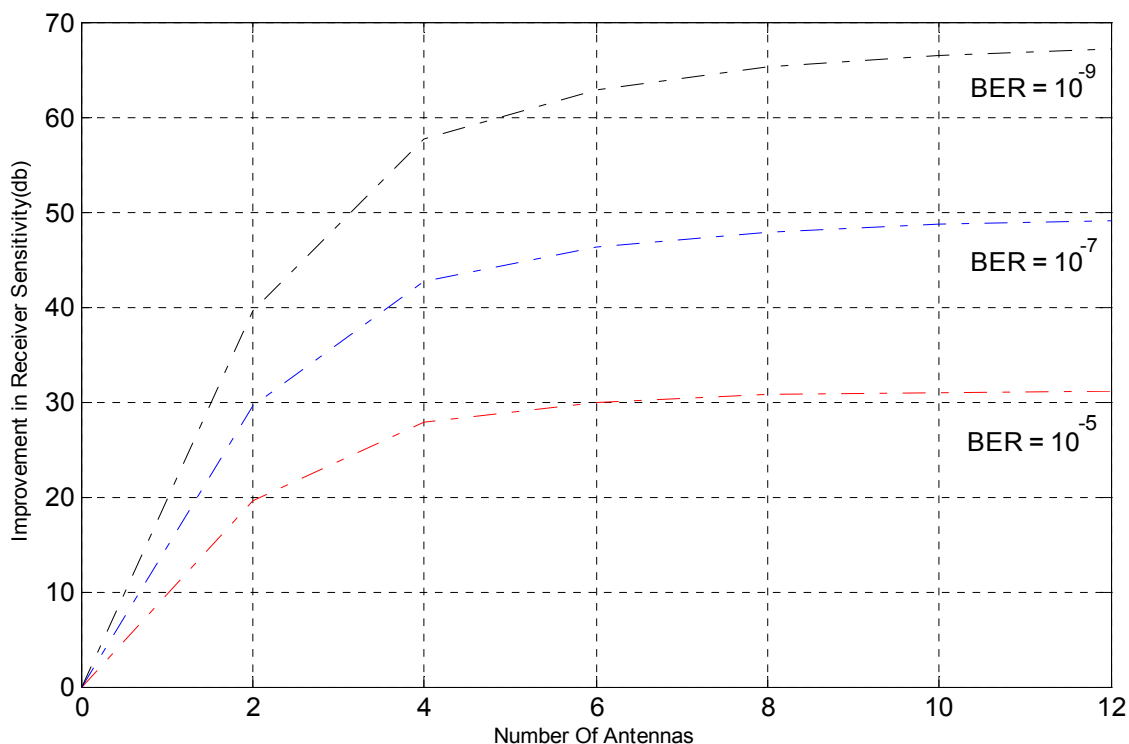

Figure 6 DPSK with MRC Reception

As shown in figure 6 the BER reduces drastically as number of antenna is increased but an important fact can be noticed that the BER does not reduce proportionally to the increase of  $L$ . The maximum BER reduction occurs when  $L$  is changed from 1 to 2 and 2 to 4.

For example, for a BER of  $(10^{-4})$ ,  $L = 1$  requires nearly  $36.9 \text{ db}$  of signal power, whereas  $L = 2$  requires only  $22.34 \text{ db}$  and  $L = 4$  requires just  $16.5 \text{ db}$ . A further analysis is produced in figure 7 where the improvement in Receiver sensitivity in decibels is plotted against the number of receiving antenna for different BER.

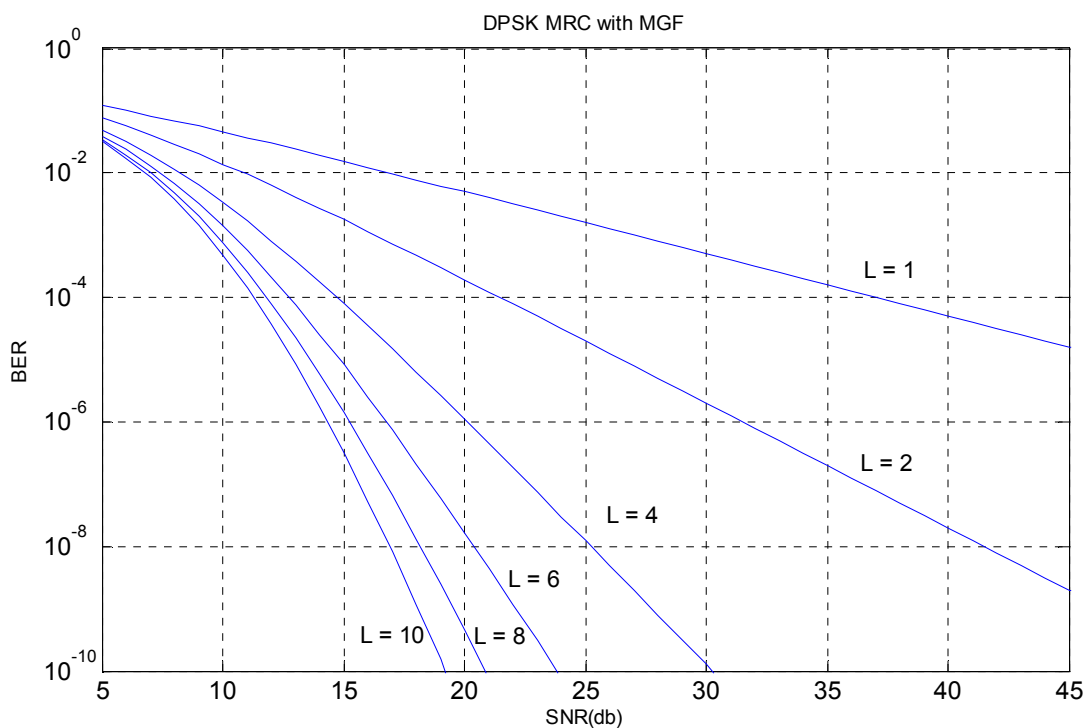

**Figure 7 Improvement in Receiver's Sensitivity with MRC**

The above figure shows the saturated improvement in Receiver sensitivity. The sensitivity increases significantly for higher BER but eventually saturates

even for higher number of antenna. Increasing the number of antenna to a higher extent would not lead to significant receiver sensitivity. Thus an optimum diversity order of 2 to 4 for slowly faded Rayleigh channel might be considered significantly optimum with reference to the saturated receiver's sensitivity, but higher orders can be used but it would not lead to much significant improvement in BER.

Figure 8 and figure 9 are plotted to show the same effect of saturation in sensitivity of receiver's improvement when the whole case was evaluated using the MGF technique discussed in chapter 3.



**Figure 8 DPSK with MRC using MGF**

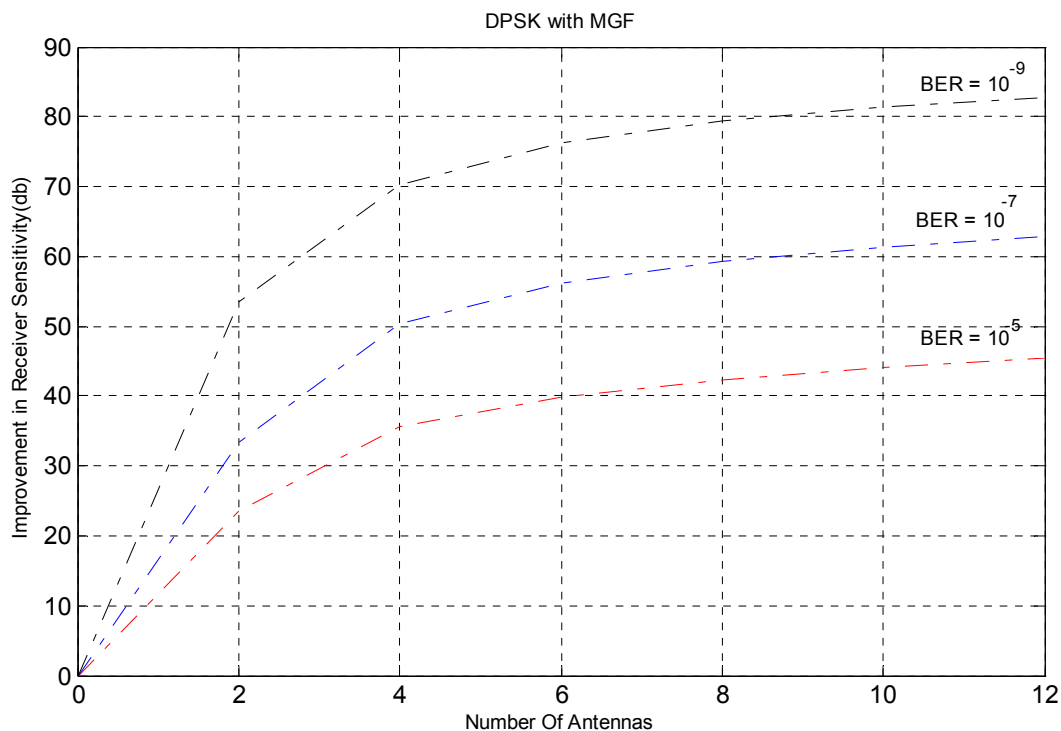

**Figure 9 Improvement in Receiver's Sensitivity using MGF**

Figure 6 and figure 7 were plotted from the approximated equation derived in chapter 3 and figure 8 and figure 9 are plotted using the MGF technique which is exact. Thus there is a little difference that is noticeable in the figures shown but the end effect is similar.

#### 4.2 Results with Fast Fading

The effect of fast fading is such that at some value of SNR an error floor starts to develop and it cannot be fought with even higher values of SNR. The error floor starts to dominate for values of  $fdTb > 0.001$ , where  $Tb$  is the time interval for one bit to transmit. Figure 10 shows the effect of fast fading for a single receiving antenna for different values of  $fdTb$ .



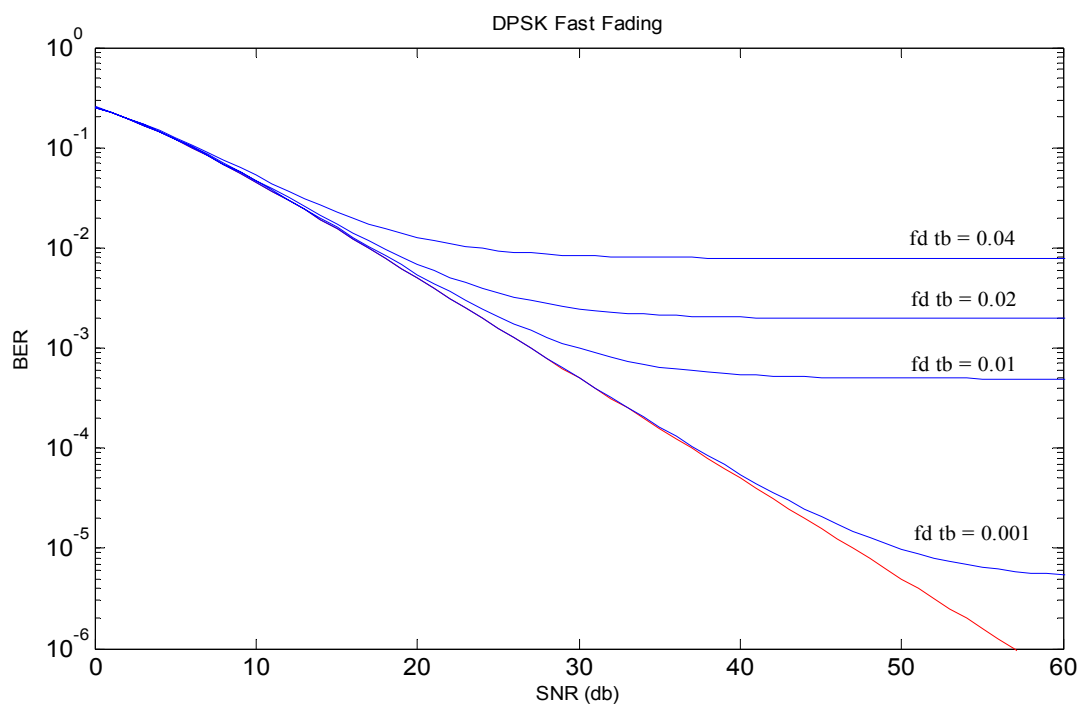

**Figure 10 DPSK with Fast Fading**

Figure 10 shows the effect of fast fading with diversity and it can be seen that the error floor can be forced to occur at lower values of BER[14].

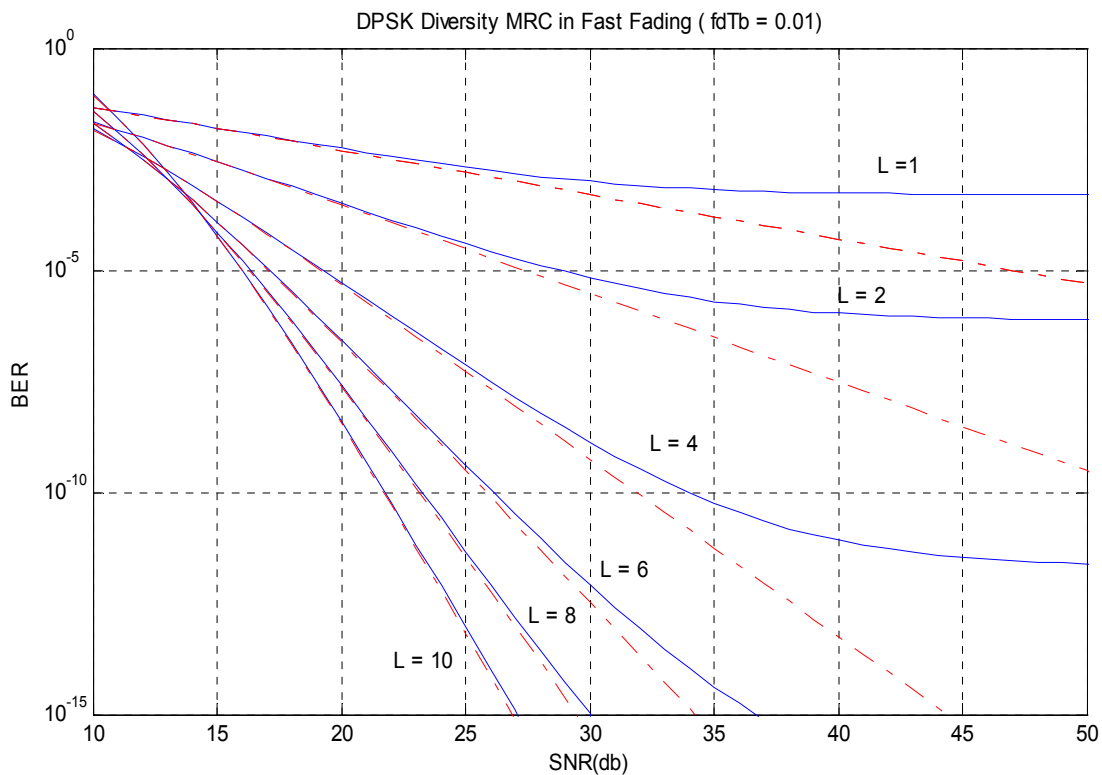

**Figure 11 DPSK wth Fast Fading with MRC**

Figure 11 was plotted for  $fdT_b = 0.01$  the dashed lines show the slowly faded signal and the solid lines shows the fast faded signal. As it can be seen even using two or four antenna the error floor dominates quite significantly. A further analysis in fig.11 shows the power penalty required for different values of  $fdT_b$ .

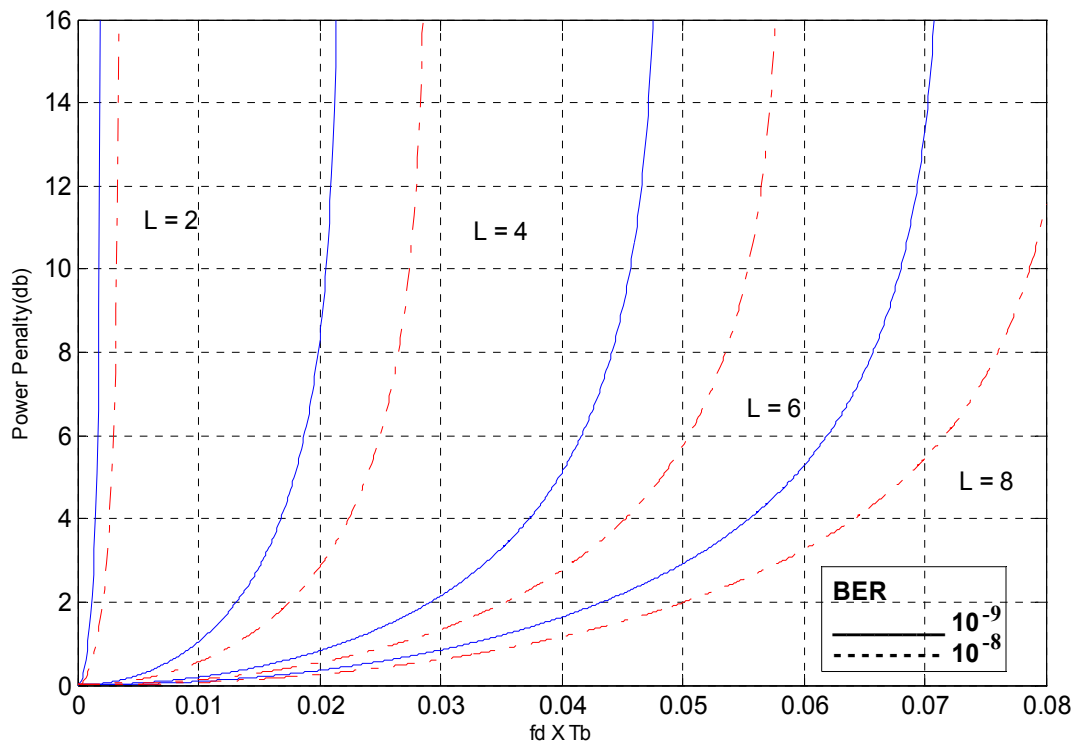

**Figure 12 DPSK Power Penalty**

The plot in figure 12 shows the power penalty with a fixed BER of different number of antennas for different values of  $fdTb$ . The dashed line indicates a BER of  $(10^{-8})$  and the solid line a BER of  $(10^{-9})$ . The power penalty increases with BER. This is due to the fact that as BER is increased the error floor starts to dominate early for certain number of antennas and thus high power penalty occurs for less values of  $fdTb$ .

It is seen clearly that for large number of antenna say  $L = 8$  the power penalty is much low compared to that of  $L = 2$  or  $4$  for different values of  $fdTb$ . For the fast fading error floors the power penalty tends to go to infinity and thus it is imperative to reduce the error floor as depicted in Table-1. It is also observed

that for higher diversity order, which is for greater value of  $L$  the error floor, occurs for much higher values of  $f_d T_b$ .

Thus in case of fast fading diversity orders greater than 4 and less than 8 might be considered optimum due to the occurrence of error floors at higher values of  $f_d T_b$ .

<b>Antenna</b>	<b>Irreducible Error floors</b>
L = 2	5.8917e-005
L = 4	1.3501e-008
L = 6	3.5006e-012
L = 8	9.579e-016

**Table-1 Irreducible Error Floor for multiple antennas**

And it can be seen from Table-1 that for diversity order greater than 4 the system might be just invulnerable from the ISI, random frequency modulation due to Doppler spread and the error floors of BER for even greater values of  $f_d T_b$  considering a BER of  $(10^{-9})$  to be optimum tolerance value for any wireless communication system.

## Chapter 5

### CONCLUSION AND FUTURE WORK

#### 5.1 Conclusion

Performance analysis is presented for a wireless mobile communication system with and without space diversity using multiple receiving and a single transmitting antenna in the presence of slow and fast Rayleigh fading. It is found that diversity offers a significant improvement in the receiver sensitivity for both the cases of slow and fast fading. It is further noticed that the improvement in receiver sensitivity at  $BER=10^{-5}$  is around 30dB when the number of receiving antennas are 6 and at  $BER=10^{-7}$  around 47 dB with the same number of antennas, further, there is a significant reduction in error floor with the application of diversity in presence of higher values of Doppler frequency shift. As studied from the analysis and results it is understood that for slowly faded channels the diversity order of 2 to 4 can be considered optimum. Beyond that the improvement in receiver sensitivity saturates for higher orders of L.

But in case of fast fading Rayleigh channels the optimum diversity order should be considered in terms of fighting the irreducible error floor. Thus high diversity order of greater than 4 could be considered as optimum. But the optimum diversity order might not be limited to the commented values because of other criterion needed to match for real time practical applications.

#### 5.2 Future Work

Our Thesis was limited consideration of the random frequency modulation by Doppler spread but further work can be done on the effect of ISI. The effect of ISI can be completely overcome by OFDM technology. Further reduction in BER

is also possible by employing a MIMO system with the OFDM channel and incorporating CDMA . Thus our work can be enhanced and developed for better performance and to create a much more Robust Communication System.

## Chapter 6

### REFERENCES

- [1] P. Y. Kam, "Bit error probabilities of MDPSK over the nonselective Rayleigh fading channel with diversity reception," *IEEE Trans. Commun.*, vol. 39, pp. 220–224, Feb. 1991.
- [2] C. D. Chung, "Differentially amplitude and phase-encoded QAM for the correlated Rayleigh-fading channel with diversity reception," *IEEE Trans. Commun.*, vol. 45, pp. 309–321, Mar. 1997.
- [3] M. Varanasi, "A systematic approach to noncoherent detection of DPSK modulation in single-user correlated diversity Rayleigh fading channels with application to post-combining decorrelative multiuser detection," presented at the Conf. Information Sciences and Systems, Baltimore, MD, Mar. 1997.
- [4] M. W. Mydlow, S. Basavaraju, and A. Duel-Hallen, "Decorrelating detector with diversity combining for single user frequency-selective Rayleigh fading multipath channels," *Int. J. Wireless Personal Commun.*, vol. 3, no. 1–2, pp. 175–193, 1996.
- [5] J. Ventura-Traveset, G. Caire, E. Biglieri, and G. Taricco, "Impact of diversity reception on fading channels with coded modulation. Part II: Differential block detection," *IEEE Trans. Commun.*, vol. 45, pp. 676–686, June 1997.
- [6] J.G. Proakis, *Digital Communications*, 4<sup>th</sup> Ed. New York: McGraw – Hill, 2001.
- [7] T.S. Rappaport, *Wireless Communications: Principles and Practice*, 2<sup>nd</sup> Ed. Prentice Hall, 2002.
- [8] Rodger E. Ziemer and Thad B. Welch, "Equal-Gain Combining of Multichannel DPSK in Doppler-Spread Ricean Fading", *IEEE*

*TRANSACTIONS ON VEHICULAR TECHNOLOGY*, VOL. 49., pp 1846 -  
1855 SEPTEMBER 2000

- [9] Andrea Goldsmith, *Wireless Communications*, Cambridge University Press, 2005
- [10] Kamilo Feher, *Wireless Digital Communications: Modulation and Spread Spectrum Applications*, New Jersey: Prentice Hall Inc., 1995.
- [11] M. Kavehrad and B. Ramamurthi, "Direct-sequence spread spectrum with DPSK modulation and diversity for indoor wireless communications," *IEEE Trans. Commun.*, vol. COM-35, pp. 224-236, Feb 1987
- [12] H. Ochsner, "Direct-sequence spread spectrum for communication on frequency-selective fading channels," *IEEE J. Select Areas Commun.*, vol SAC-5, pp. 188-193, Feb 1987
- [13] R. Price and P. E. Green, Jr., "A communication technique for multipath channels," *Proc. IRE*, vol. 46 pp 555-570, Mar. 1958.
- [14] J. K. Cavers, "On the validity of slow and moderate fading models for matched filter detection of Rayleigh fading signals," *Canad. J. Elect. Comput. Eng.*, vol. 17, pp. 183-189, 1992